



Where **high performance**
is the **standard**®



Product Catalogue
Issue 4

www.mafordeurope.com



Where **high performance** is the **standard**



Innovation is what drives us. Actively searching for fresh solutions to new technical and manufacturing challenges that enable our customers to improve productivity, accuracy and performance by relying on M.A.Ford® to deliver.

Our extensive range of tooling and 'Integrated Manufacturing Solutions' has developed and evolved to become a virtual byword for precision and performance. The principles of high precision and high quality extend beyond our tooling and are present in every aspect of M.A.Ford® Europe to ensure customer demands are consistently met at all levels.



"L'innovation est ce qui nous motive. Nous sommes constamment à la recherche de solutions techniques et d'usinage innovantes qui permettront à nos clients de surmonter les nouveaux défis dans le but d'améliorer la productivité, la précision et la performance tout en comptant sur M.A.Ford® pour répondre à leurs attentes.

Notre large gamme d'outils et de "Solutions d'Usinage Intégrées" a évolué au fil des années pour devenir à présent un synonyme de précision et de performance. Les valeurs de haute précision et de qualité haut de gamme vont au-delà de nos outils et sont présents dans chacun des aspects de M.A.Ford® Europe, nous donnant ainsi l'assurance que les exigences des consommateurs soient respectées à tous les niveaux."



Innovation ist unsere Antriebskraft. Wir suchen aktiv nach bahnbrechenden Lösungen zu neuen Herausforderungen in den Bereichen Technik und Fertigung. Auf diese Weise ermöglichen wir unseren Kunden, ihre Produktivität, Präzision und Leistungsfähigkeit zu verbessern und sich dabei voll und ganz auf M.A.Ford® zu verlassen.

Unser umfangreiches Sortiment an Werkzeugausstattungen und "integrierten Herstellungslösungen" hat sich quasi zu einem Inbegriff für Präzision und Leistungsfähigkeit entwickelt. Die Grundsätze der hohen Präzision und hochwertigen Qualität gehen weit über unsere Werkzeugausstattung hinaus und durchziehen jeden Aspekt von M.A.Ford® Europe. So stellen wir sicher, dass wir den Anforderungen unserer Kunden stets auf allen Ebenen gerecht werden.



L'innovazione è il nostro motore. La continua ricerca di soluzioni innovative per le nuove sfide tecniche e produttive, che permettono ai nostri clienti di migliorare la produttività, la precisione e la performance sapendo di poter contare su M.A.Ford®.

La nostra vasta gamma di utensili e soluzioni integrate per la produzione si è sviluppata ed evoluta fino a diventare sinonimo di precisione e prestazioni. Alta qualità e precisione sono i principi su cui si basa ogni aspetto della filosofia di M.A.Ford® Europe, che si estende al di là dei nostri utensili, per assicurare che le richieste dei nostri clienti siano costantemente soddisfatte a tutti i livelli.



Innowacyjność to jest to, co nas napędza. Aktywnie poszukujemy rozwiązań dla nowych wymagań technicznych i produkcyjnych, które umożliwiają naszym klientom poprawę produktywności, dokładności i wydajności, dzięki wdrażaniu produktów firmy M.A.Ford®.

Zintegrowane rozwiązania produkcyjne w połączeniu z naszą szeroką ofertą narzędzi stały się synonimem dla precyzji i wydajności. Precyzja i wysoka jakość łączy się w naszych narzędziach i są obecne w każdym detalu firmy M.A.Ford® Europe, aby spełniać wymagania wszystkich naszych klientów.



www.mafordeurope.com



Tel: +44 (0) 1332 267960



Email: sales@mafordeurope.com

M.A. Ford®

Achieving the outstanding cutting speeds, tool life, finish quality and overall manufacturing performance that our tooling delivers is a result of more than 100 years of experience, dedication and expertise, which has enabled us to build an enviable global reputation for performance and precision.

Every product in our range is designed to perform beyond expectations, whilst our constant process of innovative design and technological development ensures that we constantly push the boundaries of tool performance for the ultimate benefit of our customers.

FR

M.A. Ford®

“Atteindre une vitesse de coupe exceptionnelle, une longue durée de vie, une qualité de finition et une performance d’usinage générale, délivrée par nos outils, est le résultat de 100 ans d’expérience, de passion et d’expertise, qui nous ont permis de construire une enviable réputation mondiale basée sur la performance et la précision.

Chaque produit de notre gamme est conçu pour atteindre des résultats allant au-delà des attentes et notre processus permanent de conception innovante et de développement technologique nous permet de repousser constamment les limites de performance des outils dans le but de donner toujours plus d’avantages à nos clients.”

DE

M.A. Ford®

Die ausgezeichnete Schnittgeschwindigkeit, Werkzeugstandzeit, Oberflächenqualität und Gesamtfertigungsleistung unserer Werkzeuge sind das Ergebnis von über 100 Jahren Erfahrung, Engagement und Fachkompetenz, wodurch wir in der Lage waren, uns weltweit einen hervorragenden Ruf in Bezug auf Leistungsfähigkeit und Präzision zu verschaffen.

Jedes Produkt in unserem Sortiment wird mit dem Ziel konzipiert, die Erwartungen hinsichtlich der Leistungsfähigkeit zu übertreffen. Gleichzeitig ermöglicht uns der fortlaufende Prozess des innovativen Designs und der technologischen Entwicklung, stets die Möglichkeiten der Werkzeugleistung zum höchsten Nutzen unserer Kunden zu überschreiten.

IT

M.A. Ford®

Il raggiungimento di eccezionali velocità di taglio, la durata degli utensili, la qualità della finitura e le prestazioni che i nostri utensili offrono sono frutto di oltre 100 anni di esperienza, dedizione e competenza che ci hanno permesso di costruire una reputazione invidiabile a livello globale per prestazioni e precisione.

Ciascun prodotto della nostra gamma è progettato per offrire prestazioni al di là delle aspettative, il nostro processo di progettazione e sviluppo tecnologico è in continua innovazione e fa sì che limiti delle prestazioni degli utensili vengano spinti sempre più avanti, per offrire il massimo beneficio ai nostri clienti.

PL

M.A. Ford®

Osiągnięcie doskonałych prędkości skrawania, trwałości narzędzia, jakości wykończenia i ogólnej wydajności produkcji, jaką zapewniają nasze narzędzia, jest wynikiem ponad 100-letniego doświadczenia, poświęcenia i wiedzy specjalistycznej, która pozwoliła nam zbudować godną pozazdroszczenia reputację w zakresie wydajności i precyzji.

Każdy produkt w naszej ofercie zaprojektowany jest powyżej oczekiwań naszych klientów. Proces innowacyjnego projektowania i rozwoju technologicznego zapewnia, że stale podnosimy granice wydajności narzędzi, co zapewnia naszym klientom najwyższą jakość.



New Products

Carbide End Mills

	Page
TuffCut® XR - XT	16 - 44
TuffCut® X - AL	45 - 62
Technical Information	63 - 79
Carbide End Mills	81 - 95
Carbide End Mills For Aluminium	96 - 98
Technical Information	99 - 106

Routers

Diamond Grind Routers	107 - 108
Technical Information	109
Diamond Grind Routers	110 - 111
Technical Information	112

Drills

High Performance Drills	113 - 144
Technical Information	145 - 156
General Purpose Drills	157 - 179
Technical Information	180 - 184

Reamers

Reamers	185 - 195
Technical Information	196

Countersinks

Countersinks	197 - 205
Technical Information	206 - 208

Burrs

Carbide Burrs	209 - 222
Technical Information	223 - 224



15-106
End Mills
Fraise en bout
Schafffräser
Frese a Candela
Frez



107-112
Routers
Fraises Diamant
Fräser
Router
Ploutery



113-184
Drills
Forets
Bohrer
Punte
Wierła



185-196
Reamers
Alésoirs
Reibahlen
Alesatori
Pozwiertaki



197-208
Countersinks
Fraises
Senker
Svasatori
Pogłębiacze



209-224
Burrs
Fraises Limes
Frässtifte
Lime Rotative
Zadziory

NEW
Products

Nouveaux produits
Neue Produkte
Nuovi Prodotti
Nowe Produkty

TuffCut® X-AL

Series 137V5

- Vari-Helix 5 flute design enables high feed rates with reduced vibration for stable machining
- Fordlube coating prevents built up edge and increases tool-life
- Chipbreaker technology ensures excellent chip management and safer process
- Through coolant feature for rapid chip evacuation in pocketing applications



new

TuffCut® XT9

Series 380CB

- Uneven 9 flute design offers high feed rates with reduced harmonics for stable machining
- ALtima® Xtreme coating provides excellent high heat and wear resistance
- Staggered chipbreaker technology reduces cutting forces and improves chip management



new

TuffCut® XT9

Series 380L

- Stiff core technology reduces deflection for long reach applications
- Uneven 9 flute design offers high feed rates with reduced harmonics for stable machining
- ALtima® Xtreme coating provides excellent high heat and wear resistance
- 4 and 5xØ long flute versions to suit long reach profiling applications



new

TuffCut® XT9

Series 380CB L

- Stiff core technology reduces deflection for long reach applications
- Uneven 9 flute design offers high feed rates with reduced harmonics for stable machining
- ALtima® Xtreme coating provides excellent high heat and wear resistance
- 4 and 5xØ long flute versions to suit long reach profiling applications



new

TuffCut® XT9

Series 380 N4 - N5

- Stiff core technology reduces deflection for long reach applications
- Uneven 9 flute design offers high feed rates with reduced harmonics for stable machining
- ALtima® Xtreme coating provides excellent high heat and wear resistance
- 4 and 5xØ reach necked versions to suit long reach profiling applications
- Staggered chipbreaker technology reduces cutting forces and improves chip management



new

TuffCut® XT9

Series 380CB N4 - N5

- Stiff core technology reduces deflection for long reach applications
- Uneven 9 flute design offers high feed rates with reduced harmonics for stable machining
- ALtima® Xtreme coating provides excellent high heat and wear resistance
- 4 and 5xØ reach necked versions to suit long reach profiling applications
- Staggered chipbreaker technology reduces cutting forces and improves chip management



new

NEW
Products

Nouveaux produits
Neue Produkte
Nuovi Prodotti
Nowe Produkty

TuffCut® GP

Series FBPM

- 254° Spherical Ball designed for 5 axis machining, undercutting and deburring
- ALtima® Xtreme coating works in wide range of material groups



new

TuffCut® GP

Series FBCM

- Multi flutes for increased feed and improved surface finish
- Dual angled cutting edges deburrs and chamfers front and back of surfaces
- ALtima® Xtreme coating works in wide range of material groups



new

TuffCut® 3D

Series 250

- High performance geometry for roughing and finishing applications
- Radius tolerance + 0.010mm for accurate finishing in 3D shapes
- ALtima® Blaze coating for machining hardened steels <50HRC - alloy steel - stainless steel - titanium
- Economical price level reduces tooling costs



new

TuffCut®

Series 5HC

- Helical flute form gives a smooth cutting action, higher feed and improved surface finish
- Precision flat tip diameter for increased strength, easy programming and excellent repeatability
- ALtima® Blaze coating works in extensive material range and offers increased tool-life



new

TuffCut® X-AL

Series 137V N3, N4 & N5 AL

Designed to deliver exceptional metal removal rates and chip evacuation on aluminium, aluminium alloys and non-ferrous materials

- New end cut geometry allows plunge machining into solid material (max 1xD)
- Unique variable helix for vibration free machining at high feeds and depths of cut
- Roughing and finishing applications
- Fordlube coating increases tool-life and reduces chip adhesion



new items

Twister® HPD 3xD

Series HPDSS, HPDCS

Economical choice perfect for contract machining and small batch production requiring a high-performance drill

- Wide material application area for Steels, Stainless Steels, Cast Irons, Titanium & Heat resistant alloys
- Self centring point which eliminates the need for spot drilling
- h7 tolerance making precision holes
- h6 shank tolerance for shrink fit applications



new items

Range Extension - See page 53 - 58

Range Extension - See page 165 - 167

TuffCut® X-AL Series 137V5

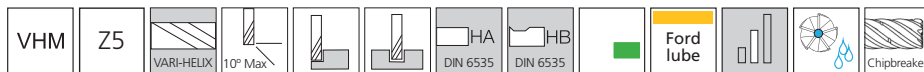

Close up of chipbreaker grind



Cylindrical Shank (HA)

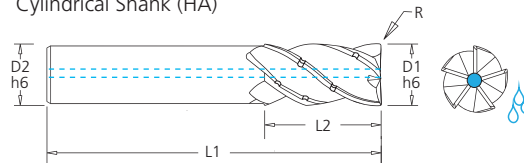

Weldon Shank (HB)

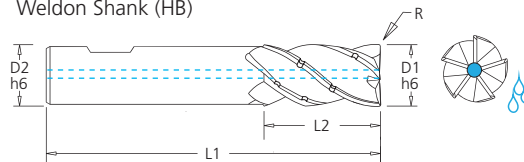

Cylindrical Shank (HA)

Tool Number	D1	D2	L1	L2	R
137V5 1003-ALCC	10.0	10.0	75.0	32.0	-
137V5 1003-1.0RALCC	10.0	10.0	75.0	32.0	1.0
137V5 1203-ALCC	12.0	12.0	87.0	38.0	-
137V5 1203-1.0RALCC	12.0	12.0	87.0	38.0	1.0
137V5 1203-3.0RALCC	12.0	12.0	87.0	38.0	3.0
137V5 1603-ALCC	16.0	16.0	104.0	50.0	-
137V5 1603-1.0RALCC	16.0	16.0	104.0	50.0	1.0
137V5 1603-3.0RALCC	16.0	16.0	104.0	50.0	3.0
137V5 2003-ALCC	20.0	20.0	120.0	62.0	-
137V5 2003-1.0RALCC	20.0	20.0	120.0	62.0	1.0

Weldon Shank (HB)

Tool Number	D1	D2	L1	L2	R
137V5 1003-ALCCW	10.0	10.0	75.0	32.0	-
137V5 1003-1.0RALCCW	10.0	10.0	75.0	32.0	1.0
137V5 1203-ALCCW	12.0	12.0	87.0	38.0	-
137V5 1203-1.0RALCCW	12.0	12.0	87.0	38.0	1.0
137V5 1603-ALCCW	16.0	16.0	104.0	50.0	-
137V5 1603-1.0RALCCW	16.0	16.0	104.0	50.0	1.0
137V5 2003-ALCCW	20.0	20.0	120.0	62.0	-
137V5 2003-1.0RALCCW	20.0	20.0	120.0	62.0	1.0

Recommended cutting data

Series	Type of cut		Vc	Diameter - mm				
				10.0	12.0	16.0	20.0	
	Ae	Ap	m/min	fz	fz	fz	fz	
137V5 3 x D		0.1 x D	3 x D	300-1000	0.1	0.12	0.16	0.2
		0.15 x D	3 x D	300-1000	0.1	0.12	0.16	0.2
		0.2 x D	3 x D	300-1000	0.1	0.12	0.16	0.2
		0.3 x D	2 x D	300-1000	0.1	0.12	0.16	0.2
137V5 1 x D		1 x D	1 x D Max	300-1000	0.05	0.06	0.08	0.1

Radial Cut (Ae)	Chip thickness Compensation factor
30%	1.10
20%	1.20
15%	1.40
10%	1.80
5%	2.30
1%	5.00

Note:

Ramping (10° max) to 3 x D at slotting feed rates.

To achieve the highest torque when using this tool on low powered machines, the rpm may need to be adjusted.

When using higher Ae please ensure to use an appropriate chuck with sufficient clamping pressure.

During profile milling less than 50% of the cutter diameter radial width, the actual chip thickness at the cutting edge is less than the programmed chipload.

The accompanying table shows the increase in tooth load by given radial percentage engagement. Multiply your feed per tooth by the factor before finalising your table feed.

TuffCut® XT9 Series 380CB

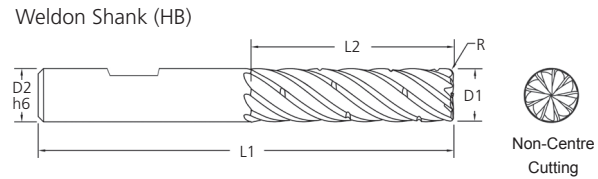
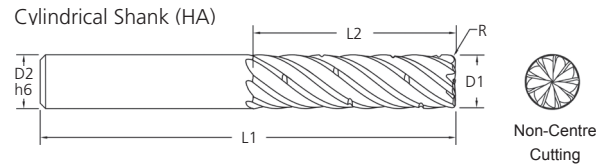
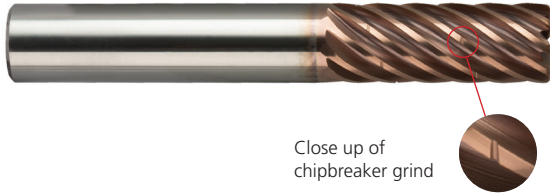

Cylindrical Shank (HA)

Tool No.	D1	D2	L1	L2	R
380CBM0800-0.5RAX	8.0	8.0	63.0	22.0	0.5
380CBM0800-1.0RAX	8.0	8.0	63.0	22.0	1.0
380CBM1000-0.5RAX	10.0	10.0	72.0	27.0	0.5
380CBM1000-1.0RAX	10.0	10.0	72.0	27.0	1.0
380CBM1200-0.5RAX	12.0	12.0	81.0	32.0	0.5
380CBM1200-1.0RAX	12.0	12.0	81.0	32.0	1.0
380CBM1600-0.5RAX	16.0	16.0	92.0	42.0	0.5
380CBM1600-1.0RAX	16.0	16.0	92.0	42.0	1.0
380CBM2000-0.5RAX	20.0	20.0	104.0	52.0	0.5
380CBM2000-1.0RAX	20.0	20.0	104.0	52.0	1.0

Weldon Shank (HB)

Tool No.	D1	D2	L1	L2	R
380CBM0800-0.5RAXW	8.0	8.0	63.0	22.0	0.5
380CBM0800-1.0RAXW	8.0	8.0	63.0	22.0	1.0
380CBM1000-0.5RAXW	10.0	10.0	72.0	27.0	0.5
380CBM1000-1.0RAXW	10.0	10.0	72.0	27.0	1.0
380CBM1200-0.5RAXW	12.0	12.0	81.0	32.0	0.5
380CBM1200-1.0RAXW	12.0	12.0	81.0	32.0	1.0
380CBM1600-0.5RAXW	16.0	16.0	92.0	42.0	0.5
380CBM1600-1.0RAXW	16.0	16.0	92.0	42.0	1.0
380CBM2000-0.5RAXW	20.0	20.0	104.0	52.0	0.5
380CBM2000-1.0RAXW	20.0	20.0	104.0	52.0	1.0

NEW Products
 Nouveaux produits
 Neue Produkte
 Nuovi Prodotti
 Nowe Produkty

TuffCut® XT9 Series 380CB, 380CB-W

Recommended cutting data | Conditions de coupe recommandées | Empfohlene Schnittdaten | Dati di taglio Raccomandati | Zalecane Parametry

NEW Products

Nouveaux produits
Neue Produkte
Nuovi Prodotti
Nowe Produkty

Workpiece Material Group	ISO	Hardness	Coolant			Profiling (ae)		End Mill Diameter (mm)				
			● Preferred ○ Possible x Not Possible					8	10	12	16	20
						2.3	1.67	← Multiply fz by this Factor based on ae. When finishing, use the standard fz per chart below. Only add chip thinning when roughing or semi-finishing.				
			Max.	Air	MMS	vc - m/min	fz - mm/tooth					
Low Carbon Steels 1018, 1020	P	up to 28 Rc	●	●	●	450	350	.080	.100	.110	.150	.254
Medium Carbon Steels 1140, 1145	P	28 to 38 Rc	●	●	●	345	275	.080	.100	.110	.150	.254
Alloy Steels 4140, 4145	P	28 to 44 Rc	●	●	●	315	255	.080	.100	.110	.150	.254
Die / Tool Steels A2, D2, H13, P20	P	28 to 44 Rc	●	●	●	275	220	.080	.100	.110	.150	.254
Stainless Steel - Easy to Machine 430F, 301, 303, 410, 416 Annealed, 420F, 430	M	up to 28 Rc	●	x	○	205	165	.030-.040	.038-.050	.050-.078	.050-.083	.060-.099
Stainless Steel - Austenitic 301, 302, 303 High Tensile, 304, 304L, 305, 420, 15-5PH, 17-4PH, 17-7PH	M	up to 28 Rc	●	x	○	160	130	.030-.040	.038-.050	.050-.078	.050-.083	.060-.099
Stainless Steel - Difficult to Machine 302B, 304B, 309, 310, 316, 316B, 316L, 316Ti, 317, 317L, 321	M	up to 28 Rc	●	x	○	125	100	.030-.040	.038-.050	.050-.078	.050-.083	.060-.099
Stainless Steel - Difficult to Machine 17-4 PH, PH13-8Mo, Nitronics	M		●	x	○	160	130	.030-.040	.038-.050	.050-.078	.050-.083	.060-.099
Cobalt Chrome Alloys	M	over 28 Rc	●	x	○	125	100	.040	.050	.078	.083	.099
Duplex (22%)	M		●	x	○	75	60	.040	.050	.078	.083	.099
Super Duplex (25%)	M		●	x	○	75	60	.040	.050	.078	.083	.099
High Temp Alloys	S	up to 42 Rc	●	x	x	55	45	.030-.040	.038-.050	.025-.040	.025-.043	.030-.050
Inconel	S		●	x	x	55	45	.020-.030	.025-.040	.025-.040	.025-.043	.030-.050
Titanium Alloys 6Al-4V, 5Al-2.5 Sn, 6Al-2 Sn-4Zr-6Mo, 3Al-8V-6Cr-4Mo-4Zr, 10V-2Fe-3Al, 13V-11Cr-3Al	S	up to 42 Rc	●	x	x	115	105	.020-.030	.025-.040	.050-.078	.050-.083	.030-.050
Cast Iron - Gray CG, ASTM A48, CLASS 20, 25, 30, 35, SAE J431C, GRADES G1800, G3000, G3500, GG 10, 15, 20, 25, 30, 35, 40	K	up to 240 HB	●	○	○	495	395	.080	.100	.110	.150	.254
Cast Iron - Ductile & Malleable CGI 60-40-18, 65-45-12, D4018, D4512, D5506, 32510, 35108, M3210, M4504, M5503, 250, 300, 350, 400, 450	K	over 240 HB	●	○	○	205	165	.065	.080	.110	.150	.254
Hardened Steels		40-50 Rc	●	○	○	185	150	.050	.060	.101	.116	.152
Hardened Steels	H	50-55 Rc	●	○	○	155	125	.030	.040	.061	.076	.088
Hardened Steels		>55 Rc	●	○	○	100	95	.020	.025	.045	.055	.063

Safety Note

Always wear the appropriate personal protective equipment such as safety glasses and protective clothing when using solid carbide or HSS cutting tools. Machines should be fully guarded.

Spindle Maximum - Should the calculated spindle speed be more than your actual spindle maximum, use this formula:
(Calculated Feed x Spindle Maximum)/Calculated Speed.

Technical data provided should be considered advisory only as variations may be necessary depending on the particular application.

TuffCut® XT9 Series 380L

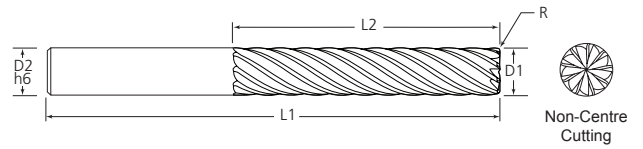
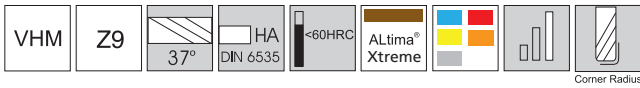

Tool Number	D1	D2	L1	L2	R
380M1204-1.0RAX	12.0	12.0	100.0	50.0	1.0
380M1205-1.0RAX	12.0	12.0	120.0	62.0	1.0
380M1604-1.0RAX	16.0	16.0	120.0	66.0	1.0
380M1605-1.0RAX	16.0	16.0	150.0	82.0	1.0

TuffCut® XT9 Series 380CB L



Close up of chipbreaker grind

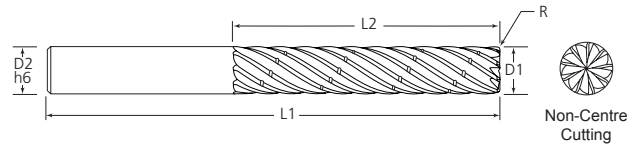

Tool Number	D1	D2	L1	L2	R
380CBM1204-1.0RAX	12.0	12.0	100.0	50.0	1.0
380CBM1205-1.0RAX	12.0	12.0	120.0	62.0	1.0
380CBM1604-1.0RAX	16.0	16.0	120.0	66.0	1.0
380CBM1605-1.0RAX	16.0	16.0	150.0	82.0	1.0

TuffCut® XT9 Series 380 N4 & N5



NEW Products

Nouveaux produits
Neue Produkte
Nuovi Prodotti
Nowe Produkty

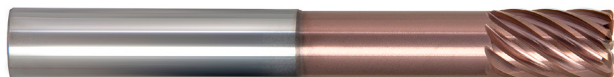

Cylindrical Shank (HA)

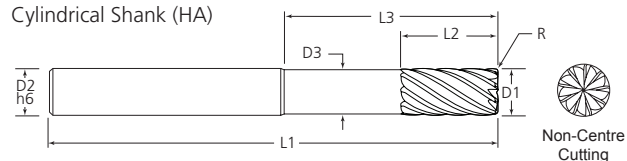

Weldon Shank (HB)

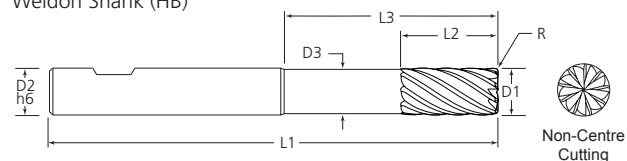

Cylindrical Shank (HA)

Tool Number	D1	D2	D3	L1	L2	L3	R
380M1200N4-1.0RAX	12.0	12.0	11.4	100.0	18.0	50.0	1.0
380M1200N5-1.0RAX	12.0	12.0	11.4	110.0	18.0	62.0	1.0
380M1600N4-1.0RAX	16.0	16.0	15.2	120.0	35.0	66.0	1.0
380M1600N5-1.0RAX	16.0	16.0	15.2	133.0	35.0	82.0	1.0

Weldon Shank (HB)

Tool Number	D1	D2	D3	L1	L2	L3	R
380M1200N4-1.0RAXW	12.0	12.0	11.4	100.0	18.0	50.0	1.0
380M1200N5-1.0RAXW	12.0	12.0	11.4	110.0	18.0	62.0	1.0
380M1600N4-1.0RAXW	16.0	16.0	15.2	120.0	35.0	66.0	1.0
380M1600N5-1.0RAXW	16.0	16.0	15.2	133.0	35.0	82.0	1.0

TuffCut® XT9 Series 380CB N4 - N5

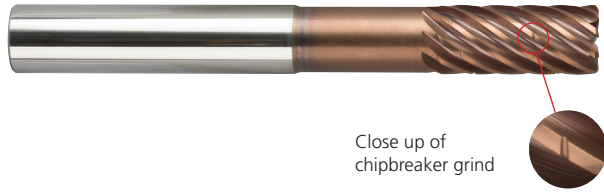
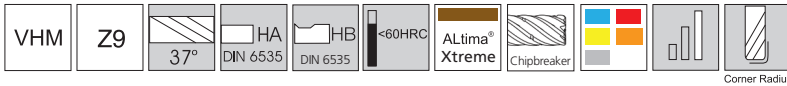

Cylindrical Shank (HA)

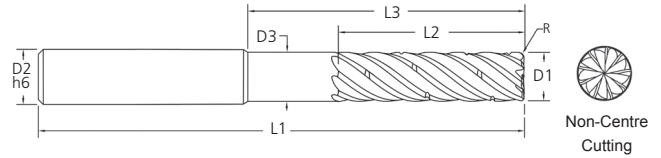

Weldon Shank (HB)

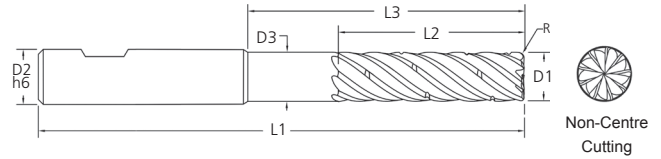

Cylindrical Shank (HA)

Tool No.	D1	D2	D3	L1	L2	L3	R
380CBM12N4-1.0RAX	12.0	12.0	11.4	100.0	27.0	50.0	1.0
380CBM12N5-1.0RAX	12.0	12.0	11.4	110.0	27.0	62.0	1.0
380CBM16N4-1.0RAX	16.0	16.0	15.2	120.0	35.0	66.0	1.0
380CBM16N5-1.0RAX	16.0	16.0	15.2	133.0	35.0	82.0	1.0

Weldon Shank (HB)

Tool Number	D1	D2	D3	L1	L2	L3	R
380CBM12N4-1.0RAXW	12.0	12.0	11.4	100.0	27.0	50.0	1.0
380CBM12N5-1.0RAXW	12.0	12.0	11.4	110.0	27.0	62.0	1.0
380CBM16N4-1.0RAXW	16.0	16.0	15.2	120.0	35.0	66.0	1.0
380CBM16N5-1.0RAXW	16.0	16.0	15.2	133.0	35.0	82.0	1.0

NEW Products

Nouveaux produits
Neue Produkte
Nuovi Prodotti
Nowe Produkty

TuffCut® XT9 Series 380L, 380CB L, 380N4 & N5 - W & 380CB N4 & N5 - W

Recommended cutting data | Conditions de coupe recommandées | Empfohlene Schnittdaten | Dati di taglio Raccomandati | Zalecane Parametry

NEW Products
Nouveaux produits
Neue Produkte
Nuovi Prodotti
Nowe Produkty

Workpiece Material Group	ISO	Hardness	Coolant ● Preferred ○ Possible x Not Possible			Profiling (ae)			End Mill Diameter (mm)	
			Max.	Air	MMS	5%	7%	10%	12	16
						2.3	2.0	1.8	← Multiply fz by this Factor based on ae. When finishing, use the standard fz per chart below. Only add chip thinning when roughing or semi-finishing.	
									vc - m/min	
Low Carbon Steels 1018, 1020	P	up to 28 Rc	●	●	●	385	350	310	0.050	0.060
Medium Carbon Steels 1140, 1145	P	28 to 38 Rc	●	●	●	250	230	200	0.050	0.060
Alloy Steels 4140, 4145	P	28 to 44 Rc	●	●	●	250	230	200	0.050	0.060
Die / Tool Steels A2, D2, H13, P20	P	28 to 44 Rc	●	●	●	220	200	180	0.050	0.060
Stainless Steel - Easy to Machine 430F, 301, 303, 410, 416 Annealed, 420F, 430	M	up to 28 Rc	●	x	○	165	150	130	0.050	0.060
Stainless Steel - Austenitic 301, 302, 303 High Tensile, 304, 304L, 305, 420, 15-5PH, 17-4PH, 17-7PH	M	up to 28 Rc	●	x	○	130	120	100	0.050	0.060
Stainless Steel - Difficult to Machine 302B, 304B, 309, 310, 316, 316B, 316L, 316Ti, 317, 317L, 321	M	up to 28 Rc	●	x	○	100	90	80	0.050	0.060
Stainless Steel - Difficult to Machine 17-4 PH, PH13-8Mo, Nitronics	M	over 28 Rc	●	x	○	100	90	80	0.050	0.060
Cobalt Chrome Alloys	M		●	x	○	100	90	80	0.050	0.060
Duplex (22%)	M		●	x	○	60	50	45	0.050	0.060
Super Duplex (25%)	M		●	x	○	60	50	45	0.050	0.060
High Temp Alloys	S	up to 42 Rc	●	x	x	45	40	35	0.050	0.060
Inconel	S	up to 42 Rc	●	x	x	45	40	35	0.025	0.030
Titanium Alloys 6Al-4V, 5Al-2.5 Sn, 6Al-2 Sn-4Zr-6Mo, 3Al-8V-6Cr4Mo-4Zr,	S	up to 42 Rc	●	x	x	90	85	80	0.030	0.040
Cast-Iron - Gray CG, ASTM A48, CLASS 20, 25, 30, 35, SAE J431C, GRADES G1800, G3000, G3500, GG 10, 15, 20, 25, 30, 35, 40	K	up to 240 HB	●	○	○	395	355	315	0.050	0.060
Cast Iron - Ductile & Malleable CGI 60-40-18, 65-45-12, D4018, D4512, D5506, 32510, 35108, M3210, M4504, M5503, 250, 300, 350, 400, 450	K	over 240 HB	●	○	○	165	150	130	0.050	0.060
Hardened Steels	H	40-50 Rc	●	○	○	150	130	120	0.040	0.050
Hardened Steels		50-55 Rc	●	○	○	125	110	100	0.025	0.030
Hardened Steels		>55 Rc	●	○	○	80	75	75	0.020	0.025

Safety Note

Always wear the appropriate personal protective equipment such as safety glasses and protective clothing when using solid carbide or HSS cutting tools. Machines should be fully guarded.

Spindle Maximum - Should the calculated spindle speed be more than your actual spindle maximum, use this formula: (Calculated Feed x Spindle Maximum)/Calculated Speed.

Technical data provided should be considered advisory only as variations may be necessary depending on the particular application.

TuffCut® GP Series FBPM

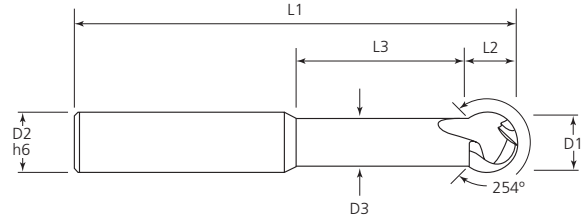
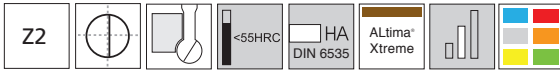

NEW Products

Nouveaux produits
Neue Produkte
Nuovi Prodotti
Nowe Produkty

Tool Number	D1	D2	D3	L1	L2	L3	R
FBPM 03N3H	3.0	4.0	2.4	50.0	2.5	9.0	R1.5
FBPM 04N3H	4.0	4.0	3.2	50.0	3.5	11.5	R2.0
FBPM 05N3H	5.0	6.0	4.0	57.0	4.5	14.0	R2.5
FBPM 06N3H	6.0	6.0	4.8	64.0	5.4	16.6	R3.0
FBPM 08N3H	8.0	8.0	6.4	63.0	7.4	21.6	R4.0
FBPM 10N3H	10.0	10.0	8.0	72.0	9.4	26.6	R5.0
FBPM 12N3H	12.0	12.0	9.6	83.0	11.4	31.6	R6.0

TuffCut® GP Series FBPM

Recommended cutting data | Conditions de coupe recommandées | Empfohlene Schnittdaten | Dati di taglio Raccomandati | Zalecane Parametry

Recommended Speeds and Depths of Cut by Material Group

Workpiece Material Group	Material Type	Ap			Roughing	Finishing	
		Ae			0.05 - 0.1 x D	0.02 - 0.05 x D	
		Coolant			0.2 - 0.3 x D	0.02 - 0.05 x D	
		Max	Air	MMS			Vc-m/min
Steels	P	Low Carbon Steels ≤180HB	○	●	●	250	280
		Med Carbon / Alloy Steels 180-350HB	○	●	●	200	220
		Pre-Hardened Steels 35-45HRC	○	●	●	180	200
Stainless Steels	M	Free Machining Stainless	●	○	○	160	180
		Austenitic Stainless	●	○	○	130	150
		Difficult Stainless	●	○	○	100	110
Special Alloys	S	High Temp Alloys	●	X	X	50	55
		Titanium Alloys	●	X	X	110	120
Cast Irons	K	Grey Cast Iron	○	●	X	220	250
		Ductile Cast Iron	○	●	X	180	200
Hardened Steels	H	Hardened Steels 45 - 50HRC	○	●	○	160	170
Non-Ferrous	N	Aluminium Alloys	●	X	○	300	500
		Brass / Bronze / Copper	●	X	○	250	400

● Preferred ○ Possible X Not Possible

Recommended Feed per Tooth by Material Group

Workpiece Material Group	Material Type	Tool Diameter & Radius (mm)								
		3		4		5		6		
		1.5		2		2.5		3		
		Rough	Finish	Rough	Finish	Rough	Finish	Rough	Finish	
Steels	P	Low Carbon Steels ≤180HB	0.060	0.045	0.080	0.060	0.100	0.075	0.120	0.090
		Med Carbon / Alloy Steels 180-350HB	0.060	0.045	0.080	0.060	0.100	0.075	0.120	0.090
		Pre-Hardened Steels 35-45HRC	0.054	0.045	0.072	0.060	0.090	0.075	0.108	0.090
Stainless Steels	M	Free Machining Stainless	0.054	0.045	0.072	0.060	0.090	0.075	0.108	0.090
		Austenitic Stainless	0.045	0.045	0.060	0.060	0.075	0.075	0.090	0.090
		Difficult Stainless	0.045	0.045	0.060	0.060	0.075	0.075	0.090	0.090
Special Alloys	S	High Temp Alloys	0.024	0.030	0.032	0.040	0.040	0.050	0.048	0.060
		Titanium Alloys	0.036	0.030	0.048	0.040	0.060	0.050	0.072	0.060
Cast Irons	K	Grey Cast Iron	0.060	0.045	0.080	0.060	0.100	0.075	0.120	0.090
		Ductile Cast Iron	0.054	0.045	0.072	0.060	0.090	0.075	0.108	0.090
Hardened Steels	H	Hardened Steels 45 - 50HRC	0.039	0.038	0.052	0.050	0.065	0.063	0.078	0.075
Non-Ferrous	N	Aluminium Alloys	0.075	0.045	0.100	0.060	0.125	0.075	0.150	0.090
		Brass / Bronze / Copper	0.060	0.045	0.080	0.060	0.100	0.075	0.120	0.090

Workpiece Material Group	Material Type	Tool Diameter & Radius (mm)						
		8		10		12		
		4		5		6		
		Rough	Finish	Rough	Finish	Rough	Finish	
Steels	P	Low Carbon Steels ≤180HB	0.160	0.120	0.200	0.150	0.240	0.180
		Med Carbon / Alloy Steels 180-350HB	0.160	0.120	0.200	0.150	0.240	0.180
		Pre-Hardened Steels 35-45HRC	0.144	0.120	0.180	0.150	0.216	0.180
Stainless Steels	M	Free Machining Stainless	0.144	0.120	0.180	0.150	0.216	0.180
		Austenitic Stainless	0.120	0.120	0.150	0.150	0.180	0.180
		Difficult Stainless	0.120	0.120	0.150	0.150	0.180	0.180
Special Alloys	S	High Temp Alloys	0.064	0.080	0.080	0.100	0.096	0.120
		Titanium Alloys	0.096	0.080	0.120	0.100	0.144	0.120
Cast Irons	K	Grey Cast Iron	0.160	0.120	0.200	0.150	0.240	0.180
		Ductile Cast Iron	0.144	0.120	0.180	0.150	0.216	0.180
Hardened Steels	H	Hardened Steels 45 - 50HRC	0.104	0.100	0.130	0.125	0.156	0.150
Non-Ferrous	N	Aluminium Alloys	0.200	0.120	0.250	0.150	0.300	0.180
		Brass / Bronze / Copper	0.160	0.120	0.200	0.150	0.240	0.180

TuffCut® GP Series FBCM

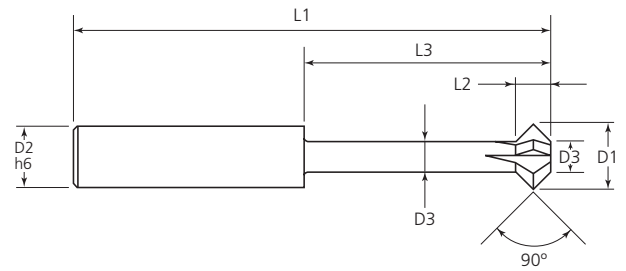

Tool Number	D1	D2	D3	L1	L2	L3	Z	Max CHF
FBCM 03N3H	3.0	4.0	1.5	50.0	1.5	11.5	3	0.6
FBCM 04N3H	4.0	4.0	2.0	50.0	2.0	15.0	3	0.9
FBCM 05N3H	5.0	6.0	2.5	57.0	2.5	18.5	3	1.1
FBCM 06N3H	6.0	6.0	3.0	64.0	3.0	22.0	3	1.4
FBCM 08N3H	8.0	8.0	4.0	63.0	4.0	29.0	4	1.8
FBCM 10N3H	10.0	10.0	5.0	72.0	5.0	36.0	5	2.3
FBCM 12N3H	12.0	12.0	6.0	83.0	6.0	43.0	5	2.8

Front chamfer

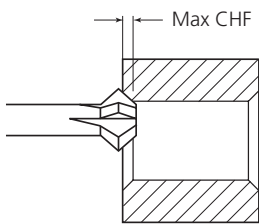

Back chamfer

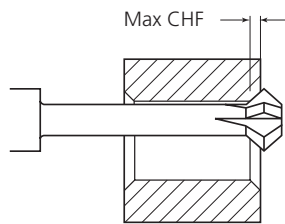

NEW
Products

Nouveaux produits
 Neue Produkte
 Nuovi Prodotti
 Nowe Produkty

TuffCut® GP Series FBCM

Recommended cutting data | Conditions de coupe recommandées | Empfohlene Schnittdaten | Dati di taglio Raccomandati | Zalecane Parametry

Recommended Speeds by Material Group

Workpiece Material Group	Material Type	Coolant			Deburr	Chamfer	
		Max	Air	MMS	Vc-m/min		
Steels	P	Low Carbon Steels	●	●	●	230	220
		Medium Carbon Steels	●	●	●	200	185
		Alloy Tool Steels	●	●	●	175	165
		Die/Tool Steels	●	●	●	145	130
Stainless Steels	M	Free Machining Stainless	●	X	○	120	110
		Austenitic Stainless	●	X	○	110	100
		Difficult Stainless	●	X	○	75	65
		PH Stainless	●	X	○	110	100
		Cobalt Chrome Alloys	●	X	○	75	65
		Duplex (22%)	●	X	○	75	65
		Super Duplex (25%)	●	X	○	55	45
Special Alloys	S	High Temp Alloys	●	X	X	35	28
		Titanium Alloys	●	X	X	75	66
Cast Irons	K	Grey Cast Iron	●	○	○	200	175
		Ductile Cast Iron	●	○	○	185	165
Hardened Steels	H	Hardened Steels 45 - 50HRC	○	●	○	60	50
		Hardened Steels 50 - 55HRC	○	●	○	50	45
Non Ferrous	N	Aluminium Alloys	●	X	○	300	250
		Brass / Bronze / Copper	●	X	○	180	170

Please note:

Use the following formula to calculate the effective cutting diameter:
 (Major diameter D1 + minor diameter D3) / 2.

Alternatively, estimate the actual diameter that is in contact with the workpiece.

● Preferred ○ Possible X Not Possible

Recommended Feed per Tooth by Material Group

Workpiece Material Group	Type of Machining	Tool Diameter							
		3mm	4mm	5mm	6mm	8mm	10mm	12mm	
		fz-mm/tooth							
Steels	P	Deburr	0.015	0.020	0.025	0.030	0.040	0.050	0.060
		Chamfer	0.008	0.010	0.013	0.015	0.020	0.025	0.030
Stainless Steels	M	Deburr	0.015	0.020	0.025	0.030	0.040	0.050	0.060
		Chamfer	0.008	0.010	0.013	0.015	0.020	0.025	0.030
High Temp Alloys	S	Deburr	0.004	0.006	0.007	0.016	0.019	0.022	0.026
		Chamfer	0.002	0.003	0.004	0.008	0.010	0.011	0.013
Titanium	S	Deburr	0.015	0.020	0.025	0.030	0.040	0.050	0.060
		Chamfer	0.008	0.010	0.013	0.015	0.020	0.025	0.030
Cast Irons	K	Deburr	0.015	0.020	0.025	0.030	0.040	0.050	0.060
		Chamfer	0.008	0.010	0.013	0.015	0.020	0.025	0.030
Hardened Steels 45 - 50HRC	H	Deburr	0.010	0.013	0.015	0.025	0.035	0.045	0.054
		Chamfer	0.005	0.007	0.008	0.013	0.018	0.023	0.027
Hardened Steels 50 - 55HRC	H	Deburr	0.008	0.010	0.011	0.020	0.030	0.040	0.050
		Chamfer	0.004	0.005	0.006	0.010	0.015	0.020	0.025
Non Ferrous	N	Deburr	0.015	0.020	0.025	0.030	0.040	0.050	0.050
		Chamfer	0.008	0.010	0.013	0.015	0.020	0.025	0.025

Please note: These are recommended starting conditions. However, please adjust the feed to suit the surface finish requirements.

TuffCut® 3D Series 250

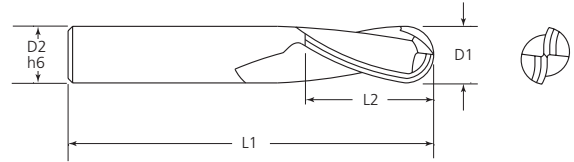
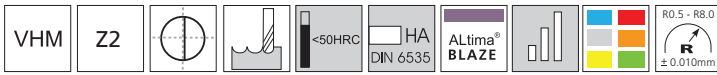

Tool Number	D1	R	D2	L1	L2
250M01041B	1.0	0.5	4.0	50.0	2.0
250M015041B	1.5	0.75	4.0	50.0	3.0
250M02041B	2.0	1.0	4.0	50.0	4.0
250M03041B	3.0	1.5	4.0	50.0	6.0
250M04041B	4.0	2.0	4.0	50.0	6.0
250M04061B	4.0	2.0	6.0	50.0	6.0
250M05061B	5.0	2.5	6.0	50.0	7.5
250M06061B	6.0	3.0	6.0	50.0	9.0
250M06062B	6.0	3.0	6.0	75.0	9.0
250M06063B	6.0	3.0	6.0	100.0	12.0
250M08081B	8.0	4.0	8.0	63.0	12.0
250M08082B	8.0	4.0	8.0	75.0	12.0
250M08083B	8.0	4.0	8.0	100.0	16.0
250M10101B	10.0	5.0	10.0	75.0	15.0
250M10102B	10.0	5.0	10.0	100.0	20.0
250M12121B	12.0	6.0	12.0	75.0	18.0
250M12122B	12.0	6.0	12.0	100.0	24.0
250M16161B	16.0	8.0	16.0	75.0	24.0
250M16162B	16.0	8.0	16.0	100.0	32.0

NEW Products
 Nouveaux produits
 Neue Produkte
 Nuovi Prodotti
 Nowe Produkty

TuffCut® 3D Series 250

Recommended cutting data | Conditions de coupe recommandées | Empfohlene Schnittdaten | Dati di taglio Raccomandati | Zalecane Parametry

NEW Products

Nouveaux produits
Neue Produkte
Nuovi Prodotti
Nowe Produkty

Workpiece Material Group	Material Type	Ap			Roughing	Finishing	
		Ae			0.05 - 0.1 x D	0.02 - 0.05 x D	
		Coolant			Vc-m/min		
		Max	Air	MMS			
Steels	P	Low Carbon Steels ≤180HB	○	●	●	250	280
		Med Carbon / Alloy Steels 180-350HB	○	●	●	200	220
		Pre-Hardened Steels 35-45HRC	○	●	●	180	200
Stainless Steels	M	Free Machining Stainless	●	○	○	160	180
		Austenitic Stainless	●	○	○	130	150
		Difficult Stainless	●	○	○	100	110
Special Alloys	S	High Temp Alloys	●	X	X	50	55
		Titanium Alloys	●	X	X	110	120
Cast Irons	K	Grey Cast Iron	○	●	X	220	250
		Ductile Cast Iron	○	●	X	180	200
Hardened Steels	H	Hardened Steels 45 - 50HRC	○	●	○	160	170
Non-Ferrous	N	Aluminium Alloys	●	X	○	300	500
		Brass / Bronze / Copper	●	X	○	250	400

● Preferred ○ Possible X Not Possible

Recommended Feed per Tooth by Material Group

Workpiece Material Group	Material Type	Tool Diameter & Radius												
		1		1.5		2		3		4		5		
		0.5		0.75		1		1.5		2		2.5		
		Rough	Finish	Rough	Finish	Rough	Finish	Rough	Finish	Rough	Finish	Rough	Finish	
Steels	P	Low Carbon Steels ≤180HB	0.020	0.015	0.030	0.023	0.040	0.030	0.060	0.045	0.080	0.060	0.100	0.075
		Med Carbon / Alloy Steels 180-350HB	0.020	0.015	0.030	0.023	0.040	0.030	0.060	0.045	0.080	0.060	0.100	0.075
		Pre-Hardened Steels 35-45HRC	0.018	0.015	0.027	0.023	0.036	0.030	0.054	0.045	0.072	0.060	0.090	0.075
Stainless Steels	M	Free Machining Stainless	0.018	0.015	0.027	0.023	0.036	0.030	0.054	0.045	0.072	0.060	0.090	0.075
		Austenitic Stainless	0.015	0.015	0.023	0.023	0.030	0.030	0.045	0.045	0.060	0.060	0.075	0.075
		Difficult Stainless	0.015	0.015	0.023	0.023	0.030	0.030	0.045	0.045	0.060	0.060	0.075	0.075
Special Alloys	S	High Temp Alloys	0.008	0.010	0.012	0.015	0.016	0.020	0.024	0.030	0.032	0.040	0.040	0.050
		Titanium Alloys	0.012	0.010	0.018	0.015	0.024	0.020	0.036	0.030	0.048	0.040	0.060	0.050
Cast Irons	K	Grey Cast Iron	0.020	0.015	0.030	0.023	0.040	0.030	0.060	0.045	0.080	0.060	0.100	0.075
		Ductile Cast Iron	0.018	0.015	0.027	0.023	0.036	0.030	0.054	0.045	0.072	0.060	0.090	0.075
Hardened Steels	H	Hardened Steels 45 - 50HRC	0.013	0.013	0.020	0.019	0.026	0.025	0.039	0.038	0.052	0.050	0.065	0.063
Non-Ferrous	N	Aluminium Alloys	0.025	0.015	0.038	0.023	0.050	0.030	0.075	0.045	0.100	0.060	0.125	0.075
		Brass / Bronze / Copper	0.020	0.015	0.030	0.023	0.040	0.030	0.060	0.045	0.080	0.060	0.100	0.075

Workpiece Material Group	Material Type	Tool Diameter & Radius										
		6		8		10		12		16		
		3		4		5		6		8		
		Rough	Finish	Rough	Finish	Rough	Finish	Rough	Finish	Rough	Finish	
Steels	P	Low Carbon Steels ≤180HB	0.120	0.090	0.160	0.120	0.200	0.150	0.240	0.180	0.320	0.240
		Med Carbon / Alloy Steels 180-350HB	0.120	0.090	0.160	0.120	0.200	0.150	0.240	0.180	0.320	0.240
		Pre-Hardened Steels 35-45HRC	0.108	0.090	0.144	0.120	0.180	0.150	0.216	0.180	0.288	0.240
Stainless Steels	M	Free Machining Stainless	0.108	0.090	0.144	0.120	0.180	0.150	0.216	0.180	0.288	0.240
		Austenitic Stainless	0.090	0.090	0.120	0.120	0.150	0.150	0.180	0.180	0.240	0.240
		Difficult Stainless	0.090	0.090	0.120	0.120	0.150	0.150	0.180	0.180	0.240	0.240
Special Alloys	S	High Temp Alloys	0.048	0.060	0.064	0.080	0.080	0.100	0.096	0.120	0.128	0.160
		Titanium Alloys	0.072	0.060	0.096	0.080	0.120	0.100	0.144	0.120	0.192	0.160
Cast Irons	K	Grey Cast Iron	0.120	0.090	0.160	0.120	0.200	0.150	0.240	0.180	0.320	0.240
		Ductile Cast Iron	0.108	0.090	0.144	0.120	0.180	0.150	0.216	0.180	0.288	0.240
Hardened Steels	H	Hardened Steels 45 - 50HRC	0.078	0.075	0.104	0.100	0.130	0.125	0.156	0.150	0.208	0.200
Non-Ferrous	N	Aluminium Alloys	0.150	0.090	0.200	0.120	0.250	0.150	0.300	0.180	0.400	0.240
		Brass / Bronze / Copper	0.120	0.090	0.160	0.120	0.200	0.150	0.240	0.180	0.320	0.240

TuffCut® Series 5HC

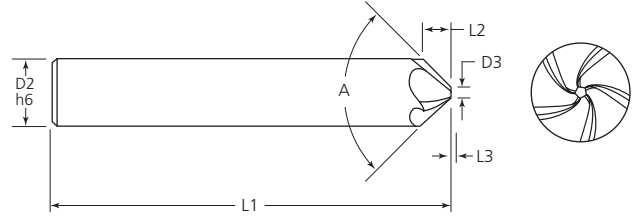
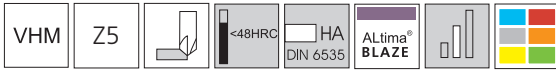

NEW
Products

Nouveaux produits
Neue Produkte
Nuovi Prodotti
Nowe Produkty

Tool Number	EDP	D2	D3	Angle	L1	L2	L3
5HCM06003B	35026	6.0	1.5	90°	57.0	2.25	0.75
5HCM08003B	35027	8.0	1.75	90°	63.0	3.125	0.875
5HCM10003B	35028	10.0	1.75	90°	72.0	4.125	0.875
5HCM12003B	35029	12.0	2.0	90°	83.0	5.0	1.0
5HCM16003B	35030	16.0	2.25	90°	92.0	6.875	1.125

TuffCut® Series 5HC

Recommended cutting data | Conditions de coupe recommandées | Empfohlene Schnittdaten | Dati di taglio Raccomandati | Zalecane Parametry

NEW Products

Nouveaux produits
Neue Produkte
Nuovi Prodotti
Nowe Produkty

Workpiece Material Group	Material Type	Coolant			Vc-m/min	Tool Diameter					
		Max	Air	MMS		6mm	8mm	10mm	12mm	16mm	
		fz-mm/tooth									
Steels	P	Low Carbon Steels	●	●	●	350	0.072	0.096	0.120	0.144	0.192
		Medium Carbon Steels	●	●	●	270	0.048	0.064	0.080	0.096	0.128
		Alloy Tool Steels	●	●	●	250	0.048	0.064	0.080	0.096	0.128
		Die/Tool Steels	●	●	●	220	0.042	0.056	0.070	0.084	0.112
Stainless Steels	M	Free Machining Stainless	●	X	○	180	0.042	0.056	0.070	0.084	0.112
		Austenitic Stainless	●	X	○	130	0.036	0.048	0.060	0.072	0.096
		Difficult Stainless	●	X	○	75	0.030	0.040	0.050	0.060	0.080
		PH Stainless	●	X	○	130	0.036	0.048	0.060	0.072	0.096
		Cobalt Chrome Alloys	●	X	○	75	0.030	0.040	0.050	0.060	0.080
		Duplex (22%)	●	X	○	75	0.030	0.040	0.050	0.060	0.080
		Super Duplex (25%)	●	X	○	55	0.030	0.040	0.050	0.060	0.080
Special Alloys	S	High Temp Alloys	●	X	X	45	0.030	0.040	0.050	0.060	0.080
		Titanium Alloys	●	X	X	100	0.036	0.048	0.060	0.072	0.096
Cast Irons	K	Grey Cast Iron	●	○	○	300	0.084	0.112	0.140	0.168	0.224
		Ductile Cast Iron	●	○	○	190	0.060	0.080	0.100	0.120	0.160
Hardened Steels	H	Hardened Steels 45 - 50HRC	○	●	○	80	0.030	0.040	0.050	0.060	0.080
		Hardened Steels 50 - 55HRC	○	●	○	60	0.036	0.048	0.060	0.072	0.096
Non Ferrous	N	Aluminium Alloys	●	X	○	600	0.072	0.096	0.120	0.144	0.192
		Brass / Bronze / Copper	●	X	○	350	0.054	0.072	0.090	0.108	0.144

● Preferred ○ Possible X Not Possible

Please note:

Technical data provided should be considered as advisory only and alterations may be necessary depending on the specific application.

Decreased feeds and/or a finish pass may be required to reach the desired surface finish requirements.

Decreased speeds and feeds may be required for heavy duty cutting.

Cutting speed (Vc) should be calculated from the effective cutting diameter using the following formula:

(Major diameter D2 + minor diameter D3) / 2.

Alternatively, estimate the actual diameter that is in contact with the workpiece.

The M.A. Ford interactive cutting data app

- Everything you need at your fingertips

Our interactive app for iOS and Android devices makes tool cutting data calculations simpler and faster by minimising text input and using 3D graphics that respond instantly to changing cutting parameters, using smart-phone or tablet touch screens.

Developed around our proven cutting data, the app supports a wide range of ISO materials including steel, aluminium alloys, stainless steel and titanium, as well as cast iron, hardened steels and exotic alloys.

Once basic information has been selected from 'drop down' menus, such as tool type, diameter and material, the app allows you to 'drag' the tool graphic display to change the radial engagement and depth of cut, which instantly calculates speeds and feeds.

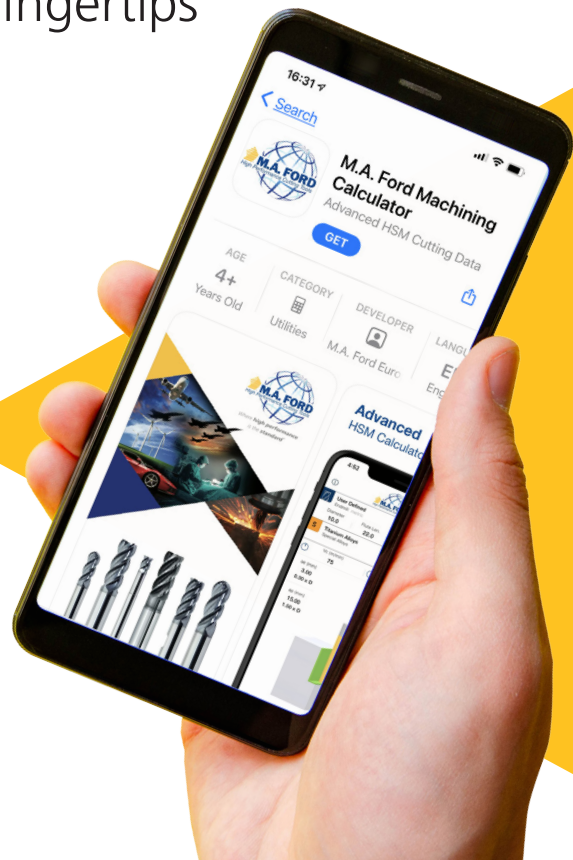

Colour coded feedback guides you toward the recommended cutting conditions based on the chosen input parameters. User over-ride controls allow cutting data to be fine-tuned for individual applications, as well as enabling calculations to be made that compare multiple scenarios instantly.

Proven cutting data can be stored via the 'Save' feature for future reference or shared with other app users. A hyperlink to M.A. Ford Europe's website also allows immediate access to online information and downloads.

Radial chip thinning data is also calculated for use with high-speed machining (HSM) strategies, which can significantly reduce cycle times and improve tool life.



For further information please contact our support team on: 01332 267960

TuffCut® XR - XT Carbide End Mills

Fraises carbure en bout · Hartmetall-Schaftfräser · Frese in Metallo Duro Integrale · Frezy palcowe pełnowęglkowe

Series	Tool Illustration	Z	Length	Ø Range (mm)	Corner Prep	Application Area	Material Group	Page
15-106		3		0.5 - 3.0	0 - 0.5			16
3MVS		3		0.5 - 3.0	0 - 0.5			16
3MVR		3		0.5 - 3.0	0 - 0.2			17
177		4		1.5 - 3.0	Sharp Corner			18
177-W		4		6.0 - 20.0	Sharp Corner			18
177R		4		3.0 - 25.0	0.25 - 6.0mm Radius			19
177RW		4		12.0 - 20.0	0.5 - 1.0mm Radius			20
177S		4		3.0 - 20.0	0.2 - 1.0mm Radius			20
177LR N5		4		6.0 - 20.0	0.3 - 3.0mm Radius			21
277N		4		3.0 - 20.0	Sharp Corner			22
277N-W		4		8.0 - 16.0	Sharp Corner			22
277NR		4		3.0 - 20.0	0.25 - 6.0mm Radius			23
277NR-W		4		8.0 - 20.0	0.5 - 6.0mm Radius			24
178		5		3.0 - 25.0	Sharp Corner			25
178-W		5		6.0 - 20.0	Sharp Corner			26
178R		5		6.0 - 25.0	0.5 - 1.0mm Radius			26
178-1		5		3.0 - 20.0	Sharp Corner			27
178-1W		5		6.0 - 20.0	Sharp Corner			27
278R N3		5		3.0 - 25.0	0.5 - 4.0mm Radius			28
278R N3-W		5		10.0 - 16.0	0.5 - 4.0mm Radius			29
278CBR N3		5		10.0 - 16.0	1.0mm Radius			30
278CBR N3-W		5		10.0 - 16.0	1.0mm Radius			30
278R N4		5		12.0 - 25.0	0.5 - 3.0mm Radius			31
278R N5		5		16.0 - 25.0	1.0 - 3.0mm Radius			31
278R N5CT		5		12.0	0.5 - 4.0mm Radius			32

TuffCut® XR - XT Carbide End Mills

Fraises carbure en bout | Hartmetall-Schaftfräser | Frese in Metallo Duro Integrale | Frezy palcowe pełnowęglkowe



Series	Tool Illustration	Z	Length	Ø Range (mm)	Corner Prep	Application Area	Matrial Group	Page
113A		6		3.0 - 20.0	Sharp Corner			32
179		4		1.5 - 16.0	N/A			33
179L N5		4		3.0 - 16.0	N/A			33
279		4		3.0 - 16.0	N/A			34
MFPB		Multi		6.0 - 20.0	N/A			35
MFTB		Multi		R2 - R8	N/A			35
MFNB		Multi		4.0 - 16.0	N/A			35
180		7		6.0 - 10.0	Sharp Corner			36
180R		7		6.0 - 20.0	0.5 - 4.0mm Radius			36
180CBR		7		10.0 - 16.0	1.0mm Radius			37
180 CBR-W		7		10.0 - 16.0	1.0mm Radius			37
180R N5		7		12.0 - 20.0	1.0 - 4.0mm Radius			38
380		9		8.0 - 20.0	0.50 - 1.00mm Radius			39
380-W		9		10.0 - 20.0	0.50 - 1.00mm Radius			39
V5LCB		5		6.0 - 16.0	0.5mm Radius			40
158		4		2.0 - 16.0	0.1 - 3.00mm Radius			42

15-106
End Mills
Fraise en bout
Schaftfräser
Frese a Candela
Frez

107-112
Routers
Fraises Diamant
Fräser
Router
Routery

113-184
Drills
Forets
Bohrer
Punte
Wierła

185-196
Reamers
Alésoirs
Reibahlen
Alesatori
Rozwiertaki

197-208
Countersinks
Fraises
Senker
Svasatori
Pogłębiacze

209-224
Burs
Fraises Limes
Frässtifte
Lime Rotative
Zadziory

TuffCut® X-AL Carbide End Mills

Fraises carbure en bout | Hartmetall-Schaftfräser | Frese in Metallo Duro Integrale | Frezy palcowe pełnowęglkowe



Series	Tool Illustration	Z	Length	Ø Range (mm)	Corner Prep	Application Area	Matrial Group	Page
135		2		3.0 - 25.0	0.2 - 0.75mm Radius			46
135 N		2		3.0 - 25.0	0.2 - 0.75mm Radius			47
135 N3		2		3.0 - 25.0	0 - 5.0mm Radius			48
135 N5		2		3.0 - 25.0	0 - 5.0mm Radius			50
135B N3		2		3.0 - 16.0	N/A			52
135B N5		2		2.0 - 16.0	N/A			52

TuffCut® X-AL Carbide End Mills

Fraises carbure en bout · Hartmetall-Schaftfräser · Frese in Metallo Duro Integrale · Frezy palcowe pełnowęglkowe

Series	Tool Illustration	Z	Length	Ø Range (mm)	Corner Prep	Application Area	Material Group	Page
15-106		3		3.0 - 20.0	0 - 6.0mm Radius			53
137V N3		3		3.0 - 20.0	0 - 6.0mm Radius			53
137V N3 AL		3		3.0 - 20.0	0 - 6.0mm Radius			53
137V N4		3		3.0 - 20.0	0 - 4.0mm Radius			55
137V N4 AL		3		3.0 - 20.0	0 - 4.0mm Radius			55
137V N5		3		3.0 - 20.0	0 - 4.0mm Radius			57
137V N5 AL		3		3.0 - 20.0	0 - 4.0mm Radius			57
138B		3		3.0 - 16.0	N/A			59
138B N5		3		2.0 - 16.0	N/A			59
137VR N3		3		12.0 - 20.0	1.0mm Radius			60
137VR N5		3		12.0 - 20.0	1.0mm Radius			60
137VF		3		3.0 - 20.0	0 - 2.0mm Radius			61
Technical Information · Informations Techniques · Technische Daten · Informazioni Tecniche · Informacje Techniczne								63-79

Carbide End Mills

Fraises carbure en bout · Hartmetall-Schaftfräser · Frese in Metallo Duro Integrale · Frezy palcowe pełnowęglkowe

Series	Tool Illustration	Z	Length	Ø Range (mm)	Application Area	Material Group	Page
164		2		0.20 - 20.0			82
164A		2		3.0 - 20.0			82
169		3		1.0 - 20.0			82
169A		3		3.0 - 20.0			82
163		4		1.0 - 20.0			82
163A		4		1.5 - 20.0			82

Carbide End Mills

Fraises carbure en bout | Hartmetall-Schafffräser | Frese in Metallo Duro Integrale | Frezy palcove pełnowęglkowe



Series	Tool Illustration	Z	Length	Ø Range (mm)	Application Area	Matrial Group	Page
166		2		1.0 - 20.0			83
166A		2		3.0 - 20.0			83
165		4		1.0 - 20.0			83
165A		4		1.0 - 20.0			83
192		3-4		8.0 - 20.0			84
121		2		0.2 - 25.0			84
121A		2		0.5 - 25.0			84
116		3		1.0 - 25.0			84
116A		3		1.0 - 25.0			84
111		4		0.2 - 25.0			84
111A		4		1.0 - 25.0			84
150		2		0.4 - 25.0			86
150A		2		1.0 - 25.0			86
140		4		1.0 - 25.0			86
140A		4		1.0 - 25.0			86
VCM60		4, 6		4.0 - 16.0	Chamfer		87
VCM60A		4, 6		4.0 - 16.0	Chamfer		87
VCM90		4, 6		4.0 - 16.0	Chamfer		87
VCM90A		4, 6		4.0 - 16.0	Chamfer		87
ACR		4		3.0 - 16.0 R0.25 - R6.0	Corner Rounding		87
MV4		4		6.0 - 20.0 R0.25 - R6.0			88



15-106
End Mills
Fraise en bout
Schafffräser
Frese a Candela
Frez



107-112
Routers
Fraises Diamant
Fräser
Router
Routery



113-184
Drills
Forets
Bohrer
Punte
Wierła



185-196
Reamers
Alésoirs
Reibahlen
Alesatori
Rozwiertaki



197-208
Countersinks
Fraises
Senker
Svasatori
Pogłębiacze



209-224
Burrs
Fraises Limes
Frässtifte
Lime Rotative
Zadziory

Carbide End Mills Anti-Vibration

· Fraises carbure en bout anti-vibrations · Hartmetall-Schaftfräser für vibrationsfreies Fräsen · Frese in Metallo Duro Integrale profilo antivibrante · Antywibracyjne frezy palcowe pełnowęglikowe

Series	Tool Illustration	Z	Length	Ø Range (mm)	Application Area	Matrial Group	Page
ASV4ACM		4		3.0 - 20.0			91
ASV 4ACM-R		4		3.0 - 20.0			92
VMH		4		3.0 - 20.0			93
VMH-W		4		3.0 - 20.0			94
V4L		4		6.0 - 20.0			94
V4LB Coated		4		6.0 - 20.0			94
ASV4ACB		4		3.0 - 20.0			95
V4LB		4		6.0 - 20.0			95
V4LB-B Coated		4		6.0 - 20.0			95

15-106

End Mills
Fraise en bout
Schaftfräser
Frese a Candela
Frez

107-112

Routers
Fraises Diamant
Fräser
Router
Routery

113-184

Drills
Forets
Bohrer
Punte
Wiertła

Carbide End Mills For Aluminium

· Fraises carbure en bout pour l'aluminium · Hartmetall-Schaftfräser für Aluminium · Frese in Metallo Duro Integrale per alluminio · Frezy pełnowęglikowe palcowe do aluminium

Series	Tool Illustration	Z	Length	Ø Range (mm)	Application Area	Matrial Group	Page
GT2		2		1.0 - 20.0			96
GT3		3		3.0 - 20.0			96
ASVSM		3		3.0 - 20.0			96
GT2R		2		2.0 - 20.0			97
GT3R		3		3.0 - 20.0			97
GT2B		2		3.0 - 20.0			98
GT3B		3		3.0 - 20.0			98
134		3		6.0 - 25.0			98

Technical Information · Informations Techniques · Technische Daten · Informazioni Tecniche · Informacje Techniczne 99-106

185-196

Reamers
Alésoirs
Reißbahnen
Alesatori
Prozwiertaki

197-208

Countersinks
Fraises
Senker
Svasatori
Pogłębiacze

209-224

Burs
Fraises Limes
Frässtifte
Lime Rotative
Zadziory

Diamond Grind Routers

Fraises diamant pour composites | Diamant-Oberfräsen | Router con taglio a diamante | Pilnik obrotowy z pokryciem diamentowym



Series	Tool Illustration	Length	Ø Range (mm)	Coating	Material Group	Page
239		38 - 100	3.0 - 12.0	Uncoated		108
239GX		38 - 100	3.0 - 12.0	GemX		108
Technical Information Informations Techniques Technische Daten Informazioni Tecniche Informacje Techniczne						109



15-106
End Mills
Fraise en bout
Schafffräser
Frese a Candela
Frez



107-112
Routers
Fraises Diamant
Fräser
Router
Routery

Diamond Grind Routers

Fraises diamant pour composites | Diamant-Oberfräsen | Router con taglio a diamante | Pilnik obrotowy z pokryciem diamentowym



Series	Tool Illustration	Length	Ø Range (mm)	Coating	Material Group	Page
230		38 - 64	0.8 - 8.0	-		111
231		38 - 64	0.8 - 8.0	-		111
231B		38 - 64	0.8 - 8.0	-		111
231D		38 - 64	0.8 - 8.0	-		111
231F		38 - 64	0.8 - 8.0	-		111
230CE		38 - 64	0.8 - 8.0	CERAEde [®]		111
231CE		38 - 64	0.8 - 8.0	CERAEde [®]		111
231BCE		38 - 64	0.8 - 8.0	CERAEde [®]		111
231DCE		38 - 64	0.8 - 8.0	CERAEde [®]		111
Technical Information Informations Techniques Technische Daten Informazioni Tecniche Informacje Techniczne						112



113-184
Drills
Forets
Bohrer
Punte
Wierła



185-196
Reamers
Alésoirs
Reibahlen
Alisatori
Rozwiertaki



197-208
Countersinks
Fraises
Senker
Svasatori
Pogłębiacze



209-224
Burrs
Fraises Limes
Frässtifte
Lime Rotative
Zadziony

High Performance Drills

Foret Haute Performance | Hochleistungsbohrer | Punte ad alte prestazioni | Wiertła wysoko wydajne

Series	Tool Illustration	Drilling Depth	Ø Range (mm)	Internal Coolant	Coating	Material Group	Page
305		Various	0.1 - 3.0	-	-		114
305AM		Various	0.3 - 3.0	-	ALtima® Micro		116
MPDCS		2 x D	1.0 - 2.95		ALtima®		117
MXDSR		5 x D	0.5 - 2.95	-	ALtima®		118
MXDCR		5 x D	1.0 - 2.95		ALtima®		119
200S		Spot Drill	3.0 - 16.0	-	ALtima®		120
CXDSS		3 x D	3.0 - 20.0	-	ALtima® Plus		120
CXDCS		3 x D	3.0 - 16.0		ALtima® Plus		120
XDSSM		3 x D	2.5 - 20.0	-	ALtima®		124
XDCSM		3 x D	3.0 - 16.0		ALtima®		124
CXDSR		5 x D	3.0 - 16.0	-	ALtima® Plus		127
CXDCR		5 x D	3.0 - 20.0		ALtima® Plus		127
XDSRM		5 x D	0.5 - 16.0	-	ALtima®		130
XDCRM		5 x D	3.0 - 20.0		ALtima®		130
XDCLM		7+ x D	3.0 - 12.0		ALtima®		133
CXDCLM		8 x D	3.0 - 16.0		ALtima® Plus		135
CXDCEM		15 x D	3.0 - 12.0		ALtima® Plus		139
MDCLM		10 x D	2.0 - 2.95		ALtima®		140
MXDCL		12 x D	1.0 - 2.95		ALtima®		141
XDCEM		12+ x D	4.0 - 12.7		ALtima®		142
CDACRM		5 x D	3.0 - 12.5		-		143
Technical Information Informations Techniques Technische Daten Informazioni Tecniche Informacje Techniczne							145-156

15-106
End Mills
Fraise en bout
Schafffräser
Frese a Candela
Frez

107-112
Routers
Fraises Diamant
Fräser
Router
Routery

113-184
Drills
Forets
Bohrer
Punte
Wiertła

185-196
Reamers
Alésoirs
Reibahlen
Alesatori
Prozwiertaki

197-208
Countersinks
Fraises
Senker
Svasatori
Pogłębiacze

209-224
Burs
Fraises Limes
Frässtifte
Lime Rotative
Zadziory

General Purpose Drills

Forets pour utilisation générale | Universalbohrer | Punte per uso generale | Wiertła ogólnego przeznaczenia

Series	Tool Illustration	Drilling Depth	Ø Range (mm)	Internal Coolant	Coating	Material Group	Page
302		Various	0.1 - 3.15	-	-		158
200		3 x D	0.8 - 20.0	-	-		159
207		5 x D	2.4 - 12.0	-	-		161
205		5 x D	0.3 - 20.0	-	-		162
300		5 x D	0.5 - 3.15	-	-		164
HPDSS		3 x D	3.0 - 16.0	-	ALtima®		165
HPDCS		3 x D	3.0 - 16.0		ALtima®		165
HPDSR		5 x D	3.0 - 16.0	-	ALtima®		168
HPDCR		5 x D	3.0 - 16.0		ALtima®		168
229		4-5 x D	2.0 - 16.0	-	-		171
224		5 x D	0.3 - 20.0	-	-		172
402		Centre Drill	0.5 - 5.0	-	-		174
404		Spot Drill 90°	5.0 - 12.0	-	-		175
403		Spot Drill 120°	5.0 - 12.0	-	-		176
PRM-KSN		8+xD	0.3 - 0.9	-	-		176
PRXS-KST		Various	1.0 - 13.0	-	TiN		177
PRXS-KMT		7+xD	1.0 - 13.0	-	TiN		178
Technical Information Informations Techniques Technische Daten Informazioni Tecniche Informacje Techniczne							180-184

Reamers

Alésoirs | Reibahlen | Alesatori | Rozwiertaki

Series	Tool Illustration	Shank Form	Tool Material	Ø Range (mm)	Coating	Tolerance	Material Group	Page
272		M.A.FORD Standard	VHM	0.33 - 16.0	-	H7		187
Technical Information Informations Techniques Technische Daten Informazioni Tecniche Informacje Techniczne								196



15-106
End Mills
Fraise en bout
Schafffräser
Frese a Candela
Frez



107-112
Routers
Fraises Diamant
Fräser
Router
Routery



113-184
Drills
Forets
Bohrer
Punte
Wiertła



185-196
Reamers
Alésoirs
Reibahlen
Alesatori
Rozwiertaki



197-208
Countersinks
Fraises
Senker
Svasatori
Pogłębiacze



209-224
Burs
Fraises Limes
Frässtifte
Lime Rotative
Zadziony

Countersinks

Fraises | Senker | Svasatori | Pogłębiacze

Series	Tool Illustration	Tool Material	Z	Included Angles	Ø Range (mm)	Type	Surface Treatment	Material Groups	Page
15-106		End Mills Fraise en bout Schafffräser Fresa a Candela Frez							
60		VHM	1	60°, 82°, 90°, 100°	3.2 - 25.4	UniFlute®	X		198
61		HSS	1	60°, 82°, 90°, 100°, 120°	3.2 - 76.2	UniFlute®	Steam Treated		198
61B		HSS	1	60°, 82°, 90°, 100°, 120°	3.2 - 25.4	UniFlute®	ALTIMA® Blaze		199
61T		HSS	1	60°, 82°, 90°, 100°, 120°	3.2 - 25.4	UniFlute®	TiN		199
92		HSS	3	60°, 82°, 90°, 100°, 120°	6.4 - 50.8	Aircraft 3 Flute	Bright Finish		204
893T		HSS	3	90°	4.3 - 31.0	3 Flute	TiN		205
78		VHM	6	60°, 82°, 90°, 100°, 120°	3.2 - 38.1	Vibration Free 6 Flute	X		201
79		HSS	6	60°, 82°, 90°, 100°, 120°	3.2 - 76.2	Vibration Free 6 Flute	Steam Treated		201
79B		HSS	6	60°, 82°, 90°, 100°, 120°	3.2 - 25.4	Vibration Free 6 Flute	ALTIMA® Blaze		202
79T		HSS	6	60°, 82°, 90°, 100°, 120°	3.2 - 25.4	Vibration Free 6 Flute	TiN		202
61 Set	UniFlute® HSS Countersink Sets - Series 61, 61T						Steam Treated		200
61T Set							TiN		200
79 Set	Vibration Free HSS Countersink Sets - Series 79, 79T						Steam Treated		203
79T Set							TiN		203
92 Set	3 Flute Aircraft HSS Countersink Sets - Series 92						Bright Finish		204
893T Set	3 Flute HSS 90° Countersink Sets - Series 893T						TiN		205
Technical Information Informations Techniques Technische Daten Informazioni Tecniche Informacje Techniczne									206-208

15-106

End Mills
Fraise en bout
Schafffräser
Fresa a Candela
Frez

107-112

Routers
Fraises Diamant
Fräser
Router
Routery

113-184

Drills
Forets
Bohrer
Punte
Wiertła

185-196

Reamers
Alésoirs
Reibahlen
Alesatori
Prozwiertaki

197-208

Countersinks
Fraises
Senker
Svasatori
Pogłębiacze

209-224

Burrs
Fraises Limes
Frässtifte
Lime Rotative
Zadziory

Carbide Burrs

Fraise Lime Rotative Carbure | Hartmetall-Frässtifte | Lime rotative in MD | Zadziozy



Series	Tool Illustration	Lengths	Ø Range (mm)	Available Shank Ø	Page
SA			Ø1.6 - Ø25.0	3.0	210
				6.0	
				8.0*	
SB			Ø3.0 - Ø25.0	3.0	211
				6.0	
				8.0*	
SC			Ø2.4 - Ø25.0	3.0	212
				6.0	
				8.0*	
SD			Ø2.4 - Ø25.0	3.0	213
				6.0	
				8.0*	
SE			Ø3.0 - Ø19.0	3.0	214
				6.0	
				8.0*	
SF			Ø3.0 - Ø19.0	3.0	215
				6.0	
				8.0*	
SG			Ø3.0 - Ø19.0	3.0	216
				6.0	
				8.0*	
SH			Ø3.0 - Ø19.0	3.0	217
				6.0	
				8.0*	
SJ			Ø3.0 - Ø25.0	3.0	218
				6.0	
				8.0*	
SK			Ø3.0 - Ø25.0	3.0	219
				6.0	
				8.0*	
SL			Ø3.0 - Ø19.0	3.0	220
				6.0	
				8.0*	
SM			Ø3.0 - Ø16.0	3.0	221
				6.0	
				8.0*	
SN			Ø2.4 - Ø19.0	3.0	222
				6.0	
				8.0*	
Technical Information Informations Techniques Technische Daten Informazioni Tecniche Informacje Techniczne					223-224

* Burrs 12.0mm and above are available with an 8.0mm shank on request as a non-stock standard.



15-106
End Mills
Fraise en bout
Schafffräser
Frese a Candela
Frez



107-112
Routers
Fraises Diamant
Fräser
Router
Routery



113-184
Drills
Forets
Bohrer
Punte
Wierla



185-196
Reamers
Aléssoirs
Reibahlen
Alesatori
Rozwiertaki



197-208
Countersinks
Fraises
Senker
Svasatori
Pogłębiacze



209-224
Burrs
Fraises Limes
Frässtifte
Lime Rotative
Zadziozy



15-106

End Mills
Fraise en bout
Schafffräser
Frese a Candela
Frez



107-112

Routers
Fraises Diamant
Fräser
Router
Routery



113-184

Drills
Forets
Bohrer
Punte
Wiertła



185-196

Reamers
Alésoirs
Reibahlen
Alesatori
Prozwiertaki



197-208

Countersinks
Fraises
Senker
Svasatori
Pogłębiacze



209-224

Burs
Fraises Limes
Frässtifte
Lime Rotative
Zadziory



Tool Material

Matière de l'outil
Werkzeugmaterial
Materiale Tagliente
Materiał Narzędzia



Number of Flutes

Nombre de Goujures
Anzahl der Schneiden
Numero di Taglienti
Ilość Ostrzy



Helix Angle

Angle d'hélice
Drallwinkel
Angolo dell'elica
Kąt linii śrubowej



Centre Cutting

Coupe au Centre
Zentrumschnitt
Taglio al Centro
Cięcie Centralne



Lengths

Longueurs
Längen
Lunghezze
Długość



Cutting Direction

Sens de Coupe
Schnittrichtung
Direzione di Taglio
Kierunek Cięcia



Profiling

Profilage
Profilerstellung
Contornatura
Profilowanie



Slotting

Rainurage
Nutfräsen
Scanalatura
Dłutowanie



3D Scanning

Numérisation 3D
3-D-Scannen
Copiaura di Profilo
Skanowanie 3D



Shank

Tiges
Schaft
Gambo
Chwył



Neck Relief

Encolure
Abgesetzter Schaft
Collo Scaricato
Zwolnienie szyjki



Material Hardness

Dureté du matériau
Materialhärte
Durezza del materiale
Twardość materiału



Coating

Revêtement
Beschichtung
Rivestimento
Powłoka



Uncoated or Coated

Sans revêtement
ou avec revêtement
Unbeschichtet
oder beschichtet
Non rivestito
o rivestito
Niepowlekane
lub powlekane



Uncoated

Sans revêtement
Unbeschichtet
Non rivestito
Niepowlekane



Solid

Solide
Fest
Solido
Lity



Coolant Feed

Liquide de refroidissement
Kühlmittelzufuhr
Con fori di lubrificazione
Chłodziwo



Drill Point Angle

Foret à angle de pointe
Spitzenwinkel der Bohrspitze
Angolo al vertice della punta
Kąt wiercenia



DIN Specs

Normes DIN
DIN-Normen
Norme DIN
Specyfikacje DIN



Lead Chamfer

Chanfrein de bec
Einführschräge
Smusso d'imbocco
Główna faza



Right Hand Cutting

Coupe à droite
Rechts schneidend
Taglio destro
Prawostronne cięcie



Included Angles

Angle inclus
Eingeschlossener Winkel
Angoli inclusi
Kąt zawarty



Thread Angle

Angle filetage
Spitzenwinkel
Angolo del profilo
Kąt gwintów



Lead

Conduire
Werkzeugmaterial
Imbocco
Nakrój



Hole Depth Type

Type de profondeur de trou
Lochtiefe
Profondità del foro
Głębokość otworu



Hole Depth Type

Type de profondeur de trou
Lochtiefe
Profondità del foro
Głębokość otworu



Wear Safety Glasses

Portez des lunettes de protection
Schutzbrille tragen
Indossare occhiali di sicurezza
Założ okulary ochronne



Wear Ear Defenders

Portez des protège-oreilles
Gehörschutz tragen
Usare le protezioni auricolari
Założ ochroniacze słuchu



Wear Protective Mask

Portez des protège-oreilles
Schutzmaske tragen
Indossare la maschera di protezione
Założ maskę ochronną



Wear Protective Gloves

Portez des gants de protection
Schutzhandschuhe tragen
Indossare I guanti di protezione
Założ ochronne rękawice



Wiper Flat

Essuie-glace Plat
Wischer Flach
Wiper Flat
Wycieraczka Płaska



Read Instructions

Lisez les instructions
Die Anleitung beachten
Leggere le istruzioni
Przeczytaj instrukcje



Technical Information

Informations techniques
Technische Daten
Informazioni tecniche
Informacje techniczne



Corner Radius

Rayon d'angle
Eckenradius
Spigolo Raggiato
Promień naroża



Ballnose

Nez boule
Kugelnase
Naso a palla
Nos kulisty



Chipbreaker

Brise-copeaux
Spanbrecher
Rompitruciolo
Łamacz wiórów



Thread Forms

Formes de fil
Faden bildet
Forme di filo
Formy wątków



Cam Radius

Rayon de came
Nockenradius
Raggio di camma
Promień krzywki



Depth of Cut

Profondeur de coupe
Schnitttiefe
Profondità di taglio
Głębokość cięcia



Tolerance Range

Plage de tolérance
Toleranzbereich
Intervallo di tolleranza
Zakres tolerancji



Profiling

Profilage
Profilierung
Profilazione
Profilowanie



X Shape

Forme en X
X-Form
Forma a X
X kształt



15-106
End Mills
Fraise en bout
Schafffräser
Frese a Candela
Frez



107-112
Routers
Fraises Diamant
Fräser
Router
Routery



113-184
Drills
Forets
Bohrer
Punte
Wierła



185-196
Reamers
Alésoirs
Reibahlen
Alesatori
Rozwiertaki



197-208
Countersinks
Fraises
Senker
Svasatori
Pogłębiacze



209-224
Burs
Fraises Limes
Frässtifte
Lime Rotative
Zadziory



Workpiece Material Group

· Groupe de matériaux des pièces · Materialgruppen der Werkstücke
 · Gruppo del materiale da lavorare · Grupa materiałów obrabianego przedmiotu



Steel

Acier
 Stahl
 Acciaio
 Stal



Cast Iron

Fontes
 Gusseisen
 Ghisa
 Żeliwo



Hardened Steels (35-65Rc)

Aciers trempés (35-65Rc)
 Gehärteter Stahl (35-65Rc)
 Acciai temprati (35-65Rc)
 Stal Hartowana (35-65Rc)



Special Alloys

Alliages spéciaux
 Speziallegierungen
 Leghe speciali
 Stopy specjalne



Stainless Steels

Aciers inoxydables
 Rostfreier Stahl
 Acciai inossidabili
 Stale nierdzewne



Non-Ferrous

Métaux non-ferreux
 Nicht eisenhaltig
 Non ferroso
 Materiał nieżelazny



15-106

End Mills
 Fraise en bout
 Schaftfräser
 Frese a Candela
 Frez



107-112

Routers
 Fraises Diamant
 Fräser
 Router
 Routery



113-184

Drills
 Forets
 Bohrer
 Punte
 Wiertła



185-196

Reamers
 Alésoirs
 Reibahlen
 Alesatori
 Rozwiertaki



197-208

Countersinks
 Fraises
 Senker
 Svasatori
 Pogłębiacze



209-224

Burrs
 Fraises Limes
 Frässtifte
 Lime Rotative
 Zadzioły



TuffCut® XR-XT

Carbide End Mills

Fraises carbure en bout | Hartmetall-Schaftfräser
Frese in Metallo Duro Integrale
Frezy palcowe pełnowęglikowe

TuffCut® XR and XT end mills form a key part of our high performance APG range and deliver outstanding results to maximise productivity, minimise process downtime and optimise cost efficiency on materials such as stainless steels, high temperature alloys and hardened steel.

(FR)

“Les fraises TuffCut® XR et XT font partie de notre gamme à haute performance APG et offrent des résultats exceptionnels afin de maximiser la productivité, de minimiser les temps d’arrêt et d’optimiser la rentabilité dans les matériaux comme les aciers inoxydables, les alliages haute température et l’acier trempé.”

(DE)

TuffCut® XR- und XT-Schaftfräser sind ein wichtiger Bestandteil unseres APG-Hochleistungssortiments. Sie liefern ausgezeichnete Ergebnisse und erhöhen so die Produktivität, verringern die Ausfallzeiten im Prozess und optimieren die Kosteneffizienz bei Material wie rostfreiem Stahl, hochtemperaturfesten Legierungen sowie gehärtetem Stahl.

(IT)

Le frese TuffCut® XR e XT sono il fulcro del nostro programma di utensili ad alte prestazioni APG e permettono di ottenere risultati eccezionali per massimizzare la produttività, ridurre al minimo il tempo di inattività dei processi e ottimizzare i costi su materiali quali acciai inossidabili, leghe ad alta temperatura ed acciaio temprato.

(PL)

Frezy TuffCut® XR i XT stanowią kluczową część naszego wysokowydajnego asortymentu APG i zapewniają znakomite rezultaty. Gwarantujemy zwiększenie wydajności, obniżenie czasu obróbki i optymalizacji kosztów w takich materiałach jak stal nierdzewna, stopy wysokotemperaturowe i stal hartowana



APG
ADVANCED PRODUCT GROUP
End Mills
Fraise en bout
Schaftfräser
Frese a Candela
Frez

	Page
TuffCut® Series 3MVS, 3MVR	16-17
TuffCut® XR Series 177, 177-W, 177R	18-19
TuffCut® XR Series 177RW, 177S, 177LR N5	20-21
TuffCut® XT Series 277N, 277N-W	22
TuffCut® XT Series 277NR	23
TuffCut® XT Series 277NR-W	24
TuffCut® XR Series 178, 178-W	25-26
TuffCut® XR Series 178R, 178-1, 178-1W	26-27
TuffCut® XT Series 278R N3, 278R N3-W	28-29
TuffCut® XT Series 278CBR N3, 278CBR N3-W	30
TuffCut® XT Series 278R N4, 278R N5	31
TuffCut® XT Series 278R N5CT	32
TuffCut® XR Series 113A	32
TuffCut® XR Series 179, 179L N5	33
TuffCut® XT Series 279	34
TuffCut® XT Series MFPB, MFTB, MFNB	35
TuffCut® XR7 Series 180, 180R, 180CBR, 180CBR-W	36-37
TuffCut® XR7 Series 180N5	38
TuffCut® XT9 Series 380, 380-W	39
TuffCut® XT Series V5LCB - CT with Central Coolant, V5LCB	40-41
TuffCut® Series 158 Corner Radius High Feed Roughing	42
TuffCut® Series 158 Corner Radius	43
Technical Information	63-74

TuffCut® Series 3MVS

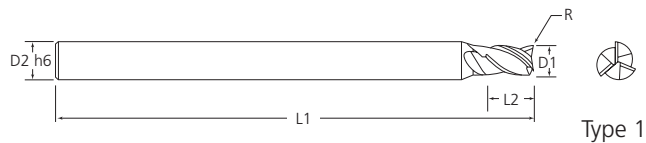
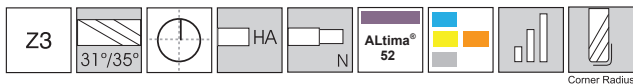

Type 1

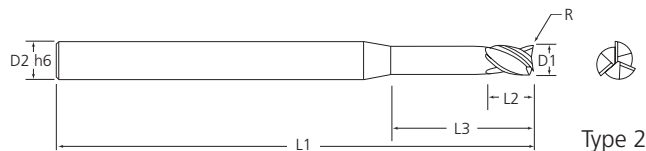

Type 2

new items

Tool Number	EDP	D1	D2	L1	L2	L3	R	Type
3MVSM0050AH	39004	0.5	4.0	50.0	0.75	-	-	1
3MVSM0050R.10AH	39070	0.5	4.0	50.0	0.75	-	0.1	1
3MVSM0050R.10N5AH	39072	0.5	4.0	50.0	0.75	2.5	0.1	2
3MVSM0050R.10N8AH	39073	0.5	4.0	50.0	0.75	4.0	0.1	2
3MVSM0100AH	39014	1.0	4.0	50.0	1.5	-	-	1
3MVSM0100N5AH	39016	1.0	4.0	50.0	1.5	5.0	-	2
3MVSM0100N8AH	39017	1.0	4.0	50.0	1.5	8.0	-	2
3MVSM0100R.10AH	39082	1.0	4.0	50.0	1.5	-	0.1	1
3MVSM0100R.10N5AH	39084	1.0	4.0	50.0	1.5	5.0	0.1	2
3MVSM0100R.10N8AH	39085	1.0	4.0	50.0	1.5	8.0	0.1	2
3MVSM0150AH	39023	1.5	4.0	50.0	2.25	-	-	1
3MVSM0150R.20AH	39094	1.5	4.0	50.0	2.25	-	0.2	1
3MVSM0150R.20N5AH	39096	1.5	4.0	50.0	2.25	7.5	0.2	2
3MVSM0150R.20N8AH	39097	1.5	4.0	50.0	2.25	12	0.2	2
3MVSM0150R.50AH	39162	1.5	4.0	50.0	2.25	-	0.5	1
3MVSM0150R.50N6AH	39163	1.5	4.0	50.0	2.25	10.0	0.5	2
3MVSM0150R.50N8AH	39164	1.5	4.0	50.0	2.25	12.0	0.5	2
3MVSM0200AH	39038	2.0	4.0	50.0	3.0	-	-	1
3MVSM0200N5AH	39040	2.0	4.0	50.0	3.0	10.0	-	2
3MVSM0200N8AH	39041	2.0	4.0	50.0	3.0	16.0	-	2
3MVSM0200R.20AH	39122	2.0	4.0	50.0	3.0	-	0.2	1
3MVSM0200R.20N5AH	39124	2.0	4.0	50.0	3.0	10.0	0.2	2
3MVSM0200R.20N8AH	39125	2.0	4.0	50.0	3.0	16.0	0.2	2
3MVSM0250AH	39050	2.5	4.0	50.0	3.75	-	-	1
3MVSM0300AH	39056	3.0	4.0	50.0	4.5	-	-	1
3MVSM0300N5AH	39058	3.0	4.0	50.0	4.5	15.0	-	2
3MVSM0300N8AH	39059	3.0	4.0	50.0	4.5	24.0	-	2
3MVSM0300R.20AH	39142	3.0	4.0	50.0	4.5	-	0.2	1
3MVSM0300R.20N5AH	39144	3.0	4.0	50.0	4.5	15.0	0.2	2
3MVSM0300R.20N8AH	39145	3.0	4.0	50.0	4.5	24.0	0.2	2



TuffCut® Series 3MVR

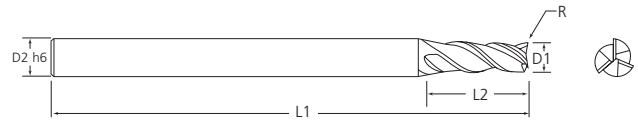

Tool Number	EDP	D1	D2	L1	L2	R
3MVRM0050AH	39005	0.5	4.0	50.0	1.5	-
3MVRM0050R.10AH	39071	0.5	4.0	50.0	1.5	0.1
3MVRM0100AH	39015	1.0	4.0	50.0	3.0	-
3MVRM0100R.10AH	39083	1.0	4.0	50.0	3.0	0.1
3MVRM0100R.20AH	36166	1.0	4.0	50.0	3.0	0.2
3MVRM0150AH	39024	1.5	4.0	50.0	4.5	-
3MVRM0150R.20AH	39095	1.5	4.0	50.0	4.5	0.2
3MVRM0200AH	39039	2.0	4.0	50.0	6.0	-
3MVRM0200R.20AH	39123	2.0	4.0	50.0	6.0	0.2
3MVRM0250AH	39051	2.5	4.0	50.0	7.5	-
3MVRM0300AH	39057	3.0	4.0	50.0	9.0	-
3MVRM0300R.20AH	39143	3.0	4.0	50.0	9.0	0.2



TuffCut® XR Series 177

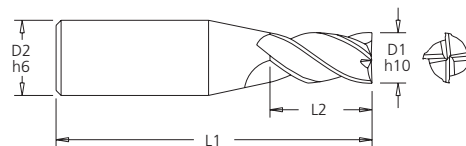
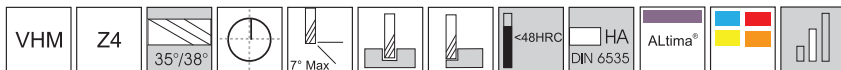

Tool No.	EDP	D1	D2	L1	L2
177 0150A	17680	1.5	3.0	38.0	3.0
177 0200A	17682	2.0	3.0	38.0	4.0
177 0250A	17684	2.5	3.0	38.0	5.0
177 0303A	17686	3.0	3.0	38.0	6.0

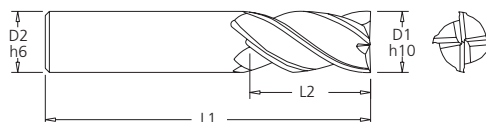

Tool No.	EDP	D1	D2	L1	L2
177 0300A	17928	3.0	6.0	57.0	8.0
177 0350A	17688	3.5	6.0	57.0	7.0
177 0400A	17930	4.0	6.0	57.0	11.0
177 0450A	17690	4.5	6.0	57.0	9.0
177 0500A	17932	5.0	6.0	57.0	13.0
177 0600A	17934	6.0	6.0	57.0	13.0
177 0800A	17937	8.0	8.0	63.0	19.0
177 1000A	17940	10.0	10.0	72.0	22.0
177 1200A	17943	12.0	12.0	83.0	26.0
177 1400A	17946	14.0	14.0	83.0	26.0
177 1600A	17950	16.0	16.0	92.0	32.0
177 1800A	17952	18.0	18.0	92.0	32.0
177 2000A	17955	20.0	20.0	104.0	38.0
177 2500A	17957	25.0	25.0	104.0	38.0



TuffCut® XR Series 177-W

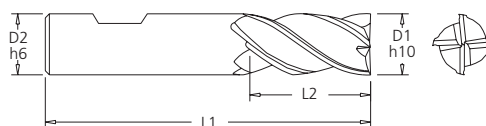
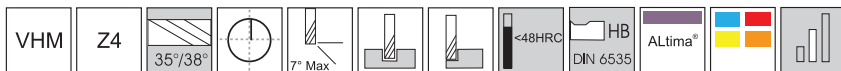

Tool No.	EDP	D1	D2	L1	L2
177 0600AW	19533	6.0	6.0	57.0	13.0
177 0800AW	18526	8.0	8.0	63.0	19.0
177 1000AW	75116	10.0	10.0	72.0	22.0
177 1200AW	75121	12.0	12.0	83.0	26.0
177 1600AW	75127	16.0	16.0	92.0	32.0
177 2000AW	75133	20.0	20.0	104.0	38.0



TuffCut® XR Series 177R

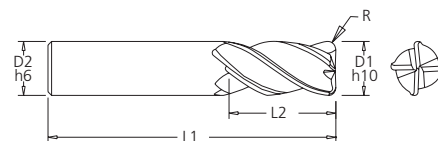
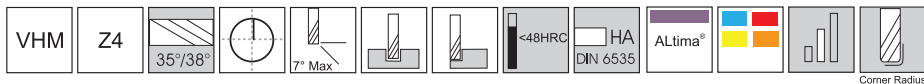

Tool No.	EDP	D1	D2	L1	L2	R
177 0300-0.25RA	17929	3.0	6.0	57.0	8.0	0.25
177 0300-0.50RA	17783	3.0	6.0	57.0	8.0	0.5
177 0400-0.25RA	17931	4.0	6.0	57.0	11.0	0.25
177 0400-0.50RA	17784	4.0	6.0	57.0	11.0	0.5
177 0500-0.25RA	17933	5.0	6.0	57.0	13.0	0.25
177 0500-0.50RA	17785	5.0	6.0	57.0	13.0	0.5
177 0600-0.25RA	17786	6.0	6.0	57.0	13.0	0.25
177 0600-0.50RA	17935	6.0	6.0	57.0	13.0	0.5
177 0600-1.0RA	17787	6.0	6.0	57.0	13.0	1.0
177 0600-1.5RA	17788	6.0	6.0	57.0	13.0	1.5
177 0600-2.0RA	18070	6.0	6.0	57.0	13.0	2.0
177 0800-0.50RA	17938	8.0	8.0	63.0	19.0	0.5
177 0800-1.0RA	17789	8.0	8.0	63.0	19.0	1.0
177 0800-1.5RA	17790	8.0	8.0	63.0	19.0	1.5
177 0800-2.0RA	17791	8.0	8.0	63.0	19.0	2.0
177 0800-3.0RA	18072	8.0	8.0	63.0	19.0	3.0
177 1000-0.50RA	17941	10.0	10.0	72.0	22.0	0.5
177 1000-1.0RA	17792	10.0	10.0	72.0	22.0	1.0
177 1000-1.5RA	17793	10.0	10.0	72.0	22.0	1.5
177 1000-2.0RA	17794	10.0	10.0	72.0	22.0	2.0
177 1000-3.0RA	96603	10.0	10.0	72.0	22.0	3.0
177 1200-0.50RA	17795	12.0	12.0	83.0	26.0	0.5
177 1200-0.75RA	17944	12.0	12.0	83.0	26.0	0.75
177 1200-1.0RA	17796	12.0	12.0	83.0	26.0	1.0
177 1200-1.5RA	17797	12.0	12.0	83.0	26.0	1.5
177 1200-2.0RA	17798	12.0	12.0	83.0	26.0	2.0
177 1200-2.5RA	18074	12.0	12.0	83.0	26.0	2.5
177 1200-3.0RA	96506	12.0	12.0	83.0	26.0	3.0
177 1200-4.0RA	18076	12.0	12.0	83.0	26.0	4.0
177 1400-0.75RA	17947	14.0	14.0	83.0	26.0	0.75
177 1600-0.50RA	18078	16.0	16.0	92.0	32.0	0.5
177 1600-1.0RA	17951	16.0	16.0	92.0	32.0	1.0
177 1600-1.5RA	17799	16.0	16.0	92.0	32.0	1.5
177 1600-2.0RA	17673	16.0	16.0	92.0	32.0	2.0
177 1600-2.5RA	18080	16.0	16.0	92.0	32.0	2.5
177 1600-3.0RA	17674	16.0	16.0	92.0	32.0	3.0
177 1600-4.0RA	18082	16.0	16.0	92.0	32.0	4.0
177 1800-1.0RA	17953	18.0	18.0	92.0	32.0	1.0
177 2000-1.0RA	17956	20.0	20.0	104.0	38.0	1.0
177 2000-1.5RA	18091	20.0	20.0	104.0	38.0	1.5
177 2000-2.0RA	18084	20.0	20.0	104.0	38.0	2.0
177 2000-3.0RA	18086	20.0	20.0	104.0	38.0	3.0
177 2000-4.0RA	18088	20.0	20.0	104.0	38.0	4.0
177 2000-5.0RA	18090	20.0	20.0	104.0	38.0	5.0
177 2000-6.0RA	18092	20.0	20.0	104.0	38.0	6.0
177 2500-1.0RA	17958	25.0	25.0	104.0	38.0	1.0



TuffCut® XR Series 177RW

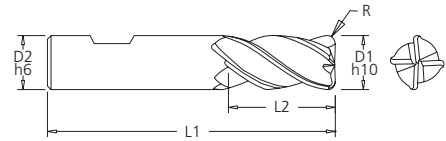
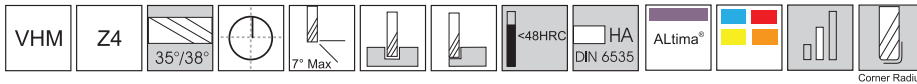

Tool No.	EDP	D1	D2	L1	L2	R
177 1200-0.50RAW	14992	12.0	12.0	83.0	26.0	0.5
177 2000-1.0RAW	75134	20.0	20.0	104.0	38.0	1.0



TuffCut® XR Series 177S

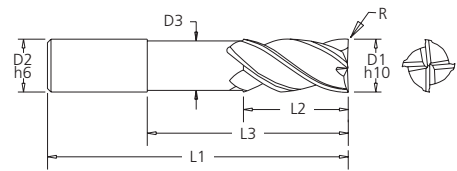
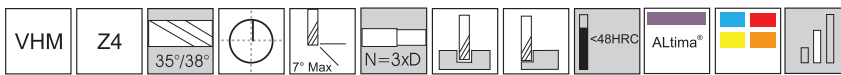

Tool No.	EDP	D1	D2	D3	L1	L2	L3	Shank
177S 0300A	18218	3.0	6.0	2.9	50.0	5.0	11.0	DIN 6535 HA
177S 0400A	18220	4.0	6.0	3.9	50.0	6.0	14.0	DIN 6535 HA
177S 0500A	18222	5.0	6.0	4.9	57.0	8.0	17.0	DIN 6535 HA
177S 0600A	18224	6.0	6.0	5.8	57.0	9.0	20.0	DIN 6535 HA
177S 0800A	18226	8.0	8.0	7.6	63.0	12.0	26.0	DIN 6535 HA
177S 1000A	18228	10.0	10.0	9.6	72.0	15.0	32.0	DIN 6535 HA
177S 1200A	18230	12.0	12.0	11.4	83.0	18.0	38.0	DIN 6535 HA
177S 1600A	18232	16.0	16.0	15.2	98.0	24.0	50.0	DIN 6535 HA
177S 2000A	18234	20.0	20.0	19.2	112.0	30.0	62.0	DIN 6535 HA



Tool No.	EDP	D1	D2	D3	L1	L2	L3	Shank
177S 0300AW	18254	3.0	6.0	2.9	50.0	5.0	11.0	DIN 6535 HB
177S 0400AW	18256	4.0	6.0	3.9	50.0	6.0	14.0	DIN 6535 HB
177S 0500AW	18258	5.0	6.0	4.9	57.0	8.0	17.0	DIN 6535 HB
177S 0600AW	18260	6.0	6.0	5.8	57.0	9.0	20.0	DIN 6535 HB
177S 0800AW	18262	8.0	8.0	7.6	63.0	12.0	26.0	DIN 6535 HB
177S 1000AW	18264	10.0	10.0	9.6	72.0	15.0	32.0	DIN 6535 HB
177S 1200AW	18266	12.0	12.0	11.4	83.0	18.0	38.0	DIN 6535 HB
177S 1600AW	18268	16.0	16.0	15.2	98.0	24.0	50.0	DIN 6535 HB
177S 2000AW	18270	20.0	20.0	19.2	112.0	30.0	62.0	DIN 6535 HB



Tool No.	EDP	D1	D2	D3	L1	L2	L3	R	Shank
177S 03-0.2RA	18200	3.0	6.0	2.9	50.0	5.0	11.0	0.2	DIN 6535 HA
177S 04-0.2RA	18202	4.0	6.0	3.9	50.0	6.0	14.0	0.2	DIN 6535 HA
177S 05-0.2RA	18204	5.0	6.0	4.9	57.0	8.0	17.0	0.2	DIN 6535 HA
177S 06-0.3RA	18206	6.0	6.0	5.8	57.0	9.0	20.0	0.3	DIN 6535 HA
177S 08-0.5RA	18208	8.0	8.0	7.6	63.0	12.0	26.0	0.5	DIN 6535 HA
177S 10-0.5RA	18210	10.0	10.0	9.6	72.0	15.0	32.0	0.5	DIN 6535 HA
177S 12-0.5RA	18212	12.0	12.0	11.4	83.0	18.0	38.0	0.5	DIN 6535 HA
177S 16-1.0RA	18214	16.0	16.0	15.2	98.0	24.0	50.0	1.0	DIN 6535 HA
177S 20-1.0RA	18216	20.0	20.0	19.2	112.0	30.0	62.0	1.0	DIN 6535 HA



TuffCut® XR Series 177S

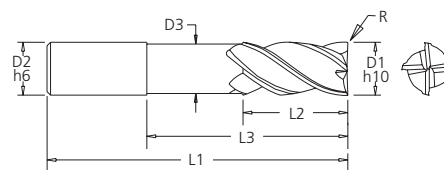

Tool No.	EDP	D1	D2	D3	L1	L2	L3	R	Shank
177S 03-0.2RAW	18236	3.0	6.0	2.9	50.0	5.0	11.0	0.2	DIN 6535 HB
177S 04-0.2RAW	18238	4.0	6.0	3.9	50.0	6.0	14.0	0.2	DIN 6535 HB
177S 05-0.2RAW	18240	5.0	6.0	4.9	57.0	8.0	17.0	0.2	DIN 6535 HB
177S 06-0.3RAW	18242	6.0	6.0	5.8	57.0	9.0	20.0	0.3	DIN 6535 HB
177S 08-0.5RAW	18244	8.0	8.0	7.6	63.0	12.0	26.0	0.5	DIN 6535 HB
177S 10-0.5RAW	18246	10.0	10.0	9.6	72.0	15.0	32.0	0.5	DIN 6535 HB
177S 12-0.5RAW	18248	12.0	12.0	11.4	83.0	18.0	38.0	0.5	DIN 6535 HB
177S 16-1.0RAW	18250	16.0	16.0	15.2	98.0	24.0	50.0	1.0	DIN 6535 HB
177S 20-1.0RAW	18252	20.0	20.0	19.2	112.0	30.0	62.0	1.0	DIN 6535 HB



DIN 6535



Corner Radius



P65

TuffCut® XR Series 177LR N5

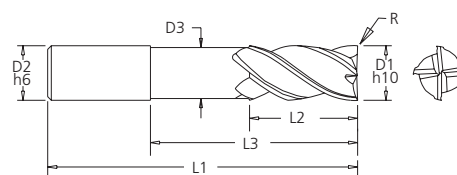
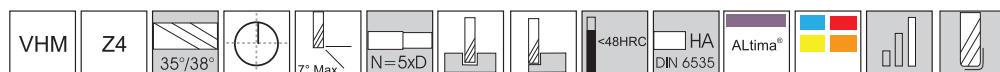

Tool No.	EDP	D1	D2	D3	L1	L2	L3	R
177L 06N5-0.25RA	18186	6.0	6.0	5.8	101.0	12.0	30.0	0.25
177L 06N5-0.5RA	18183	6.0	6.0	5.8	101.0	12.0	30.0	0.5
177L 06N5-1.0RA	18184	6.0	6.0	5.8	101.0	12.0	30.0	1.0
177L 08N5-0.5RA	18187	8.0	8.0	7.6	101.0	16.0	40.0	0.5
177L 08N5-1.0RA	18194	8.0	8.0	7.6	101.0	16.0	40.0	1.0
177L 08N5-2.0RA	18195	8.0	8.0	7.6	101.0	16.0	40.0	2.0
177L 08N5-3.0RA	18196	8.0	8.0	7.6	101.0	16.0	40.0	3.0
177L 10N5-0.5RA	18188	10.0	10.0	9.6	127.0	20.0	50.0	0.5
177L 10N5-1.0RA	18197	10.0	10.0	9.6	127.0	20.0	50.0	1.0
177L 10N5-2.0RA	18198	10.0	10.0	9.6	127.0	20.0	50.0	2.0
177L 10N5-3.0RA	18199	10.0	10.0	9.6	127.0	20.0	50.0	3.0
177L 12N5-0.5RA	18189	12.0	12.0	11.4	152.0	24.0	60.0	0.5
177L 12N5-1.0RA	18176	12.0	12.0	11.4	152.0	24.0	60.0	1.0
177L 12N5-2.0RA	18177	12.0	12.0	11.4	152.0	24.0	60.0	2.0
177L 12N5-3.0RA	18190	12.0	12.0	11.4	152.0	24.0	60.0	3.0
177L 12N5-4.0RA	18178	12.0	12.0	11.4	152.0	24.0	60.0	4.0
177L 16N5-0.5RA	18181	16.0	16.0	15.2	152.0	32.0	80.0	0.5
177L 16N5-1.0RA	18191	16.0	16.0	15.2	152.0	32.0	80.0	1.0
177L 16N5-2.0RA	18179	16.0	16.0	15.2	152.0	32.0	80.0	2.0
177L 16N5-3.0RA	18180	16.0	16.0	15.2	152.0	32.0	80.0	3.0
177L 20N5-0.5RA	18182	20.0	20.0	19.2	152.0	40.0	100.0	0.5
177L 20N5-1.0RA	18192	20.0	20.0	19.2	152.0	40.0	100.0	1.0
177L 20N5-3.0RA	18193	20.0	20.0	19.2	152.0	40.0	100.0	3.0



P65

TuffCut® XT Series 277N

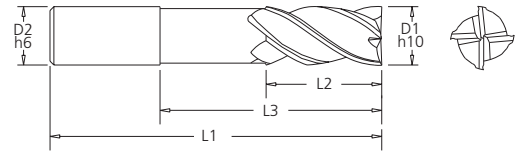
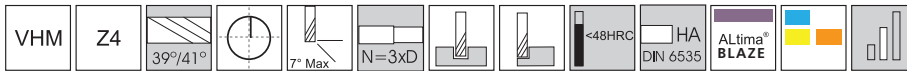

Tool No.	D1	D2	L1	L2	L3
277 03N3B	3.0	6.0	64.0	8.0	11.0
277 04N3B	4.0	6.0	64.0	11.0	14.0
277 05N3B	5.0	6.0	64.0	13.0	17.0
277 06N3B	6.0	6.0	64.0	13.0	20.0
277 08N3B	8.0	8.0	64.0	19.0	26.0
277 10N3B	10.0	10.0	73.0	22.0	32.0
277 12N3B	12.0	12.0	84.0	26.0	38.0
277 16N3B	16.0	16.0	100.0	32.0	50.0
277 20N3B	20.0	20.0	112.0	40.0	62.0



P69

TuffCut® XT Series 277N-W

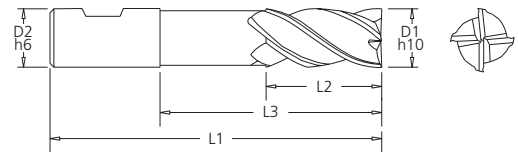
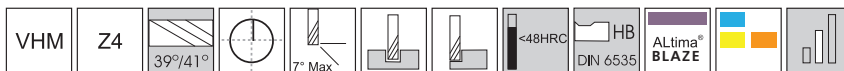

Tool No.	D1	D2	L1	L2	L3
277 08N3BW	8.0	8.0	64.0	19.0	26.0
277 10N3BW	10.0	10.0	73.0	22.0	32.0
277 12N3BW	12.0	12.0	84.0	26.0	38.0
277 16N3BW	16.0	16.0	100.0	32.0	50.0



P69

TuffCut® XT Series 277NR

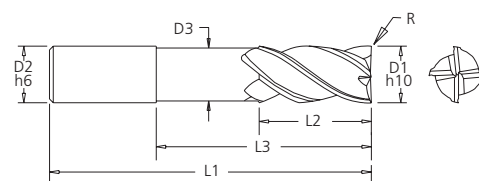
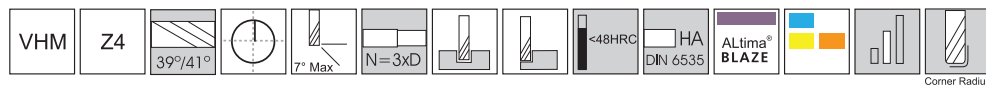

Tool No.	D1	D2	D3	L1	L2	L3	R
277 03N3-0.25RB	3.0	6.0	2.9	64.0	8.0	11.0	0.25
277 03N3-0.3RB	3.0	6.0	2.9	64.0	8.0	11.0	0.3
277 03N3-0.5RB	3.0	6.0	2.9	64.0	8.0	11.0	0.5
277 04N3-0.25RB	4.0	6.0	3.9	64.0	11.0	14.0	0.25
277 04N3-0.3RB	4.0	6.0	3.9	64.0	11.0	14.0	0.3
277 04N3-0.5RB	4.0	6.0	3.9	64.0	11.0	14.0	0.5
277 04N3-1.0RB	4.0	6.0	3.9	64.0	11.0	14.0	1.0
277 05N3-0.25RB	5.0	6.0	4.9	64.0	13.0	17.0	0.25
277 05N3-0.3RB	5.0	6.0	4.9	64.0	13.0	17.0	0.3
277 05N3-0.5RB	5.0	6.0	4.9	64.0	13.0	17.0	0.5
277 05N3-1.0RB	5.0	6.0	4.9	64.0	13.0	17.0	1.0
277 06N3-0.25RB	6.0	6.0	5.9	64.0	13.0	20.0	0.25
277 06N3-0.3RB	6.0	6.0	5.9	64.0	13.0	20.0	0.3
277 06N3-0.5RB	6.0	6.0	5.9	64.0	13.0	20.0	0.5
277 06N3-1.0RB	6.0	6.0	5.9	64.0	13.0	20.0	1.0
277 06N3-1.5RB	6.0	6.0	5.9	64.0	13.0	20.0	1.5
277 06N3-2.0RB	6.0	6.0	5.9	64.0	13.0	20.0	2.0
277 08N3-0.5RB	8.0	8.0	7.8	64.0	19.0	26.0	0.5
277 08N3-0.8RB	8.0	8.0	7.8	64.0	19.0	26.0	0.8
277 08N3-1.0RB	8.0	8.0	7.8	64.0	19.0	26.0	1.0
277 08N3-1.5RB	8.0	8.0	7.8	64.0	19.0	26.0	1.5
277 08N3-2.0RB	8.0	8.0	7.8	64.0	19.0	26.0	2.0
277 08N3-3.0RB	8.0	8.0	7.8	64.0	19.0	26.0	3.0
277 10N3-0.5RB	10.0	10.0	9.8	73.0	22.0	32.0	0.5
277 10N3-0.8RB	10.0	10.0	9.8	73.0	22.0	32.0	0.8
277 10N3-1.0RB	10.0	10.0	9.8	73.0	22.0	32.0	1.0
277 10N3-1.5RB	10.0	10.0	9.8	73.0	22.0	32.0	1.5
277 10N3-2.0RB	10.0	10.0	9.8	73.0	22.0	32.0	2.0
277 10N3-3.0RB	10.0	10.0	9.8	73.0	22.0	32.0	3.0
277 12N3-0.5RB	12.0	12.0	11.4	84.0	26.0	38.0	0.5
277 12N3-0.8RB	12.0	12.0	11.4	84.0	26.0	38.0	0.8
277 12N3-1.0RB	12.0	12.0	11.4	84.0	26.0	38.0	1.0
277 12N3-1.2RB	12.0	12.0	11.4	84.0	26.0	38.0	1.2
277 12N3-1.5RB	12.0	12.0	11.4	84.0	26.0	38.0	1.5
277 12N3-2.0RB	12.0	12.0	11.4	84.0	26.0	38.0	2.0
277 12N3-2.5RB	12.0	12.0	11.4	84.0	26.0	38.0	2.5
277 12N3-3.0RB	12.0	12.0	11.4	84.0	26.0	38.0	3.0
277 12N3-4.0RB	12.0	12.0	11.4	84.0	26.0	38.0	4.0
277 16N3-0.5RB	16.0	16.0	15.2	100.0	32.0	50.0	0.5
277 16N3-0.8RB	16.0	16.0	15.2	100.0	32.0	50.0	0.8
277 16N3-1.0RB	16.0	16.0	15.2	100.0	32.0	50.0	1.0
277 16N3-1.2RB	16.0	16.0	15.2	100.0	32.0	50.0	1.2
277 16N3-1.5RB	16.0	16.0	15.2	100.0	32.0	50.0	1.5
277 16N3-2.0RB	16.0	16.0	15.2	100.0	32.0	50.0	2.0
277 16N3-3.0RB	16.0	16.0	15.2	100.0	32.0	50.0	3.0



TuffCut® XT Series 277NR

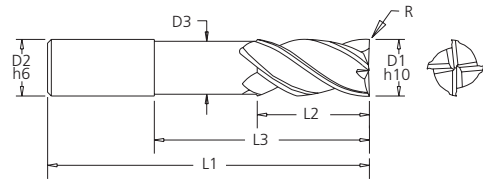
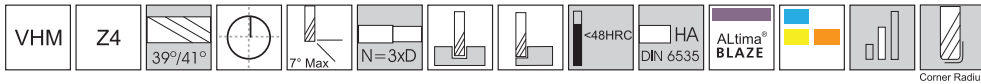

Tool No.	D1	D2	D3	L1	L2	L3	R
277 16N3-4.0RB	16.0	16.0	15.2	100.0	32.0	50.0	4.0
277 20N3-0.8RB	20.0	20.0	19.2	112.0	40.0	62.0	0.8
277 20N3-1.0RB	20.0	20.0	19.2	112.0	40.0	62.0	1.0
277 20N3-1.5RB	20.0	20.0	19.2	112.0	40.0	62.0	1.5
277 20N3-2.0RB	20.0	20.0	19.2	112.0	40.0	62.0	2.0
277 20N3-3.0RB	20.0	20.0	19.2	112.0	40.0	62.0	3.0
277 20N3-4.0RB	20.0	20.0	19.2	112.0	40.0	62.0	4.0
277 20N3-5.0RB	20.0	20.0	19.2	112.0	40.0	62.0	5.0
277 20N3-6.0RB	20.0	20.0	19.2	112.0	40.0	62.0	6.0



TuffCut® XT Series 277NR-W

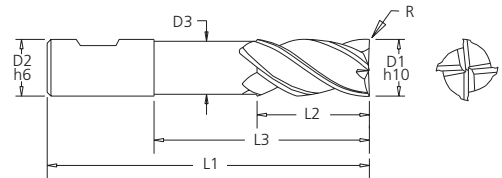
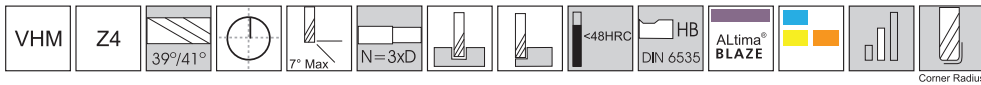

Tool No.	D1	D2	D3	L1	L2	L3	R
277 08N3-0.5RBW	8.0	8.0	7.8	64.0	19.0	26.0	0.5
277 08N3-1.0RBW	8.0	8.0	7.8	64.0	19.0	26.0	1.0
277 08N3-1.5RBW	8.0	8.0	7.8	64.0	19.0	26.0	1.5
277 08N3-2.0RBW	8.0	8.0	7.8	64.0	19.0	26.0	2.0
277 08N3-3.0RBW	8.0	8.0	7.8	64.0	19.0	26.0	3.0
277 10N3-0.5RBW	10.0	10.0	9.8	73.0	22.0	32.0	0.5
277 10N3-1.0RBW	10.0	10.0	9.8	73.0	22.0	32.0	1.0
277 10N3-1.5RBW	10.0	10.0	9.8	73.0	22.0	32.0	1.5
277 10N3-2.0RBW	10.0	10.0	9.8	73.0	22.0	32.0	2.0
277 10N3-3.0RBW	10.0	10.0	9.8	73.0	22.0	32.0	3.0
277 12N3-0.5RBW	12.0	12.0	11.4	84.0	26.0	38.0	0.5
277 12N3-1.0RBW	12.0	12.0	11.4	84.0	26.0	38.0	1.0
277 12N3-1.5RBW	12.0	12.0	11.4	84.0	26.0	38.0	1.5
277 12N3-2.0RBW	12.0	12.0	11.4	84.0	26.0	38.0	2.0
277 12N3-2.5RBW	12.0	12.0	11.4	84.0	26.0	38.0	2.5
277 12N3-3.0RBW	12.0	12.0	11.4	84.0	26.0	38.0	3.0



TuffCut® XT Series 277NR-W

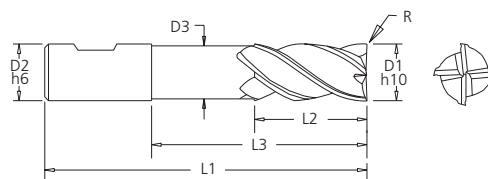
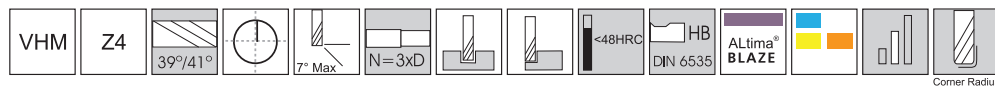

Tool No.	D1	D2	D3	L1	L2	L3	R
277 12N3-4.0RBW	12.0	12.0	11.4	84.0	26.0	38.0	4.0
277 16N3-0.5RBW	16.0	16.0	15.2	100.0	32.0	50.0	0.5
277 16N3-1.0RBW	16.0	16.0	15.2	100.0	32.0	50.0	1.0
277 16N3-1.2RBW	16.0	16.0	15.2	100.0	32.0	50.0	1.2
277 16N3-1.5RBW	16.0	16.0	15.2	100.0	32.0	50.0	1.5
277 16N3-2.0RBW	16.0	16.0	15.2	100.0	32.0	50.0	2.0
277 16N3-3.0RBW	16.0	16.0	15.2	100.0	32.0	50.0	3.0
277 16N3-4.0RBW	16.0	16.0	15.2	100.0	32.0	50.0	4.0
277 20N3-1.0RBW	20.0	20.0	19.2	112.0	40.0	62.0	1.0
277 20N3-1.5RBW	20.0	20.0	19.2	112.0	40.0	62.0	1.5
277 20N3-2.0RBW	20.0	20.0	19.2	112.0	40.0	62.0	2.0
277 20N3-3.0RBW	20.0	20.0	19.2	112.0	40.0	62.0	3.0
277 20N3-4.0RBW	20.0	20.0	19.2	112.0	40.0	62.0	4.0
277 20N3-5.0RBW	20.0	20.0	19.2	112.0	40.0	62.0	5.0
277 20N3-6.0RBW	20.0	20.0	19.2	112.0	40.0	62.0	6.0

TuffCut® XR Series 178

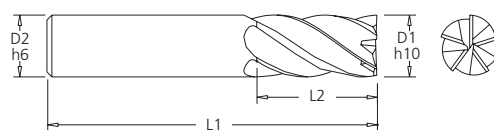
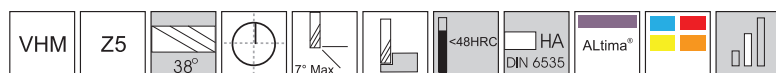

Tool No.	EDP	D1	D2	L1	L2
178 0300A	17959	3.0	6.0	57.0	8.0
178 0400A	17961	4.0	6.0	57.0	11.0
178 0500A	17963	5.0	6.0	57.0	13.0
178 0600A	17965	6.0	6.0	57.0	13.0
178 0800A	17968	8.0	8.0	63.0	19.0
178 1000A	17971	10.0	10.0	72.0	22.0
178 1200A	17974	12.0	12.0	83.0	26.0
178 1400A	17977	14.0	14.0	83.0	26.0
178 1600A	17981	16.0	16.0	92.0	32.0
178 1800A	17983	18.0	18.0	92.0	32.0
178 2000A	17986	20.0	20.0	104.0	38.0
178 2500A	17988	25.0	25.0	104.0	38.0



TuffCut® XR Series 178-W

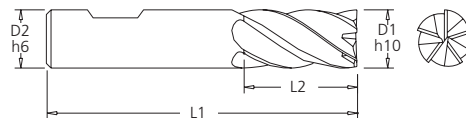
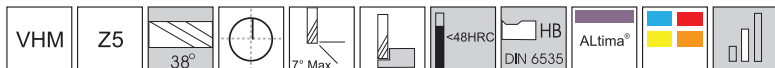

Tool No.	EDP	D1	D2	L1	L2
178 0600AW	17294	6.0	6.0	57.0	13.0
178 0800AW	14119	8.0	8.0	63.0	19.0
178 1000AW	75137	10.0	10.0	72.0	22.0
178 1200AW	19534	12.0	12.0	83.0	26.0
178 1400AW	75139	14.0	14.0	83.0	26.0
178 1600AW	75141	16.0	16.0	92.0	32.0
178 2000AW	19535	20.0	20.0	104.0	38.0



TuffCut® XR Series 178R

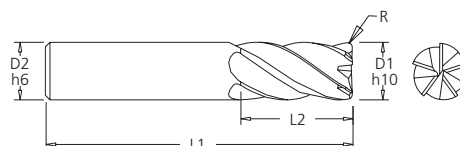
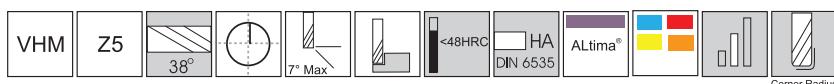

Tool No.	EDP	D1	D2	L1	L2	R
178 0600-0.50RA	17966	6.0	6.0	57.0	13.0	0.5
178 0800-0.50RA	17969	8.0	8.0	63.0	19.0	0.5
178 1000-0.50RA	17972	10.0	10.0	72.0	22.0	0.5
178 1200-0.75RA	17975	12.0	12.0	83.0	26.0	0.75
178 1400-0.75RA	17978	14.0	14.0	83.0	26.0	0.75
178 1600-1.0RA	17982	16.0	16.0	92.0	32.0	1.0
178 1800-1.0RA	17984	18.0	18.0	92.0	32.0	1.0
178 2000-1.0RA	17987	20.0	20.0	104.0	38.0	1.0
178 2500-1.0RA	17989	25.0	25.0	104.0	38.0	1.0



TuffCut® XR Series 178-1

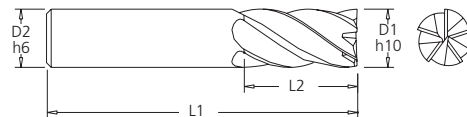
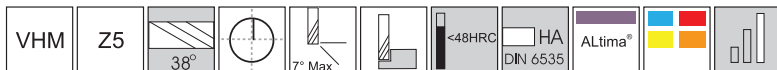

Tool No.	EDP	D1	D2	L1	L2
178 0300-1A	17998	3.0	3.0	75.0	25.0
178 0400-1A	17999	4.0	4.0	75.0	25.0
178 0500-1A	18026	5.0	5.0	75.0	25.0
178 0600-1A	18027	6.0	6.0	75.0	25.0
178 0800-1A	18028	8.0	8.0	75.0	30.0
178 1000-1A	18029	10.0	10.0	100.0	45.0
178 1200-1A	18030	12.0	12.0	150.0	75.0
178 1600-1A	18031	16.0	16.0	150.0	75.0
178 2000-1A	18032	20.0	20.0	150.0	75.0



TuffCut® XR Series 178-1W

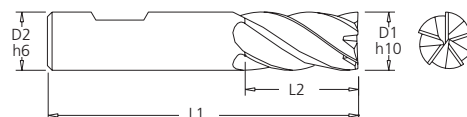
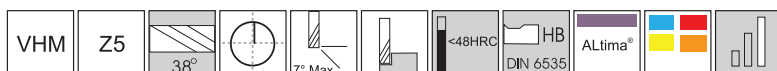

Tool No.	EDP	D1	D2	L1	L2
178 0600-1AW	17316	6.0	6.0	75.0	25.0
178 0800-1AW	17317	8.0	8.0	75.0	30.0
178 1000-1AW	16065	10.0	10.0	100.0	45.0
178 1200-1AW	19536	12.0	12.0	150.0	75.0
178 1600-1AW	19537	16.0	16.0	150.0	75.0
178 2000-1AW	15828	20.0	20.0	150.0	75.0



TuffCut® XT Series 278R N3

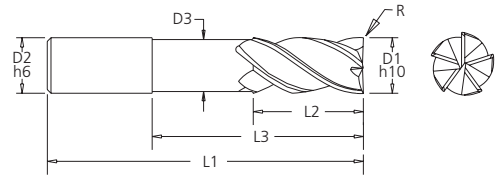
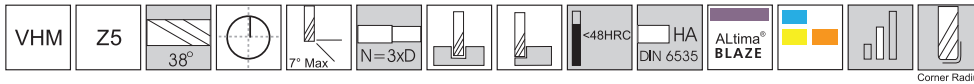

Tool No.	D1	D2	D3	L1	L2	L3	R
278 0300N3-0.25RB	3.0	6.0	2.9	57.0	8.0	10.0	0.25
278 0300N3-0.5RB	3.0	6.0	2.9	57.0	8.0	10.0	0.5
278 0400N3-0.25RB	4.0	6.0	3.9	57.0	11.0	13.0	0.25
278 0400N3-0.5RB	4.0	6.0	3.9	57.0	11.0	13.0	0.5
278 0500N3-0.25RB	5.0	6.0	4.9	57.0	13.0	16.0	0.25
278 0500N3-0.5RB	5.0	6.0	4.9	57.0	13.0	16.0	0.5
278 0600N3-0.25RB	6.0	6.0	5.9	57.0	13.0	19.0	0.25
278 0600N3-0.5RB	6.0	6.0	5.9	57.0	13.0	19.0	0.5
278 0600N3-1.0RB	6.0	6.0	5.9	57.0	13.0	19.0	1.0
278 0800N3-0.25RB	8.0	8.0	7.8	63.0	19.0	25.0	0.25
278 0800N3-0.5RB	8.0	8.0	7.8	63.0	19.0	25.0	0.5
278 0800N3-1.0RB	8.0	8.0	7.8	63.0	19.0	25.0	1.0
278 0800N3-1.5RB	8.0	8.0	7.8	63.0	19.0	25.0	1.5
278 0800N3-2.0RB	8.0	8.0	7.8	63.0	19.0	25.0	2.0
278 1000N3-0.5RB	10.0	10.0	9.8	72.0	22.0	31.0	0.5
278 1000N3-1.0RB	10.0	10.0	9.8	72.0	22.0	31.0	1.0
278 1000N3-2.0RB	10.0	10.0	9.8	72.0	22.0	31.0	2.0
278 1200N3-0.5RB	12.0	12.0	11.4	84.0	26.0	38.0	0.5
278 1200N3-1.0RB	12.0	12.0	11.4	84.0	26.0	38.0	1.0
278 1200N3-1.5RB	12.0	12.0	11.4	84.0	26.0	38.0	1.5
278 1200N3-2.0RB	12.0	12.0	11.4	84.0	26.0	38.0	2.0
278 1200N3-2.5RB	12.0	12.0	11.4	84.0	26.0	38.0	2.5
278 1200N3-3.0RB	12.0	12.0	11.4	84.0	26.0	38.0	3.0
278 1200N3-4.0RB	12.0	12.0	11.4	84.0	26.0	38.0	4.0
278 1600N3-0.5RB	16.0	16.0	15.2	100.0	35.0	50.0	0.5
278 1600N3-1.0RB	16.0	16.0	15.2	100.0	35.0	50.0	1.0
278 1600N3-1.5RB	16.0	16.0	15.2	100.0	35.0	50.0	1.5
278 1600N3-2.5RB	16.0	16.0	15.2	100.0	35.0	50.0	2.5
278 1600N3-3.0RB	16.0	16.0	15.2	100.0	35.0	50.0	3.0
278 1600N3-4.0RB	16.0	16.0	15.2	100.0	35.0	50.0	4.0
278 2000N3-1.0RB	20.0	20.0	19.2	112.0	40.0	62.0	1.0
278 2000N3-2.0RB	20.0	20.0	19.2	112.0	40.0	62.0	2.0
278 2000N3-3.0RB	20.0	20.0	19.2	112.0	40.0	62.0	3.0
278 2000N3-4.0RB	20.0	20.0	19.2	112.0	40.0	62.0	4.0
278 2500N3-1.0RB	25.0	25.0	24.6	127.0	40.0	77.0	1.0
278 2500N3-3.0RB	25.0	25.0	24.6	127.0	40.0	77.0	3.0
278 2500N3-4.0RB	25.0	25.0	24.6	127.0	40.0	77.0	4.0



TuffCut® XT Series 278R N3-W

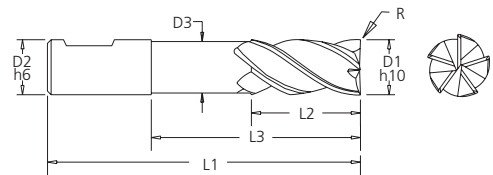
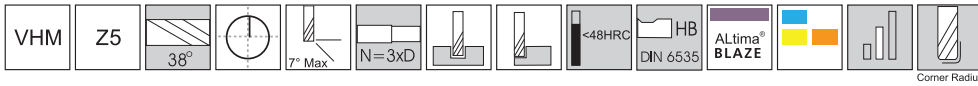

Tool No.	D1	D2	D3	L1	L2	L3	R
278 1200N3-0.5RBW	12.0	12.0	11.4	84.0	26.0	38.0	0.5
278 1200N3-1.0RBW	12.0	12.0	11.4	84.0	26.0	38.0	1.0
278 1600N3-0.5RBW	16.0	16.0	15.2	100.0	35.0	50.0	0.5
278 1600N3-1.0RBW	16.0	16.0	15.2	100.0	35.0	50.0	1.0
278 1600N3-1.5RBW	16.0	16.0	15.2	100.0	35.0	50.0	1.5
278 1600N3-3.0RBW	16.0	16.0	15.2	100.0	35.0	50.0	3.0
278 1600N3-4.0RBW	16.0	16.0	15.2	100.0	35.0	50.0	4.0



TuffCut® XT Series 278CBR N3

VHM Z5 38° 7° Max N=3xD <48HRC HA DIN 6535 ALtima® BLAZE Corner Radius CB



Close up of chipbreaker grind

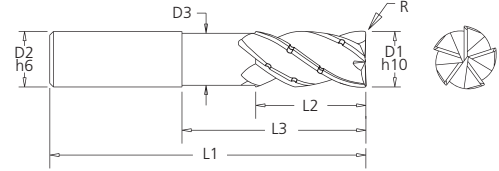

Tool No.	D1	D2	D3	L1	L2	L3	R
278CB 10N3-1.0RB	10.0	10.0	9.8	72.0	22.0	31.0	1.0
278CB 12N3-1.0RB	12.0	12.0	11.4	84.0	26.0	38.0	1.0
278CB 16N3-1.0RB	16.0	16.0	15.2	100.0	35.0	50.0	1.0



TuffCut® XT Series 278CBR N3-W

VHM Z5 38° 7° Max N=3xD <48HRC HB DIN 6535 ALtima® BLAZE Corner Radius CB



Close up of chipbreaker grind

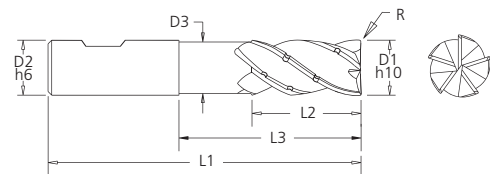

Tool No.	D1	D2	D3	L1	L2	L3	R
278CB 10N3-1.0RBW	10.0	10.0	9.8	72.0	22.0	31.0	1.0
278CB 12N3-1.0RBW	12.0	12.0	11.4	84.0	26.0	38.0	1.0
278CB 16N3-1.0RBW	16.0	16.0	15.2	100.0	35.0	50.0	1.0



TuffCut® XT Series 278R N4

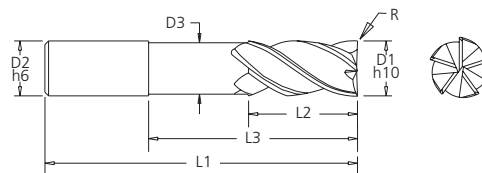
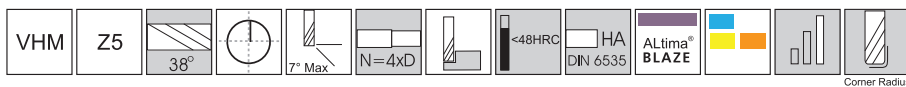

Tool No.	D1	D2	D3	L1	L2	L3	R
278 1200N4-0.5RB	12.0	12.0	11.4	100.0	18.0	50.0	0.5
278 1200N4-1.0RB	12.0	12.0	11.4	100.0	18.0	50.0	1.0
278 1200N4-1.5RB	12.0	12.0	11.4	100.0	18.0	50.0	1.5
278 1200N4-2.0RB	12.0	12.0	11.4	100.0	18.0	50.0	2.0
278 1200N4-3.0RB	12.0	12.0	11.4	100.0	18.0	50.0	3.0
278 1200N4-4.0RB	12.0	12.0	11.4	100.0	18.0	50.0	4.0
278 1600N4-1.0RB	16.0	16.0	15.2	120.0	35.0	65.0	1.0
278 1600N4-1.0RBW*	16.0	16.0	15.2	120.0	35.0	65.0	1.0
278 1600N4-3.0RB	16.0	16.0	15.2	120.0	35.0	65.0	3.0
278 2000N4-1.0RB	20.0	20.0	19.2	133.0	40.0	82.0	1.0
278 2000N4-3.0RB	20.0	20.0	19.2	133.0	40.0	82.0	3.0
278 2500N4-1.0RB	25.0	25.0	24.6	152.0	40.0	102.0	1.0
278 2500N4-3.0RB	25.0	25.0	24.6	152.0	40.0	102.0	3.0

* Indicates weldon



TuffCut® XT Series 278R N5

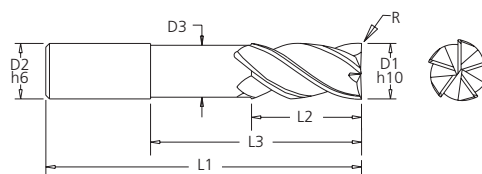
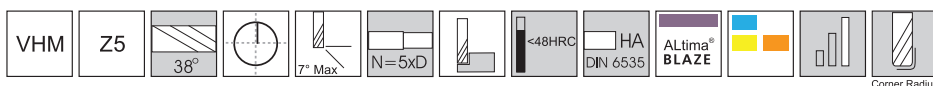

Tool No.	D1	D2	D3	L1	L2	L3	R
278 1600N5-1.0RB	16.0	16.0	15.2	133.0	35.0	82.0	1.0
278 1600N5-3.0RB	16.0	16.0	15.2	133.0	35.0	82.0	3.0
278 2000N5-1.0RB	20.0	20.0	19.2	152.0	40.0	102.0	1.0
278 2000N5-3.0RB	20.0	20.0	19.2	152.0	40.0	102.0	3.0
278 2500N5-1.0RB	25.0	25.0	24.6	180.0	40.0	125.0	1.0
278 2500N5-3.0RB	25.0	25.0	24.6	180.0	40.0	125.0	3.0



TuffCut® XT Series 278R N5CT With Central Coolant

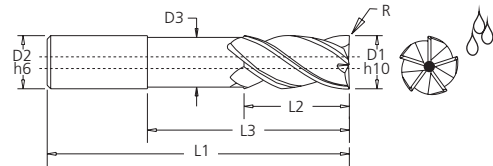
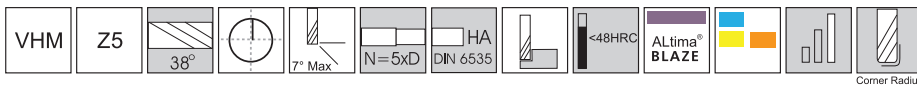

Tool No.	D1	D2	D3	L1	L2	L3	R
278 1200N5-0.5RBCT	12.0	12.0	11.4	110.0	18.0	62.0	0.5
278 1200N5-1.0RBCT	12.0	12.0	11.4	110.0	18.0	62.0	1.0
278 1200N5-1.5RBCT	12.0	12.0	11.4	110.0	18.0	62.0	1.5
278 1200N5-2.0RBCT	12.0	12.0	11.4	110.0	18.0	62.0	2.0
278 1200N5-3.0RBCT	12.0	12.0	11.4	110.0	18.0	62.0	3.0
278 1200N5-4.0RBCT	12.0	12.0	11.4	110.0	18.0	62.0	4.0



TuffCut® XR Series 113A

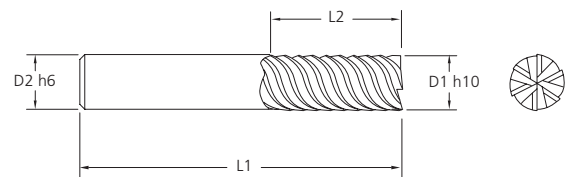
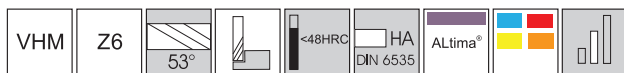

Tool No.	EDP	D1	D2	L1	L2
113 0300A	11384	3.0	3.0	38.0	12.0
113 0400A	11385	4.0	4.0	51.0	14.0
113 0500A	11386	5.0	5.0	51.0	20.0
113 0600A	11387	6.0	6.0	64.0	20.0
113 0800A	11388	8.0	8.0	64.0	20.0
113 1000A	11389	10.0	10.0	70.0	25.0
113 1200A	11390	12.0	12.0	76.0	25.0
113 1600A	11391	16.0	16.0	89.0	30.0
113 2000A	11392	20.0	20.0	102.0	38.0



TuffCut® XR Series 179

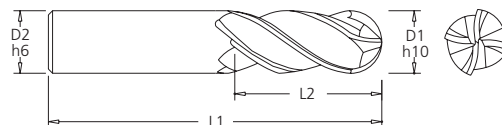
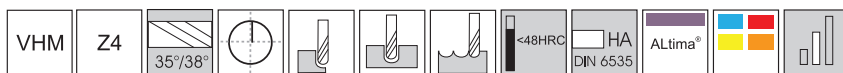

Tool No.	EDP	D1	D2	L1	L2
179 0150A	18272	1.5	3.0	38.0	3.0
179 0200A	18274	2.0	3.0	38.0	4.0
179 0250A	18276	2.5	3.0	38.0	5.0
179 0300A	18018	3.0	6.0	57.0	8.0
179 0303A	18278	3.0	3.0	38.0	6.0
179 0350A	18280	3.5	6.0	57.0	7.0
179 0400A	18019	4.0	6.0	57.0	11.0
179 0450A	18282	4.5	6.0	57.0	9.0
179 0500A	18020	5.0	6.0	57.0	13.0
179 0600A	18021	6.0	6.0	57.0	13.0
179 0800A	18022	8.0	8.0	63.0	19.0
179 1000A	18023	10.0	10.0	72.0	22.0
179 1200A	18024	12.0	12.0	83.0	26.0
179 1600A	18059	16.0	16.0	92.0	32.0



TuffCut® XR Series 179L N5

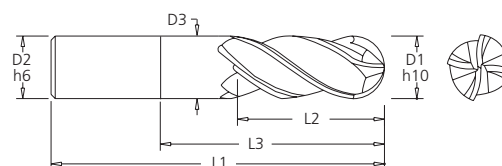
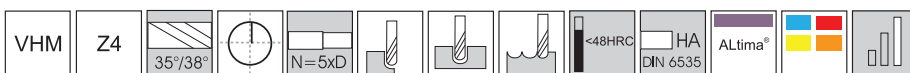

Tool No.	EDP	D1	D2	D3	L1	L2	L3
179L 03N5A	18290	3.0	6.0	2.9	75.0	4.5	17.0
179L 04N5A	18292	4.0	6.0	3.9	75.0	6.0	22.0
179L 05N5A	18294	5.0	6.0	4.9	75.0	7.5	27.0
179L 06N5A	18296	6.0	6.0	5.8	101.0	9.0	32.0
179L 08N5A	18298	8.0	8.0	7.6	101.0	12.0	42.0
179L 10N5A	18302	10.0	10.0	9.6	127.0	15.0	52.0
179L 12N5A	18304	12.0	12.0	11.4	152.0	18.0	62.0
179L 16N5A	18306	16.0	16.0	15.2	152.0	24.0	82.0



TuffCut® XT Series 279

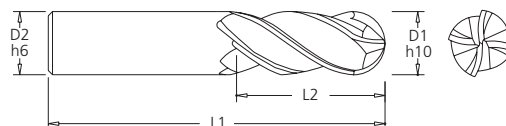
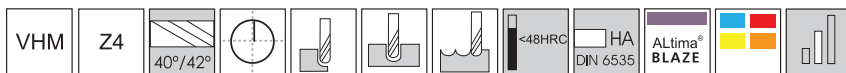

Tool Number	D1	D2	L1	L2
279 0300B	3.0	6.0	57.0	8.0
279 0400B	4.0	6.0	57.0	11.0
279 0500B	5.0	6.0	57.0	13.0
279 0600B	6.0	6.0	57.0	13.0
279 0800B	8.0	8.0	63.0	19.0
279 1000B	10.0	10.0	72.0	22.0
279 1200B	12.0	12.0	83.0	26.0
279 1600B	16.0	16.0	92.0	32.0



TuffCut® XT Series MFB

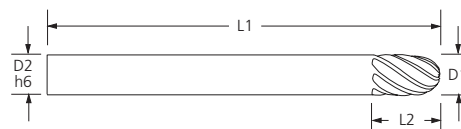

MFPB Series - Multi Flute Parallel Ballnose

Tool No.		R	D1	D2	L1	L2	L3	G°	Flutes
ALtima® Xtreme Coating	ALtima® Nano Coating								
MFPB 0601AX	MFPB 0601AN	R3	6.0	6.0	100.0	9.0	-	-	6
MFPB 0801AX	MFPB 0801AN	R4	8.0	8.0	100.0	12.0	-	-	8
MFPB 1001AX	MFPB 1001AN	R5	10.0	10.0	108.0	15.0	-	-	8
MFPB 1201AX	MFPB 1201AN	R6	12.0	12.0	108.0	18.0	-	-	8
MFPB 1601AX	MFPB 1601AN	R8	16.0	16.0	108.0	24.0	-	-	8
MFPB 2001AX	MFPB 2001AN	R10	20.0	20.0	150.0	30.0	-	-	10

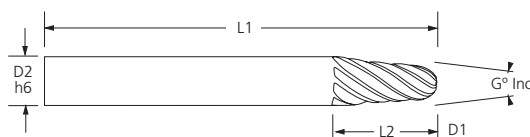

MFTB Series - Multi Flute Tapered Ballnose

Tool No.		R	D1	D2	L1	L2	L3	G°	Flutes
ALtima® Xtreme Coating	ALtima® Nano Coating								
MFTB 0402AX	MFTB 0402AN	R2	-	6.0	100.0	24.0	-	5°	6
MFTB 0502AX	MFTB 0502AN	R2.5	-	6.0	100.0	13.0	-	5°	6
MFTB 0602AX	MFTB 0602AN	R3	-	8.0	100.0	25.0	-	5°	6
MFTB 0802AX	MFTB 0802AN	R4	-	10.0	100.0	26.0	-	5°	8
MFTB 1002AX	MFTB 1002AN	R5	-	12.0	108.0	27.0	-	5°	8
MFTB 1202AX	MFTB 1202AN	R6	-	16.0	108.0	51.0	-	5°	8
MFTB 1602AX	MFTB 1602AN	R8	-	20.0	108.0	53.0	-	5°	8

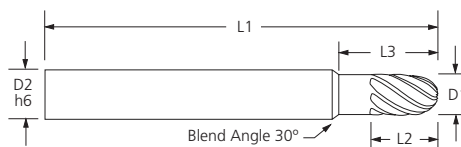

MFNB Series - Multi Flute Necked Ballnose

Tool No.		R	D1	D2	L1	L2	L3	G°	Flutes
ALtima® Xtreme Coating	ALtima® Nano Coating								
MFNB 0403AX	MFNB 0403AN	R2	4.0	6.0	100.0	6.0	8.0	-	6
MFNB 0503AX	MFNB 0503AN	R2.5	5.0	6.0	100.0	7.5	10.0	-	6
MFNB 0603AX	MFNB 0603AN	R3	6.0	8.0	100.0	9.0	12.0	-	6
MFNB 0803AX	MFNB 0803AN	R4	8.0	10.0	100.0	12.0	16.0	-	8
MFNB 1003AX	MFNB 1003AN	R5	10.0	12.0	108.0	15.0	23.0	-	8
MFNB 1203AX	MFNB 1203AN	R6	12.0	16.0	108.0	18.0	24.0	-	8
MFNB 1603AX	MFNB 1603AN	R8	16.0	20.0	108.0	24.0	32.0	-	8



TuffCut® XR7 Series 180

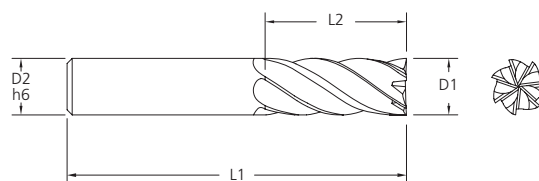
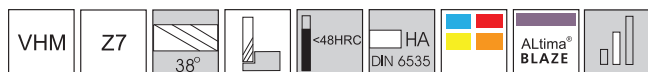

Tool Number	EDP	D1	D2	L1	L2
180 0600B	18936	6.0	6.0	57.0	13.0
180 0800B	18944	8.0	8.0	63.0	19.0
180 1000B	18940	10.0	10.0	72.0	22.0



TuffCut® XR7 Series 180R

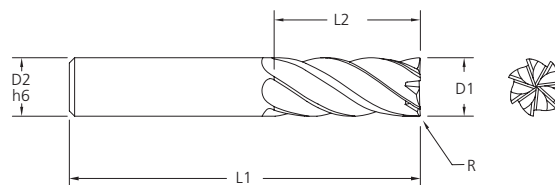
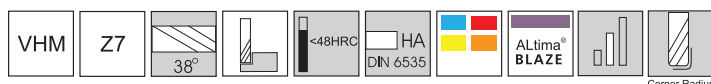

Tool Number	EDP	D1	D2	L1	L2	R
180 0600-0.5RB	18938	6.0	6.0	57.0	13.0	0.5
180 0800-0.5RB	18946	8.0	8.0	63.0	19.0	0.5
180 1000-0.5RB	18942	10.0	10.0	72.0	22.0	0.5
180 1200-0.5RB	18501	12.0	12.0	84.0	32.0	0.5
180 1200-1.0RB	18503	12.0	12.0	84.0	32.0	1.0
180 1200-2.0RB	18505	12.0	12.0	84.0	32.0	2.0
180 1200-3.0RB	18507	12.0	12.0	84.0	32.0	3.0
180 1200-4.0RB	18508	12.0	12.0	84.0	32.0	4.0
180 1600-0.5RB	18509	16.0	16.0	92.0	42.0	0.5
180 1600-1.0RB	18510	16.0	16.0	92.0	42.0	1.0
180 1600-2.0RB	18511	16.0	16.0	92.0	42.0	2.0
180 1600-3.0RB	18513	16.0	16.0	92.0	42.0	3.0
180 1600-4.0RB	18527	16.0	16.0	92.0	42.0	4.0
180 2000-0.5RB	18528	20.0	20.0	102.0	52.0	0.5
180 2000-1.0RB	18529	20.0	20.0	102.0	52.0	1.0
180 2000-2.0RB	18530	20.0	20.0	102.0	52.0	2.0
180 2000-3.0RB	18531	20.0	20.0	102.0	52.0	3.0
180 2000-4.0RB	18533	20.0	20.0	102.0	52.0	4.0



TuffCut® XR7 Series 180CBR

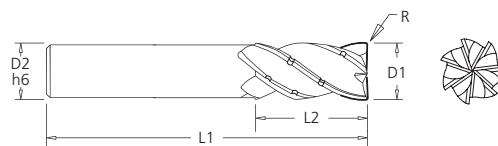
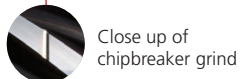
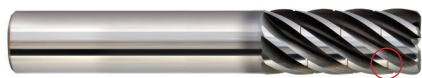

Tool Number	D1	D2	L1	L2	R
180CB 1000-1.0RB	10.0	10.0	72.0	22.0	1.0
180CB 1200-1.0RB	12.0	12.0	84.0	32.0	1.0
180CB 1600-1.0RB	16.0	16.0	92.0	42.0	1.0



TuffCut® XR7 Series 180CBR-W

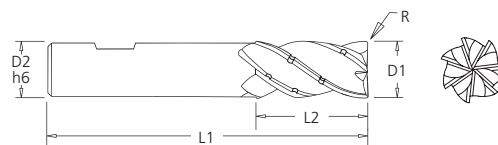
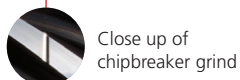
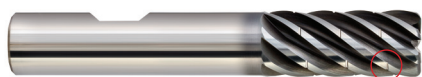

Tool Number	D1	D2	L1	L2	R
180CB 1000-1.0RBW	10.0	10.0	72.0	22.0	1.0
180CB 1200-1.0RBW	12.0	12.0	84.0	32.0	1.0
180CB 1600-1.0RBW	16.0	16.0	92.0	42.0	1.0



TuffCut® XR7 Series 180R N5

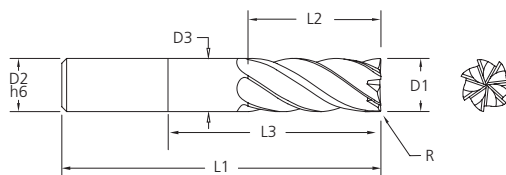
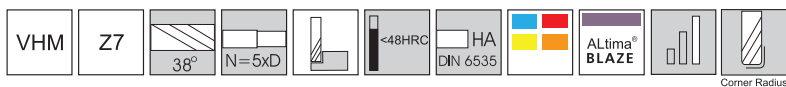

Tool No.	EDP	D1	D2	D3	L1	L2	L3	R
180 1200N5-1.0RB	18500	12.0	12.0	11.4	120.0	30.0	60.0	1.0
180 1200N5-2.0RB	18502	12.0	12.0	11.4	120.0	30.0	60.0	2.0
180 1200N5-3.0RB	18504	12.0	12.0	11.4	120.0	30.0	60.0	3.0
180 1200N5-4.0RB	18506	12.0	12.0	11.4	120.0	30.0	60.0	4.0
180 1600N5-1.0RB	18548	16.0	16.0	15.2	150.0	40.0	80.0	1.0
180 1600N5-2.0RB	18550	16.0	16.0	15.2	150.0	40.0	80.0	2.0
180 1600N5-3.0RB	18552	16.0	16.0	15.2	150.0	40.0	80.0	3.0
180 1600N5-4.0RB	18554	16.0	16.0	15.2	150.0	40.0	80.0	4.0
180 2000N5-1.0RB	18590	20.0	20.0	19.2	150.0	50.0	100.0	1.0
180 2000N5-2.0RB	18592	20.0	20.0	19.2	150.0	50.0	100.0	2.0
180 2000N5-3.0RB	18594	20.0	20.0	19.2	150.0	50.0	100.0	3.0
180 2000N5-4.0RB	18596	20.0	20.0	19.2	150.0	50.0	100.0	4.0



TuffCut® XT9 Series 380

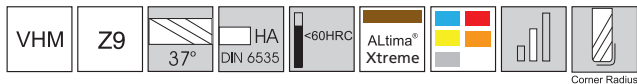

new items

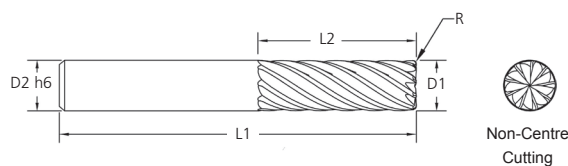

APG
ADVANCED PRODUCT GROUP
End Mills
Fraise en bout
Schafffräser
Frese a Candela
Frez

Tool Number	D1	D2	L1	L2	R
380M0800-0.5RAX	8.0	8.0	63.0	22.0	0.5
380M0800-0.8RAX	8.0	8.0	63.0	22.0	0.8
380M0800-1.0RAX	8.0	8.0	63.0	22.0	1.0
380M0800-2.0RAX	8.0	8.0	63.0	22.0	2.0
380M1000-0.5RAX	10.0	10.0	72.0	27.0	0.5
380M1000-1.0RAX	10.0	10.0	72.0	27.0	1.0
380M1000-2.0RAX	10.0	10.0	72.0	27.0	2.0
380M1200-0.5RAX	12.0	12.0	81.0	32.0	0.5
380M1200-1.0RAX	12.0	12.0	81.0	32.0	1.0
380M1200-2.0RAX	12.0	12.0	81.0	32.0	2.0
380M1200-3.0RAX	12.0	12.0	81.0	32.0	3.0
380M1600-0.5RAX	16.0	16.0	92.0	42.0	0.5
380M1600-1.0RAX	16.0	16.0	92.0	42.0	1.0
380M1600-2.0RAX	16.0	16.0	92.0	42.0	2.0
380M1600-3.0RAX	16.0	16.0	92.0	42.0	3.0
380M1600-4.0RAX	16.0	16.0	92.0	42.0	4.0
380M2000-0.5RAX	20.0	20.0	104.0	52.0	0.5
380M2000-1.0RAX	20.0	20.0	104.0	52.0	1.0



TuffCut® XT9 Series 380-W

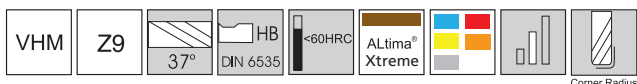

new items

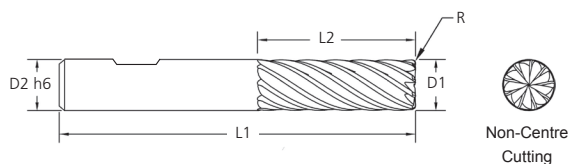

Tool Number	D1	D2	L1	L2	R
380M1000-0.5RAXW	10.0	10.0	72.0	27.0	0.5
380M1000-1.0RAXW	10.0	10.0	72.0	27.0	1.0
380M1200-0.5RAXW	12.0	12.0	81.0	32.0	0.5
380M1200-1.0RAXW	12.0	12.0	81.0	32.0	1.0
380M1600-0.5RAXW	16.0	16.0	92.0	42.0	0.5
380M1600-1.0RAXW	16.0	16.0	92.0	42.0	1.0
380M2000-0.5RAXW	20.0	20.0	104.0	52.0	0.5
380M2000-1.0RAXW	20.0	20.0	104.0	52.0	1.0



TuffCut® XT Series V5LCB - CT With Central Coolant

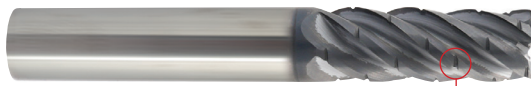
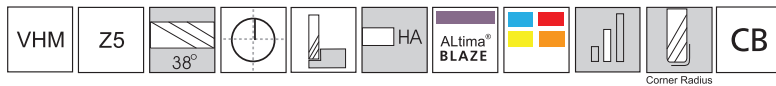

3 x D Cutting Length

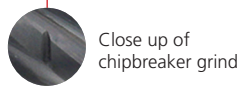

Close up of chipbreaker grind

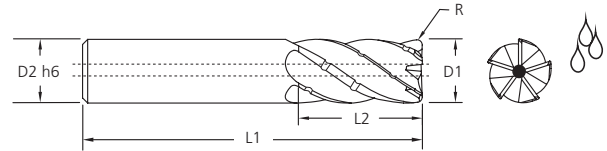

Cylindrical Shank (HA)

Tool Number	D1	D2	L1	L2	R
V5LCB 0603-0.5RB-CT	6.0	6.0	64.0	19.0	0.5
V5LCB 0803-0.5RB-CT	8.0	8.0	70.0	25.0	0.5
V5LCB 1003-0.5RB-CT	10.0	10.0	80.0	31.0	0.5
V5LCB 1203-0.5RB-CT	12.0	12.0	84.0	37.0	0.5
V5LCB 1603-0.5RB-CT	16.0	16.0	110.0	49.0	0.5



TuffCut® XT Series V5LCB - CT With Central Coolant

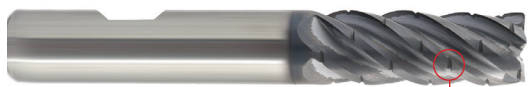
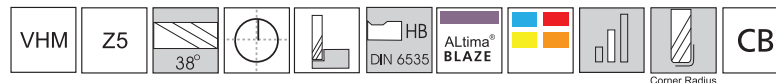

3 x D Cutting Length

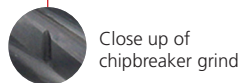

Close up of chipbreaker grind

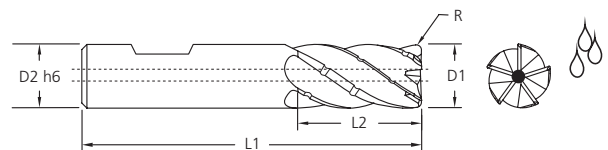

Weldon Shank (HB)

Tool Number	D1	D2	L1	L2	R
V5LCB 0803-0.5RBW-CT	8.0	8.0	70.0	25.0	0.5
V5LCB 1003-0.5RBW-CT	10.0	10.0	80.0	31.0	0.5
V5LCB 1203-0.5RBW-CT	12.0	12.0	84.0	37.0	0.5
V5LCB 1603-0.5RBW-CT	16.0	16.0	110.0	49.0	0.5



TuffCut® XT Series V5LCB

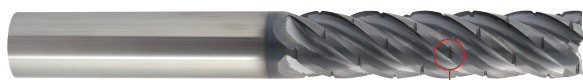
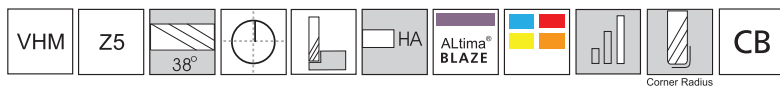

4 x D Cutting Length

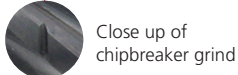

Close up of chipbreaker grind

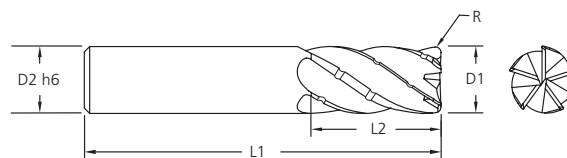

Cylindrical Shank (HA)

Tool Number	D1	D2	L1	L2	R
V5LCB 0604-0.5RB	6.0	6.0	75.0	24.0	0.5
V5LCB 0804-0.5RB	8.0	8.0	75.0	32.0	0.5
V5LCB 1004-0.5RB	10.0	10.0	90.0	40.0	0.5
V5LCB 1204-0.5RB	12.0	12.0	100.0	48.0	0.5
V5LCB 1604-0.5RB	16.0	16.0	120.0	64.0	0.5



TuffCut® XT Series V5LCB



4 x D Cutting Length

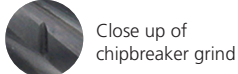

Close up of chipbreaker grind

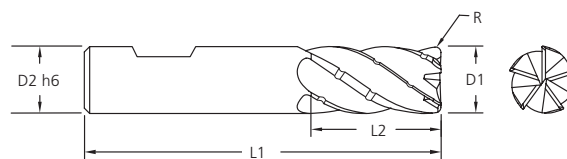

Weldon Shank (HB)

Tool Number	D1	D2	L1	L2	R
V5LCB 0804-0.5RBW	8.0	8.0	75.0	32.0	0.5
V5LCB 1004-0.5RBW	10.0	10.0	90.0	40.0	0.5
V5LCB 1204-0.5RBW	12.0	12.0	100.0	48.0	0.5
V5LCB 1604-0.5RBW	16.0	16.0	120.0	64.0	0.5



TuffCut® Series 158 Corner Radius - High Feed Roughing



Diameter	Diameter Tolerance	CR Tolerance	Shank Ø Tolerance
Ø2.0 - Ø16	+0 / - 0.02	-0.02 / +0.02	h6

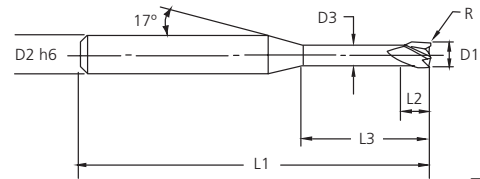

Type 1

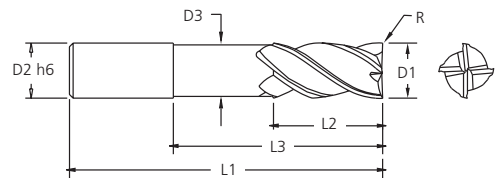

Type 2

Tool No.	D1	D2	D3	L1	L2	L3	R	Type
158 02N08-0.5RA	2.0	6.0	1.9	63.0	3.0	8.0	0.5	1
158 03N10-0.8RA	3.0	6.0	2.9	63.0	5.0	10.0	0.8	1
158 04N12-1.0RA	4.0	6.0	3.9	63.0	6.0	12.0	1.0	1
158 06N20-1.5RA	6.0	6.0	5.8	75.0	9.0	20.0	1.5	2
158 06N30-1.5RA	6.0	6.0	5.8	100.0	9.0	30.0	1.5	2
158 08N30-2.0RA	8.0	8.0	7.6	75.0	12.0	30.0	2.0	2
158 08N40-2.0RA	8.0	8.0	7.6	100.0	12.0	40.0	2.0	2
158 08N50-2.0RA	8.0	8.0	7.6	120.0	12.0	50.0	2.0	2
158 10N30-2.0RA	10.0	10.0	9.6	75.0	15.0	30.0	2.0	2
158 10N50-2.0RA	10.0	10.0	9.6	100.0	15.0	50.0	2.0	2
158 10N60-2.0RA	10.0	10.0	9.6	130.0	15.0	60.0	2.0	2
158 12N40-2.0RA	12.0	12.0	11.4	100.0	18.0	40.0	2.0	2
158 12N60-2.0RA	12.0	12.0	11.4	140.0	18.0	60.0	2.0	2
158 16N50-3.0RA	16.0	16.0	15.2	100.0	24.0	50.0	3.0	2
158 16N70-3.0RA	16.0	16.0	15.2	150.0	24.0	70.0	3.0	2



TuffCut® Series 158 Corner Radius



Diameter	Diameter Tolerance	CR Tolerance	Shank Ø Tolerance
Ø2.0 - Ø16	+0 / - 0.02	-0.02 / +0.02	h6

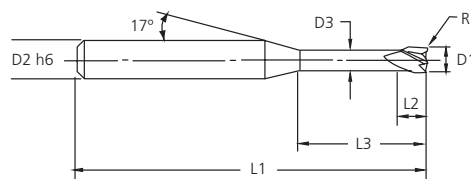

Type 1

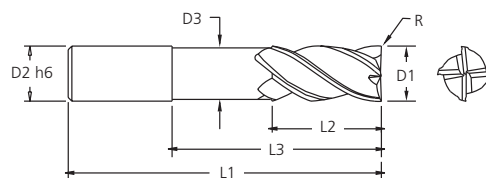

Type 2

Tool No.	D1	D2	D3	L1	L2	L3	R	Type
158 02N06-0.1RA	2.0	6.0	1.9	63.0	3.0	6.0	0.1	1
158 02N08-0.1RA	2.0	6.0	1.9	63.0	3.0	8.0	0.1	1
158 02N12-0.1RA	2.0	6.0	1.9	63.0	3.0	12.0	0.1	1
158 02N16-0.1RA	2.0	6.0	1.9	63.0	3.0	16.0	0.1	1
158 02N20-0.1RA	2.0	6.0	1.9	75.0	3.0	20.0	0.1	1
158 02N06-0.2RA	2.0	6.0	1.9	63.0	3.0	6.0	0.2	1
158 02N08-0.2RA	2.0	6.0	1.9	63.0	3.0	8.0	0.2	1
158 02N12-0.2RA	2.0	6.0	1.9	63.0	3.0	12.0	0.2	1
158 02N16-0.2RA	2.0	6.0	1.9	63.0	3.0	16.0	0.2	1
158 02N20-0.2RA	2.0	6.0	1.9	75.0	3.0	20.0	0.2	1
158 03N10-0.2RA	3.0	6.0	2.9	63.0	5.0	10.0	0.2	1
158 03N12-0.2RA	3.0	6.0	2.9	63.0	5.0	12.0	0.2	1
158 03N16-0.2RA	3.0	6.0	2.9	63.0	5.0	16.0	0.2	1
158 03N20-0.2RA	3.0	6.0	2.9	75.0	5.0	20.0	0.2	1
158 03N25-0.2RA	3.0	6.0	2.9	75.0	5.0	25.0	0.2	1
158 03N30-0.2RA	3.0	6.0	2.9	75.0	5.0	30.0	0.2	1
158 03N10-0.5RA	3.0	6.0	2.9	63.0	5.0	10.0	0.5	1
158 03N12-0.5RA	3.0	6.0	2.9	63.0	5.0	12.0	0.5	1
158 03N16-0.5RA	3.0	6.0	2.9	63.0	5.0	16.0	0.5	1
158 03N20-0.5RA	3.0	6.0	2.9	75.0	5.0	20.0	0.5	1
158 03N25-0.5RA	3.0	6.0	2.9	75.0	5.0	25.0	0.5	1
158 03N30-0.5RA	3.0	6.0	2.9	75.0	5.0	30.0	0.5	1

TuffCut® Series 158 Corner Radius

Tool No.	D1	D2	D3	L1	L2	L3	R	Type
158 04N10-0.2RA	4.0	6.0	3.9	63.0	6.0	10.0	0.2	1
158 04N12-0.2RA	4.0	6.0	3.9	63.0	6.0	12.0	0.2	1
158 04N16-0.2RA	4.0	6.0	3.9	63.0	6.0	16.0	0.2	1
158 04N20-0.2RA	4.0	6.0	3.9	75.0	6.0	20.0	0.2	1
158 04N25-0.2RA	4.0	6.0	3.9	75.0	6.0	25.0	0.2	1
158 04N30-0.2RA	4.0	6.0	3.9	75.0	6.0	30.0	0.2	1
158 04N10-0.5RA	4.0	6.0	3.9	63.0	6.0	10.0	0.5	1
158 04N12-0.5RA	4.0	6.0	3.9	63.0	6.0	12.0	0.5	1
158 04N16-0.5RA	4.0	6.0	3.9	63.0	6.0	16.0	0.5	1
158 04N20-0.5RA	4.0	6.0	3.9	75.0	6.0	20.0	0.5	1
158 04N25-0.5RA	4.0	6.0	3.9	75.0	6.0	25.0	0.5	1
158 04N30-0.5RA	4.0	6.0	3.9	75.0	6.0	30.0	0.5	1
158 06N20-0.3RA	6.0	6.0	5.8	75.0	9.0	20.0	0.3	2
158 06N20-0.5RA	6.0	6.0	5.8	75.0	9.0	20.0	0.5	2
158 06N20-1.0RA	6.0	6.0	5.8	75.0	9.0	20.0	1.0	2
158 06N30-0.3RA	6.0	6.0	5.8	100.0	9.0	30.0	0.3	2
158 06N30-0.5RA	6.0	6.0	5.8	100.0	9.0	30.0	0.5	2
158 06N30-1.0RA	6.0	6.0	5.8	100.0	9.0	30.0	1.0	2
158 08N30-0.3RA	8.0	8.0	7.6	75.0	12.0	30.0	0.3	2
158 08N30-0.5RA	8.0	8.0	7.6	75.0	12.0	30.0	0.5	2
158 08N30-1.0RA	8.0	8.0	7.6	75.0	12.0	30.0	1.0	2
158 08N40-0.3RA	8.0	8.0	7.6	100.0	12.0	40.0	0.3	2
158 08N40-0.5RA	8.0	8.0	7.6	100.0	12.0	40.0	0.5	2
158 08N40-1.0RA	8.0	8.0	7.6	100.0	12.0	40.0	1.0	2
158 08N50-0.3RA	8.0	8.0	7.6	120.0	12.0	50.0	0.3	2
158 08N50-0.5RA	8.0	8.0	7.6	120.0	12.0	50.0	0.5	2
158 08N50-1.0RA	8.0	8.0	7.6	120.0	12.0	50.0	1.0	2
158 10N30-0.3RA	10.0	10.0	9.6	75.0	15.0	30.0	0.3	2
158 10N30-0.5RA	10.0	10.0	9.6	75.0	15.0	30.0	0.5	2
158 10N30-1.0RA	10.0	10.0	9.6	75.0	15.0	30.0	1.0	2
158 10N50-0.3RA	10.0	10.0	9.6	100.0	15.0	50.0	0.3	2
158 10N50-0.5RA	10.0	10.0	9.6	100.0	15.0	50.0	0.5	2
158 10N50-1.0RA	10.0	10.0	9.6	100.0	15.0	50.0	1.0	2
158 10N60-0.3RA	10.0	10.0	9.6	130.0	15.0	60.0	0.3	2
158 10N60-0.5RA	10.0	10.0	9.6	130.0	15.0	60.0	0.5	2
158 10N60-1.0RA	10.0	10.0	9.6	130.0	15.0	60.0	1.0	2
158 12N40-0.3RA	12.0	12.0	11.4	100.0	18.0	40.0	0.3	2
158 12N40-1.0RA	12.0	12.0	11.4	100.0	18.0	40.0	1.0	2
158 12N60-0.3RA	12.0	12.0	11.4	140.0	18.0	60.0	0.3	2
158 12N60-1.0RA	12.0	12.0	11.4	140.0	18.0	60.0	1.0	2
158 16N50-0.3RA	16.0	16.0	15.2	100.0	24.0	50.0	0.3	2
158 16N50-1.0RA	16.0	16.0	15.2	100.0	24.0	50.0	1.0	2
158 16N70-0.3RA	16.0	16.0	15.2	150.0	24.0	70.0	0.3	2
158 16N70-1.0RA	16.0	16.0	15.2	150.0	24.0	70.0	1.0	2



TuffCut® X-AL

Carbide End Mills

Fraises carbure en bout ··· Hartmetall-Schaftfräser
Frese in Metallo Duro Integrale
Frezy palcowe pełnowęglikowe



APG
ADVANCED PRODUCT GROUP
End Mills
Fraise en bout
Schaftfräser
Frese a Candela
Frez

Designed to deliver exceptional metal removal rates and chip evacuation on aluminium, aluminium alloys and non-ferrous materials, the TuffCut® X-AL range has become the preferred tool choice for many precision manufacturers in a diverse range of industry sectors.

FR

“Conçue pour atteindre des niveaux exceptionnels de débit et d'évacuation copeaux dans l'aluminium, les alliages en aluminium et les métaux non-ferreux, la gamme TuffCut® X-AL est devenue l'outil de référence pour beaucoup de mécanique de précision dans divers secteurs de l'industrie.”

DE

Auf außergewöhnliche Metallabtragsleistung und Spanabfuhr bei Aluminium, Aluminiumlegierungen und eisenfreiem Material ausgelegt, das TuffCut® X-AL-Sortiment ist für viele Hersteller technischer Präzisionsteile in verschiedensten Branchen zur ersten Wahl unter den Werkzeugen geworden.

IT

La famiglia TuffCut® X-AL, progettata per offrire eccezionale capacità di asportazione ed evacuazione truciolo su alluminio, leghe di alluminio e materiali non ferrosi, è diventata la scelta ideale per molti produttori di pezzi di precisione in diversi settori industriali.

PL

Zaprojektowany tak, aby zapewnić wyjątkową szybkość usuwania materiału i odprowadzania wiórów w aluminium, stopach aluminium i materiałach nieżelaznych. Typoszereg TuffCut® X-AL stał się preferowanym wyborem narzędzi dla wielu precyzyjnych producentów w różnych gałęziach przemysłu.

	Page
TuffCut® X-AL Series 135	46
TuffCut® X-AL Series 135 N	47
TuffCut® X-AL Series 135 N3	48 - 49
TuffCut® X-AL Series 135 N5	50 - 51
TuffCut® X-AL Series 135B N3, 135B N5	52
TuffCut® X-AL Series 137V N3, 137V N3 AL	53 - 54
TuffCut® X-AL Series 137V N4, 137V N4 AL	55 - 56
TuffCut® X-AL Series 137V N5, 137V N5 AL	57 - 58
TuffCut® X-AL Series 138B, 138B N5	59
TuffCut® X-AL Series 137VR N3, 137VR N5	60
TuffCut® X-AL Series 137VF Finishing	61 - 62
Technical Information	77 - 79

TuffCut® X-AL Series 135

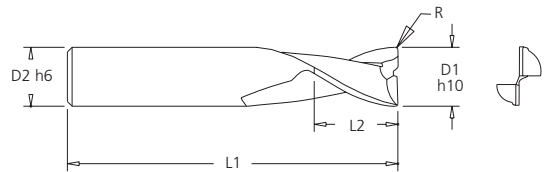
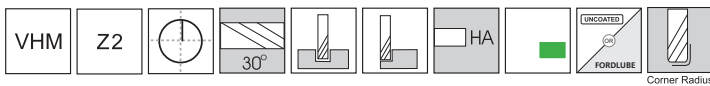

APG
ADVANCED PRODUCT GROUP
End Mills
Fraise en bout
Schafffräser
Frese a Candela
Frez

Tool Number	EDP	D1	D2	L1	L2	R
135 0300	13523	3.0	3.0	38.0	3.5	0.2
135 0400	13533	4.0	4.0	51.0	4.8	0.2
135 0500	13502	5.0	5.0	51.0	6.0	0.25
135 0600	13504	6.0	6.0	64.0	7.0	0.3
135 0800	13508	8.0	8.0	64.0	9.5	0.35
135 1000	13515	10.0	10.0	70.0	12.0	0.5
135 1200	13525	12.0	12.0	76.0	14.0	0.5
135 1400	13552	14.0	14.0	89.0	16.0	0.5
135 1600	13535	16.0	16.0	89.0	18.0	0.75
135 1800	13563	18.0	18.0	102.0	20.0	0.75
135 2000	13545	20.0	20.0	102.0	22.0	0.75
135 2500	13555	25.0	25.0	102.0	25.0	0.75



Tool Number	EDP	D1	D2	L1	L2	R
135 1001	13516	10.0	10.0	76.0	12.0	0.5
135 1201	13526	12.0	12.0	102.0	14.0	0.5
135 1401	13554	14.0	14.0	102.0	16.0	0.5
135 1601	13536	16.0	16.0	117.0	18.0	0.75
135 1801	13568	18.0	18.0	127.0	20.0	0.75
135 2001	13546	20.0	20.0	127.0	22.0	0.75
135 2501	13556	25.0	25.0	127.0	25.0	0.75



Tool Number	EDP	D1	D2	L1	L2	R
135 1002	13517	10.0	10.0	89.0	12.0	0.5
135 1202	13527	12.0	12.0	127.0	14.0	0.5
135 1402	13573	14.0	14.0	127.0	16.0	0.5
135 1602	13537	16.0	16.0	133.0	18.0	0.75
135 1802	13574	18.0	18.0	152.0	20.0	0.75
135 2002	13547	20.0	20.0	152.0	22.0	0.75
135 2502	13557	25.0	25.0	152.0	25.0	0.75



TuffCut® X-AL Series 135N

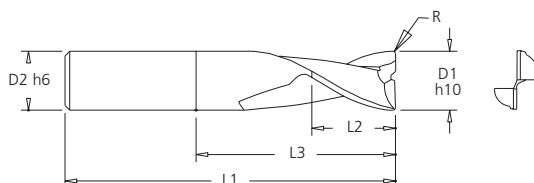
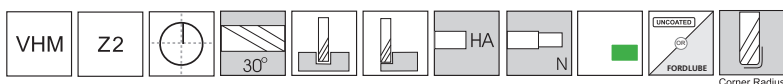

Tool Number	EDP	D1	D2	L1	L2	L3	R
135 0300N	13524	3.0	3.0	38.0	3.5	11.0	0.2
135 0400N	13534	4.0	4.0	51.0	4.8	22.0	0.2
135 0500N	13503	5.0	5.0	51.0	6.0	22.0	0.25
135 0600N	13505	6.0	6.0	64.0	7.0	26.0	0.3
135 0800N	13509	8.0	8.0	64.0	9.5	26.0	0.35
135 1000N	13565	10.0	10.0	70.0	12.0	28.0	0.5
135 1200N	13575	12.0	12.0	76.0	14.0	28.0	0.5
135 1400N	13553	14.0	14.0	89.0	16.0	42.0	0.5
135 1600N	13585	16.0	16.0	89.0	18.0	39.0	0.75
135 1800N	13564	18.0	18.0	102.0	20.0	52.0	0.75
135 2000N	13594	20.0	20.0	102.0	22.0	50.0	0.75
135 2500N	13597	25.0	25.0	102.0	25.0	36.0	0.75



Tool Number	EDP	D1	D2	L1	L2	L3	R
135 1001N	13566	10.0	10.0	76.0	12.0	34.0	0.5
135 1201N	13576	12.0	12.0	102.0	14.0	54.0	0.5
135 1401N	13558	14.0	14.0	102.0	16.0	55.0	0.5
135 1601N	13586	16.0	16.0	117.0	18.0	83.0	0.75
135 1801N	13569	18.0	18.0	127.0	20.0	77.0	0.75
135 2001N	13595	20.0	20.0	127.0	22.0	75.0	0.75
135 2501N	13598	25.0	25.0	127.0	25.0	61.0	0.75



Tool Number	EDP	D1	D2	L1	L2	L3	R
135 1002N	13567	10.0	10.0	89.0	12.0	47.0	0.5
135 1202N	13577	12.0	12.0	127.0	14.0	79.0	0.5
135 1402N	13559	14.0	14.0	127.0	16.0	80.0	0.5
135 1602N	13587	16.0	16.0	133.0	18.0	99.0	0.75
135 1802N	13578	18.0	18.0	152.0	20.0	102.0	0.75
135 2002N	13596	20.0	20.0	152.0	22.0	100.0	0.75
135 2502N	13599	25.0	25.0	152.0	25.0	86.0	0.75



TuffCut® X-AL Series 135 N3

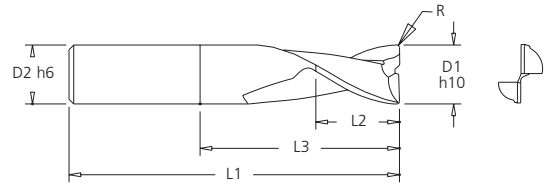
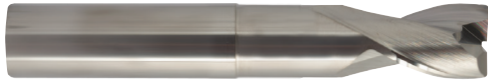
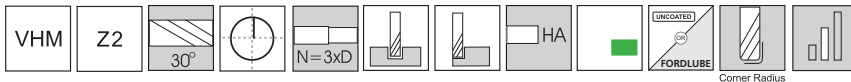

Tool Number	EDP	D1	D2	L1	L2	L3	R
135 03N3	96620	3.0	3.0	38.0	3.5	11.0	-
135 03N3-0.5R	96621	3.0	3.0	38.0	3.5	11.0	0.5
135 03N3-1.0R	96622	3.0	3.0	38.0	3.5	11.0	1.0
135 04N3	96626	4.0	4.0	51.0	4.8	14.0	-
135 04N3-0.5R	96627	4.0	4.0	51.0	4.8	14.0	0.5
135 04N3-1.0R	96628	4.0	4.0	51.0	4.8	14.0	1.0
135 05N3	96632	5.0	6.0	64.0	6.0	17.0	-
135 05N3-0.5R	96633	5.0	6.0	64.0	6.0	17.0	0.5
135 05N3-1.0R	96634	5.0	6.0	64.0	6.0	17.0	1.0
135 06N3	96638	6.0	6.0	64.0	7.0	20.0	-
135 06N3-0.5R	96639	6.0	6.0	64.0	7.0	20.0	0.5
135 06N3-1.0R	96640	6.0	6.0	64.0	7.0	20.0	1.0
135 06N3-1.5R	96641	6.0	6.0	64.0	7.0	20.0	1.5
135 06N3-2.0R	96642	6.0	6.0	64.0	7.0	20.0	2.0
135 08N3	96648	8.0	8.0	64.0	9.5	26.0	-
135 08N3-0.5R	96649	8.0	8.0	64.0	9.5	26.0	0.5
135 08N3-1.0R	96650	8.0	8.0	64.0	9.5	26.0	1.0
135 08N3-1.5R	96651	8.0	8.0	64.0	9.5	26.0	1.5
135 08N3-2.0R	96652	8.0	8.0	64.0	9.5	26.0	2.0
135 08N3-3.0R	96653	8.0	8.0	64.0	9.5	26.0	3.0
135 10N3	96660	10.0	10.0	76.0	12.0	34.0	-
135 1001N	13566	10.0	10.0	76.0	12.0	34.0	0.5
135 10N3-1.0R	96662	10.0	10.0	76.0	12.0	34.0	1.0
135 10N3-1.5R	96663	10.0	10.0	76.0	12.0	34.0	1.5
135 10N3-2.0R	96664	10.0	10.0	76.0	12.0	34.0	2.0
135 10N3-3.0R	96665	10.0	10.0	76.0	12.0	34.0	3.0
135 12N3	96671	12.0	12.0	76.0	14.0	38.0	-



TuffCut® X-AL Series 135 N3

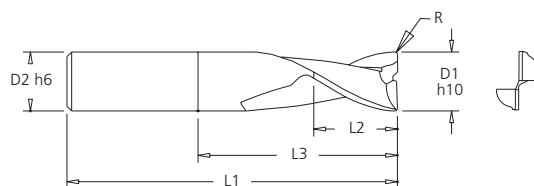
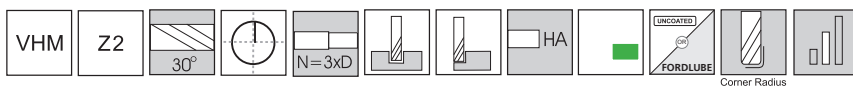

Tool Number	EDP	D1	D2	L1	L2	L3	R
135 12N3-0.5R	96672	12.0	12.0	76.0	14.0	38.0	0.5
135 12N3-1.0R	96673	12.0	12.0	76.0	14.0	38.0	1.0
135 12N3-1.5R	96674	12.0	12.0	76.0	14.0	38.0	1.5
135 12N3-2.0R	96675	12.0	12.0	76.0	14.0	38.0	2.0
135 12N3-3.0R	96676	12.0	12.0	76.0	14.0	38.0	3.0
135 12N3-4.0R	96677	12.0	12.0	76.0	14.0	38.0	4.0
135 16N3	96684	16.0	16.0	117.0	18.0	53.0	-
135 16N3-0.5R	96685	16.0	16.0	117.0	18.0	53.0	0.5
135 16N3-1.0R	96686	16.0	16.0	117.0	18.0	53.0	1.0
135 16N3-1.5R	96687	16.0	16.0	117.0	18.0	53.0	1.5
135 16N3-2.0R	96688	16.0	16.0	117.0	18.0	53.0	2.0
135 16N3-3.0R	96689	16.0	16.0	117.0	18.0	53.0	3.0
135 16N3-4.0R	96690	16.0	16.0	117.0	18.0	53.0	4.0
135 20N3-0.5R	96697	20.0	20.0	127.0	22.0	65.0	0.5
135 20N3-1.0R	96698	20.0	20.0	127.0	22.0	65.0	1.0
135 20N3-1.5R	96699	20.0	20.0	127.0	22.0	65.0	1.5
135 20N3-2.0R	96700	20.0	20.0	127.0	22.0	65.0	2.0
135 20N3-3.0R	96701	20.0	20.0	127.0	22.0	65.0	3.0
135 20N3-4.0R	96702	20.0	20.0	127.0	22.0	65.0	4.0
135 20N3-5.0R	96722	20.0	20.0	127.0	22.0	65.0	5.0
135 25N3-0.5R	96709	25.0	25.0	127.0	25.0	80.0	0.5
135 25N3-1.0R	96710	25.0	25.0	127.0	25.0	80.0	1.0
135 25N3-1.5R	96711	25.0	25.0	127.0	25.0	80.0	1.5
135 25N3-2.0R	96712	25.0	25.0	127.0	25.0	80.0	2.0
135 25N3-3.0R	96713	25.0	25.0	127.0	25.0	80.0	3.0
135 25N3-4.0R	96714	25.0	25.0	127.0	25.0	80.0	4.0



TuffCut® X-AL Series 135 N5

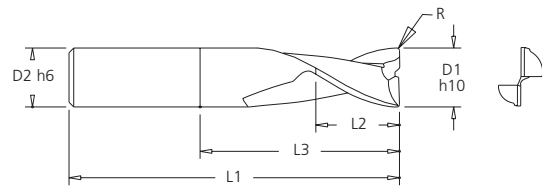
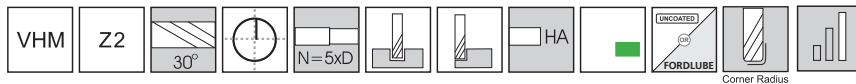

Tool Number	EDP	D1	D2	L1	L2	L3	R
135 03N5	96623	3.0	3.0	38.0	3.5	16.0	-
135 03N5-0.5R	96624	3.0	3.0	38.0	3.5	16.0	0.5
135 03N5-1.0R	96625	3.0	3.0	38.0	3.5	16.0	1.0
135 04N5	96629	4.0	4.0	51.0	4.8	22.0	-
135 04N5-0.5R	96630	4.0	4.0	51.0	4.8	22.0	0.5
135 04N5-1.0R	96631	4.0	4.0	51.0	4.8	22.0	1.0
135 05N5	96635	5.0	6.0	64.0	6.0	27.0	-
135 05N5-0.5R	96636	5.0	6.0	64.0	6.0	27.0	0.5
135 05N5-1.0R	96637	5.0	6.0	64.0	6.0	27.0	1.0
135 06N5	96643	6.0	6.0	64.0	7.0	32.0	-
135 06N5-0.5R	96644	6.0	6.0	64.0	7.0	32.0	0.5
135 06N5-1.0R	96645	6.0	6.0	64.0	7.0	32.0	1.0
135 06N5-1.5R	96646	6.0	6.0	64.0	7.0	32.0	1.5
135 06N5-2.0R	96647	6.0	6.0	64.0	7.0	32.0	2.0
135 08N5	96654	8.0	8.0	75.0	9.5	42.0	-
135 08N5-0.5R	96655	8.0	8.0	75.0	9.5	42.0	0.5
135 08N5-1.0R	96656	8.0	8.0	75.0	9.5	42.0	1.0
135 08N5-1.5R	96657	8.0	8.0	75.0	9.5	42.0	1.5
135 08N5-2.0R	96658	8.0	8.0	75.0	9.5	42.0	2.0
135 08N5-3.0R	96659	8.0	8.0	75.0	9.5	42.0	3.0
135 10N5-0.5R	96666	10.0	10.0	89.0	12.0	52.0	0.5
135 10N5-1.0R	96667	10.0	10.0	89.0	12.0	52.0	1.0
135 10N5-1.5R	96668	10.0	10.0	89.0	12.0	52.0	1.5
135 10N5-2.0R	96669	10.0	10.0	89.0	12.0	52.0	2.0
135 10N5-3.0R	96670	10.0	10.0	89.0	12.0	52.0	3.0
135 12N5-0.5R	96678	12.0	12.0	110.0	14.0	62.0	0.5



TuffCut® X-AL Series 135 N5

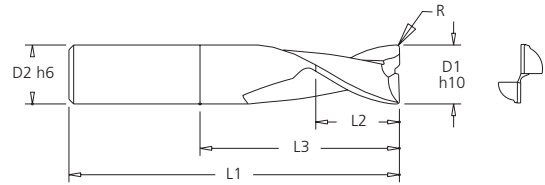
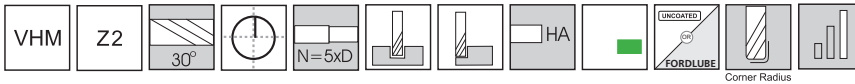

Tool Number	EDP	D1	D2	L1	L2	L3	R
135 12N5-1.0R	96679	12.0	12.0	110.0	14.0	62.0	1.0
135 12N5-1.5R	96680	12.0	12.0	110.0	14.0	62.0	1.5
135 12N5-2.0R	96681	12.0	12.0	110.0	14.0	62.0	2.0
135 12N5-3.0R	96682	12.0	12.0	110.0	14.0	62.0	3.0
135 12N5-4.0R	96683	12.0	12.0	110.0	14.0	62.0	4.0
135 12N5-5.0R	96723	12.0	12.0	110.0	14.0	62.0	5.0
135 16N5-0.5R	96691	16.0	16.0	127.0	18.0	85.0	0.5
135 16N5-1.0R	96692	16.0	16.0	127.0	18.0	85.0	1.0
135 16N5-1.5R	96693	16.0	16.0	127.0	18.0	85.0	1.5
135 16N5-2.0R	96694	16.0	16.0	127.0	18.0	85.0	2.0
135 16N5-3.0R	96695	16.0	16.0	127.0	18.0	85.0	3.0
135 16N5-4.0R	96696	16.0	16.0	127.0	18.0	85.0	4.0
135 20N5-0.5R	96703	20.0	20.0	152.0	22.0	105.0	0.5
135 20N5-1.0R	96704	20.0	20.0	152.0	22.0	105.0	1.0
135 20N5-1.5R	96705	20.0	20.0	152.0	22.0	105.0	1.5
135 20N5-2.0R	96706	20.0	20.0	152.0	22.0	105.0	2.0
135 20N5-3.0R	96707	20.0	20.0	152.0	22.0	105.0	3.0
135 20N5-4.0R	96708	20.0	20.0	152.0	22.0	105.0	4.0
135 20N5-5.0R	96724	20.0	20.0	152.0	22.0	105.0	5.0
135 25N5-0.5R	96715	25.0	25.0	180.0	25.0	130.0	0.5
135 25N5-1.0R	96716	25.0	25.0	180.0	25.0	130.0	1.0
135 25N5-1.5R	96717	25.0	25.0	180.0	25.0	130.0	1.5
135 25N5-2.0R	96718	25.0	25.0	180.0	25.0	130.0	2.0
135 25N5-3.0R	96719	25.0	25.0	180.0	25.0	130.0	3.0
135 25N5-4.0R	96720	25.0	25.0	180.0	25.0	130.0	4.0



TuffCut® X-AL Series 135B N3

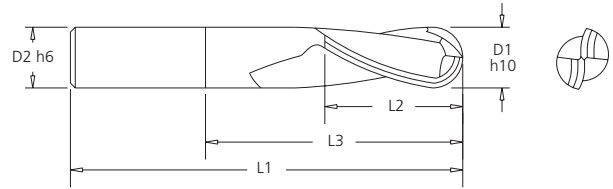
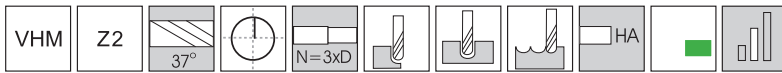

Tool Number	EDP	D1	D2	L1	L2	L3
135B 0300N3	13236	3.0	3.0	38.0	5.0	11.0
135B 0400N3	13238	4.0	4.0	51.0	6.0	14.0
135B 0500N3	13240	5.0	5.0	64.0	7.0	17.0
135B 0600N3	13242	6.0	6.0	64.0	8.0	20.0
135B 0800N3	13244	8.0	8.0	64.0	10.0	26.0
135B 1000N3	13246	10.0	10.0	70.0	12.0	32.0
135B 1200N3	13248	12.0	12.0	76.0	16.0	38.0
135B 1600N3	13250	16.0	16.0	89.0	20.0	50.0



TuffCut® X-AL Series 135B N5

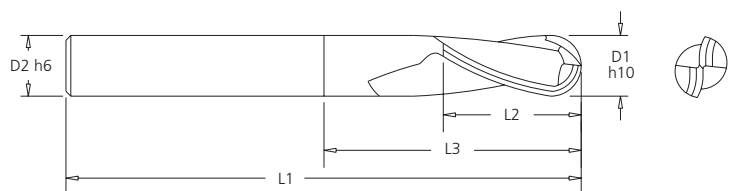
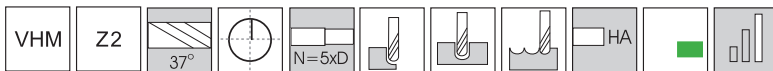

Tool Number	EDP	D1	D2	L1	L2	L3
135B 0200N5	13252	2.0	6.0	75.0	4.0	12.0
135B 0300N5	13254	3.0	6.0	75.0	5.0	17.0
135B 0400N5	13256	4.0	6.0	75.0	6.0	22.0
135B 0500N5	13258	5.0	6.0	75.0	7.0	27.0
135B 0600N5	13260	6.0	6.0	110.0	8.0	32.0
135B 0800N5	13262	8.0	8.0	110.0	10.0	42.0
135B 1000N5	13264	10.0	10.0	110.0	12.0	52.0
135B 1200N5	13266	12.0	12.0	120.0	16.0	62.0
135B 1600N5	13268	16.0	16.0	130.0	20.0	82.0



TuffCut® X-AL Series 137V N3 & 137V N3 AL

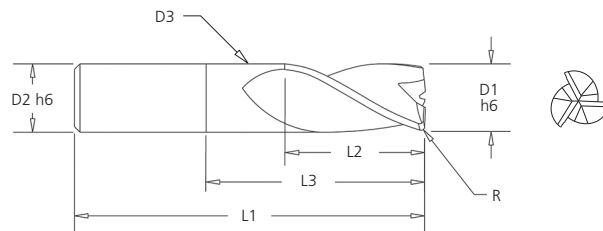
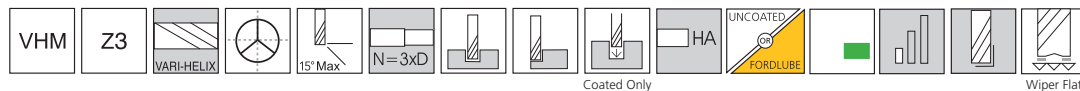

new items

Tool Number				D1	D2	D3	L1	L2	L3	R
Uncoated	Stk	Fordlube Coating	Stk							
137V 03N3	●	137V 03N3AL	●	3.0	3.0	2.8	51.0	8.0	11.0	-
137V 03N3-0.2R	●	137V 03N3-0.2RAL	●	3.0	3.0	2.8	51.0	8.0	11.0	0.2
137V 03N3-0.5R	●	137V 03N3-0.5RAL	●	3.0	3.0	2.8	51.0	8.0	11.0	0.5
137V 03N3-1.0R	●	137V 03N3-1.0RAL	●	3.0	3.0	2.8	51.0	8.0	11.0	1.0
137V 04N3	●	137V 04N3AL	●	4.0	4.0	3.8	51.0	11.0	14.0	-
137V 04N3-0.2R	●	137V 04N3-0.2RAL	●	4.0	4.0	3.8	51.0	11.0	14.0	0.2
137V 04N3-0.5R	●	137V 04N3-0.5RAL	●	4.0	4.0	3.8	51.0	11.0	14.0	0.5
137V 04N3-1.0R	●	137V 04N3-1.0RAL	●	4.0	4.0	3.8	51.0	11.0	14.0	1.0
137V 05N3	●	137V 05N3AL	●	5.0	5.0	4.8	57.0	13.0	17.0	-
137V 05N3-0.2R	●	137V 05N3-0.2RAL	●	5.0	5.0	4.8	57.0	13.0	17.0	0.2
137V 05N3-0.5R	●	137V 05N3-0.5RAL	●	5.0	5.0	4.8	57.0	13.0	17.0	0.5
137V 05N3-1.0R	●	137V 05N3-1.0RAL	●	5.0	5.0	4.8	57.0	13.0	17.0	1.0
137V 06N3	●	137V 06N3AL	●	6.0	6.0	5.8	64.0	13.0	20.0	-
137V 06N3-0.2R	●	137V 06N3-0.2RAL	●	6.0	6.0	5.8	64.0	13.0	20.0	0.2
137V 06N3-0.5R	●	137V 06N3-0.5RAL	●	6.0	6.0	5.8	64.0	13.0	20.0	0.5
137V 06N3-1.0R	●	137V 06N3-1.0RAL	●	6.0	6.0	5.8	64.0	13.0	20.0	1.0
137V 06N3-1.5R	●	137V 06N3-1.5RAL	●	6.0	6.0	5.8	64.0	13.0	20.0	1.5
137V 06N3-2.0R	●	137V 06N3-2.0RAL	●	6.0	6.0	5.8	64.0	13.0	20.0	2.0
137V 08N3	●	137V 08N3AL	●	8.0	8.0	7.8	64.0	19.0	26.0	-
137V 08N3-0.2R	●	137V 08N3-0.2RAL	●	8.0	8.0	7.8	64.0	19.0	26.0	0.2
137V 08N3-0.5R	●	137V 08N3-0.5RAL	●	8.0	8.0	7.8	64.0	19.0	26.0	0.5
137V 08N3-1.0R	●	137V 08N3-1.0RAL	●	8.0	8.0	7.8	64.0	19.0	26.0	1.0
137V 08N3-1.5R	●	137V 08N3-1.5RAL	○	8.0	8.0	7.8	64.0	19.0	26.0	1.5
137V 08N3-2.0R	●	137V 08N3-2.0RAL	●	8.0	8.0	7.8	64.0	19.0	26.0	2.0
137V 08N3-3.0R	●	137V 08N3-3.0RAL	●	8.0	8.0	7.8	64.0	19.0	26.0	3.0
137V 10N3	●	137V 10N3AL	●	10.0	10.0	9.8	73.0	22.0	32.0	-
137V 10N3-0.2R	●	137V 10N3-0.2RAL	●	10.0	10.0	9.8	73.0	22.0	32.0	0.2
137V 10N3-0.3R	○	137V 10N3-0.3RAL	○	10.0	10.0	9.8	73.0	22.0	32.0	0.3
137V 10N3-0.5R	●	137V 10N3-0.5RAL	●	10.0	10.0	9.8	73.0	22.0	32.0	0.5
137V 10N3-1.0R	●	137V 10N3-1.0RAL	●	10.0	10.0	9.8	73.0	22.0	32.0	1.0
137V 10N3-1.5R	●	137V 10N3-1.5RAL	●	10.0	10.0	9.8	73.0	22.0	32.0	1.5
137V 10N3-2.0R	●	137V 10N3-2.0RAL	●	10.0	10.0	9.8	73.0	22.0	32.0	2.0
137V 10N3-3.0R	●	137V 10N3-3.0RAL	●	10.0	10.0	9.8	73.0	22.0	32.0	3.0
137V 10N3-4.0R	●	137V 10N3-4.0RAL	○	10.0	10.0	9.8	73.0	22.0	32.0	4.0

● Stock ○ Check Availability



TuffCut® X-AL Series 137V N3 & 137V N3 AL

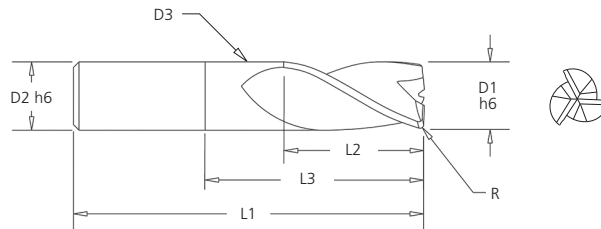
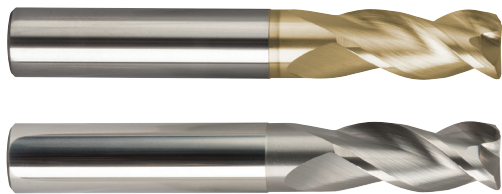
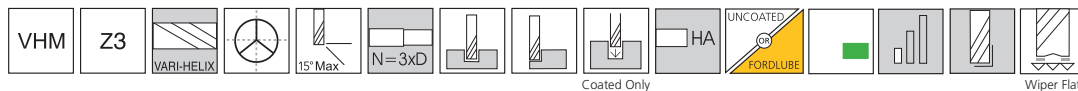

new items

Tool Number				D1	D2	D3	L1	L2	L3	R
Uncoated	Stk	Fordlube Coating	Stk							
137V 12N3	●	137V 12N3AL	●	12.0	12.0	11.8	84.0	26.0	38.0	-
137V 12N3-0.2R	●	137V 12N3-0.2RAL	●	12.0	12.0	11.8	84.0	26.0	38.0	0.2
137V 12N3-0.5R	●	137V 12N3-0.5RAL	○	12.0	12.0	11.8	84.0	26.0	38.0	0.5
137V 12N3-1.0R	●	137V 12N3-1.0RAL	●	12.0	12.0	11.8	84.0	26.0	38.0	1.0
137V 12N3-1.5R	●	137V 12N3-1.5RAL	○	12.0	12.0	11.8	84.0	26.0	38.0	1.5
137V 12N3-2.0R	●	137V 12N3-2.0RAL	●	12.0	12.0	11.8	84.0	26.0	38.0	2.0
137V 12N3-2.5R	●	137V 12N3-2.5RAL	○	12.0	12.0	11.8	84.0	26.0	38.0	2.5
137V 12N3-3.0R	●	137V 12N3-3.0RAL	●	12.0	12.0	11.8	84.0	26.0	38.0	3.0
137V 12N3-4.0R	●	137V 12N3-4.0RAL	●	12.0	12.0	11.8	84.0	26.0	38.0	4.0
137V 16N3	●	137V 16N3AL	●	16.0	16.0	15.8	93.0	32.0	50.0	-
137V 16N3-0.2R	●	137V 16N3-0.2RAL	●	16.0	16.0	15.8	93.0	32.0	50.0	0.2
137V 16N3-0.5R	●	137V 16N3-0.5RAL	●	16.0	16.0	15.8	93.0	32.0	50.0	0.5
137V 16N3-1.0R	●	137V 16N3-1.0RAL	●	16.0	16.0	15.8	93.0	32.0	50.0	1.0
137V 16N3-1.5R	●	137V 16N3-1.5RAL	●	16.0	16.0	15.8	93.0	32.0	50.0	1.5
137V 16N3-2.0R	●	137V 16N3-2.0RAL	●	16.0	16.0	15.8	93.0	32.0	50.0	2.0
137V 16N3-3.0R	●	137V 16N3-3.0RAL	●	16.0	16.0	15.8	93.0	32.0	50.0	3.0
137V 16N3-4.0R	●	137V 16N3-4.0RAL	●	16.0	16.0	15.8	93.0	32.0	50.0	4.0
137V 20N3	●	137V 20N3AL	●	20.0	20.0	19.8	105.0	38.0	62.0	-
137V 20N3-0.2R	●	137V 20N3-0.2RAL	●	20.0	20.0	19.8	105.0	38.0	62.0	0.2
137V 20N3-0.5R	●	137V 20N3-0.5RAL	●	20.0	20.0	19.8	105.0	38.0	62.0	0.5
137V 20N3-1.0R	●	137V 20N3-1.0RAL	●	20.0	20.0	19.8	105.0	38.0	62.0	1.0
137V 20N3-1.5R	●	137V 20N3-1.5RAL	○	20.0	20.0	19.8	105.0	38.0	62.0	1.5
137V 20N3-2.0R	●	137V 20N3-2.0RAL	●	20.0	20.0	19.8	105.0	38.0	62.0	2.0
137V 20N3-3.0R	●	137V 20N3-3.0RAL	●	20.0	20.0	19.8	105.0	38.0	62.0	3.0
137V 20N3-4.0R	●	137V 20N3-4.0RAL	●	20.0	20.0	19.8	105.0	38.0	62.0	4.0
137V 20N3-5.0R	●	137V 20N3-5.0RAL	○	20.0	20.0	19.8	105.0	38.0	62.0	5.0
137V 20N3-6.0R	●	137V 20N3-6.0RAL	○	20.0	20.0	19.8	105.0	38.0	62.0	6.0

● Stock ○ Check Availability



TuffCut® X-AL Series 137V N4 & 137V N4 AL

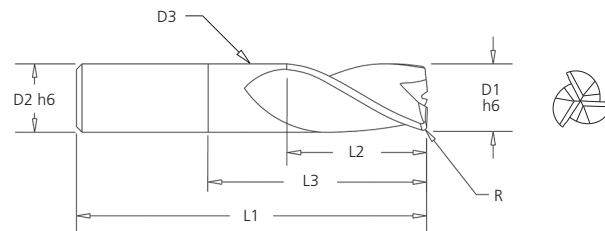
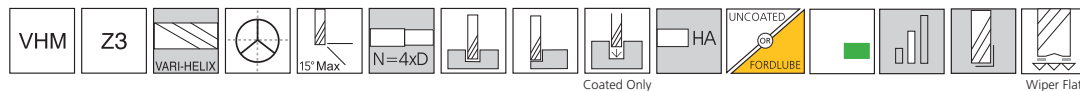

new items

Tool Number				D1	D2	D3	L1	L2	L3	R
Uncoated	Stk	Fordlube Coating	Stk							
137V 03N4	●	137V 03N4AL	○	3.0	3.0	2.8	51.0	4.5	14.0	-
137V 03N4-0.2R	●	137V 03N4-0.2RAL	●	3.0	3.0	2.8	51.0	4.5	14.0	0.2
137V 03N4-0.5R	●	137V 03N4-0.5RAL	●	3.0	3.0	2.8	51.0	4.5	14.0	0.5
137V 03N4-1.0R	●	137V 03N4-1.0RAL	○	3.0	3.0	2.8	51.0	4.5	14.0	1.0
137V 04N4	●	137V 04N4AL	●	4.0	4.0	3.8	51.0	6.0	18.0	-
137V 04N4-0.2R	●	137V 04N4-0.2RAL	●	4.0	4.0	3.8	51.0	6.0	18.0	0.2
137V 04N4-0.5R	●	137V 04N4-0.5RAL	●	4.0	4.0	3.8	51.0	6.0	18.0	0.5
137V 04N4-1.0R	●	137V 04N4-1.0RAL	●	4.0	4.0	3.8	51.0	6.0	18.0	1.0
137V 05N4	●	137V 05N4AL	●	5.0	5.0	4.8	57.0	7.5	22.0	-
137V 05N4-0.2R	●	137V 05N4-0.2RAL	●	5.0	5.0	4.8	57.0	7.5	22.0	0.2
137V 05N4-0.5R	●	137V 05N4-0.5RAL	○	5.0	5.0	4.8	57.0	7.5	22.0	0.5
137V 05N4-1.0R	●	137V 05N4-1.0RAL	●	5.0	5.0	4.8	57.0	7.5	22.0	1.0
137V 06N4	●	137V 06N4AL	●	6.0	6.0	5.8	64.0	9.0	26.0	-
137V 06N4-0.2R	●	137V 06N4-0.2RAL	●	6.0	6.0	5.8	64.0	9.0	26.0	0.2
137V 06N4-0.5R	●	137V 06N4-0.5RAL	●	6.0	6.0	5.8	64.0	9.0	26.0	0.5
137V 06N4-1.0R	●	137V 06N4-1.0RAL	●	6.0	6.0	5.8	64.0	9.0	26.0	1.0
137V 06N4-1.5R	●	137V 06N4-1.5RAL	○	6.0	6.0	5.8	64.0	9.0	26.0	1.5
137V 06N4-2.0R	●	137V 06N4-2.0RAL	○	6.0	6.0	5.8	64.0	9.0	26.0	2.0
137V 08N4	●	137V 08N4AL	●	8.0	8.0	7.8	70.0	12.0	34.0	-
137V 08N4-0.2R	●	137V 08N4-0.2RAL	●	8.0	8.0	7.8	70.0	12.0	34.0	0.2
137V 08N4-0.5R	●	137V 08N4-0.5RAL	○	8.0	8.0	7.8	70.0	12.0	34.0	0.5
137V 08N4-1.0R	●	137V 08N4-1.0RAL	●	8.0	8.0	7.8	70.0	12.0	34.0	1.0
137V 08N4-1.5R	●	137V 08N4-1.5RAL	○	8.0	8.0	7.8	70.0	12.0	34.0	1.5
137V 08N4-2.0R	●	137V 08N4-2.0RAL	●	8.0	8.0	7.8	70.0	12.0	34.0	2.0
137V 08N4-3.0R	●	137V 08N4-3.0RAL	●	8.0	8.0	7.8	70.0	12.0	34.0	3.0
137V 10N4	●	137V 10N4AL	●	10.0	10.0	9.8	90.0	15.0	42.0	-
137V 10N4-0.2R	●	137V 10N4-0.2RAL	●	10.0	10.0	9.8	90.0	15.0	42.0	0.2
137V 10N4-0.5R	●	137V 10N4-0.5RAL	●	10.0	10.0	9.8	90.0	15.0	42.0	0.5
137V 10N4-1.0R	●	137V 10N4-1.0RAL	●	10.0	10.0	9.8	90.0	15.0	42.0	1.0
137V 10N4-1.5R	●	137V 10N4-1.5RAL	●	10.0	10.0	9.8	90.0	15.0	42.0	1.5
137V 10N4-2.0R	●	137V 10N4-2.0RAL	●	10.0	10.0	9.8	90.0	15.0	42.0	2.0
137V 10N4-3.0R	●	137V 10N4-3.0RAL	●	10.0	10.0	9.8	90.0	15.0	42.0	3.0
137V 10N4-4.0R	●	137V 10N4-4.0RAL	○	10.0	10.0	9.8	90.0	15.0	42.0	4.0

● Stock ○ Check Availability



TuffCut® X-AL Series 137V N4 & 137V N4 AL

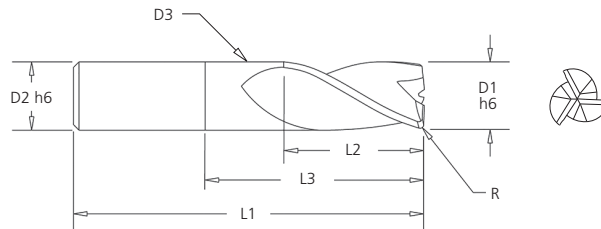
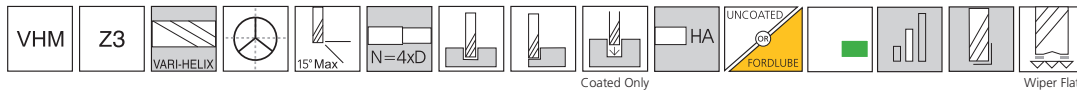

new items

Tool Number				D1	D2	D3	L1	L2	L3	R
Uncoated	Stk	Fordlube Coating	Stk							
137V 12N4	●	137V 12N4AL	●	12.0	12.0	11.8	100.0	18.0	50.0	-
137V 12N4-0.2R	●	137V 12N4-0.2RAL	●	12.0	12.0	11.8	100.0	18.0	50.0	0.2
137V 12N4-0.5R	●	137V 12N4-0.5RAL	●	12.0	12.0	11.8	100.0	18.0	50.0	0.5
137V 12N4-1.0R	●	137V 12N4-1.0RAL	●	12.0	12.0	11.8	100.0	18.0	50.0	1.0
137V 12N4-1.5R	●	137V 12N4-1.5RAL	●	12.0	12.0	11.8	100.0	18.0	50.0	1.5
137V 12N4-2.0R	●	137V 12N4-2.0RAL	●	12.0	12.0	11.8	100.0	18.0	50.0	2.0
137V 12N4-3.0R	●	137V 12N4-3.0RAL	●	12.0	12.0	11.8	100.0	18.0	50.0	3.0
137V 12N4-4.0R	●	137V 12N4-4.0RAL	●	12.0	12.0	11.8	100.0	18.0	50.0	4.0
137V 16N4	●	137V 16N4AL	●	16.0	16.0	15.8	120.0	24.0	66.0	-
137V 16N4-0.2R	●	137V 16N4-0.2RAL	●	16.0	16.0	15.8	120.0	24.0	66.0	0.2
137V 16N4-0.5R	●	137V 16N4-0.5RAL	●	16.0	16.0	15.8	120.0	24.0	66.0	0.5
137V 16N4-1.0R	●	137V 16N4-1.0RAL	●	16.0	16.0	15.8	120.0	24.0	66.0	1.0
137V 16N4-1.5R	●	137V 16N4-1.5RAL	○	16.0	16.0	15.8	120.0	24.0	66.0	1.5
137V 16N4-2.0R	●	137V 16N4-2.0RAL	○	16.0	16.0	15.8	120.0	24.0	66.0	2.0
137V 16N4-3.0R	●	137V 16N4-3.0RAL	○	16.0	16.0	15.8	120.0	24.0	66.0	3.0
137V 16N4-4.0R	●	137V 16N4-4.0RAL	●	16.0	16.0	15.8	120.0	24.0	66.0	4.0
137V 20N4	●	137V 20N4AL	●	20.0	20.0	19.8	135.0	30.0	82.0	-
137V 20N4-0.2R	●	137V 20N4-0.2RAL	○	20.0	20.0	19.8	135.0	30.0	82.0	0.2
137V 20N4-0.5R	●	137V 20N4-0.5RAL	○	20.0	20.0	19.8	135.0	30.0	82.0	0.5
137V 20N4-1.0R	●	137V 20N4-1.0RAL	●	20.0	20.0	19.8	135.0	30.0	82.0	1.0
137V 20N4-1.5R	●	137V 20N4-1.5RAL	○	20.0	20.0	19.8	135.0	30.0	82.0	1.5
137V 20N4-2.0R	●	137V 20N4-2.0RAL	●	20.0	20.0	19.8	135.0	30.0	82.0	2.0
137V 20N4-3.0R	●	137V 20N4-3.0RAL	○	20.0	20.0	19.8	135.0	30.0	82.0	3.0
137V 20N4-4.0R	●	137V 20N4-4.0RAL	○	20.0	20.0	19.8	135.0	30.0	82.0	4.0

● Stock ○ Check Availability



TuffCut® X-AL Series 137V N5 & 137V N5 AL

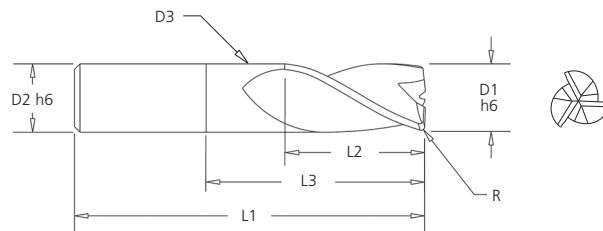
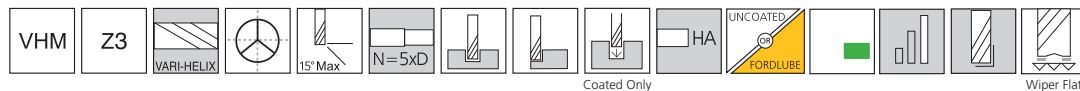

new items

Tool Number				D1	D2	D3	L1	L2	L3	R
Uncoated	Stk	Fordlube Coating	Stk							
137V 03N5	●	137V 03N5AL	●	3.0	3.0	2.8	51.0	4.5	17.0	-
137V 03N5-0.2R	●	137V 03N5-0.2RAL	●	3.0	3.0	2.8	51.0	4.5	17.0	0.2
137V 03N5-0.5R	●	137V 03N5-0.5RAL	●	3.0	3.0	2.8	51.0	4.5	17.0	0.5
137V 03N5-1.0R	●	137V 03N5-1.0RAL	○	3.0	3.0	2.8	51.0	4.5	17.0	1.0
137V 04N5	●	137V 04N5AL	●	4.0	4.0	3.8	51.0	6.0	22.0	-
137V 04N5-0.2R	●	137V 04N5-0.2RAL	●	4.0	4.0	3.8	51.0	6.0	22.0	0.2
137V 04N5-0.5R	●	137V 04N5-0.5RAL	●	4.0	4.0	3.8	51.0	6.0	22.0	0.5
137V 04N5-1.0R	●	137V 04N5-1.0RAL	●	4.0	4.0	3.8	51.0	6.0	22.0	1.0
137V 05N5	●	137V 05N5AL	●	5.0	5.0	4.8	57.0	7.5	27.0	-
137V 05N5-0.2R	●	137V 05N5-0.2RAL	●	5.0	5.0	4.8	57.0	7.5	27.0	0.2
137V 05N5-0.5R	●	137V 05N5-0.5RAL	●	5.0	5.0	4.8	57.0	7.5	27.0	0.5
137V 05N5-1.0R	●	137V 05N5-1.0RAL	●	5.0	5.0	4.8	57.0	7.5	27.0	1.0
137V 06N5	●	137V 06N5AL	●	6.0	6.0	5.8	64.0	9.0	32.0	-
137V 06N5-0.2R	●	137V 06N5-0.2RAL	●	6.0	6.0	5.8	64.0	9.0	32.0	0.2
137V 06N5-0.5R	●	137V 06N5-0.5RAL	●	6.0	6.0	5.8	64.0	9.0	32.0	0.5
137V 06N5-1.0R	●	137V 06N5-1.0RAL	○	6.0	6.0	5.8	64.0	9.0	32.0	1.0
137V 06N5-1.5R	●	137V 06N5-1.5RAL	●	6.0	6.0	5.8	64.0	9.0	32.0	1.5
137V 06N5-2.0R	●	137V 06N5-2.0RAL	●	6.0	6.0	5.8	64.0	9.0	32.0	2.0
137V 08N5	●	137V 08N5AL	●	8.0	8.0	7.8	75.0	12.0	42.0	-
137V 08N5-0.2R	●	137V 08N5-0.2RAL	●	8.0	8.0	7.8	75.0	12.0	42.0	0.2
137V 08N5-0.5R	●	137V 08N5-0.5RAL	●	8.0	8.0	7.8	75.0	12.0	42.0	0.5
137V 08N5-1.0R	●	137V 08N5-1.0RAL	○	8.0	8.0	7.8	75.0	12.0	42.0	1.0
137V 08N5-1.5R	●	137V 08N5-1.5RAL	○	8.0	8.0	7.8	75.0	12.0	42.0	1.5
137V 08N5-2.0R	●	137V 08N5-2.0RAL	●	8.0	8.0	7.8	75.0	12.0	42.0	2.0
137V 08N5-3.0R	●	137V 08N5-3.0RAL	○	8.0	8.0	7.8	75.0	12.0	42.0	3.0
137V 10N5	●	137V 10N5AL	●	10.0	10.0	9.8	90.0	15.0	52.0	-
137V 10N5-0.2R	●	137V 10N5-0.2RAL	●	10.0	10.0	9.8	90.0	15.0	52.0	0.2
137V 10N5-0.5R	●	137V 10N5-0.5RAL	●	10.0	10.0	9.8	90.0	15.0	52.0	0.5
137V 10N5-1.0R	●	137V 10N5-1.0RAL	●	10.0	10.0	9.8	90.0	15.0	52.0	1.0
137V 10N5-1.5R	●	137V 10N5-1.5RAL	●	10.0	10.0	9.8	90.0	15.0	52.0	1.5
137V 10N5-2.0R	●	137V 10N5-2.0RAL	●	10.0	10.0	9.8	90.0	15.0	52.0	2.0
137V 10N5-3.0R	●	137V 10N5-3.0RAL	●	10.0	10.0	9.8	90.0	15.0	52.0	3.0
137V 10N5-4.0R	●	137V 10N5-4.0RAL	○	10.0	10.0	9.8	90.0	15.0	52.0	4.0

● Stock ○ Check Availability



TuffCut® X-AL Series 137V N5 & 137V N5 AL

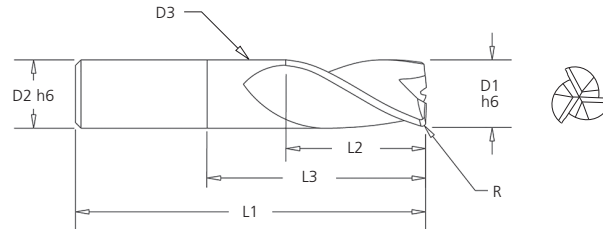
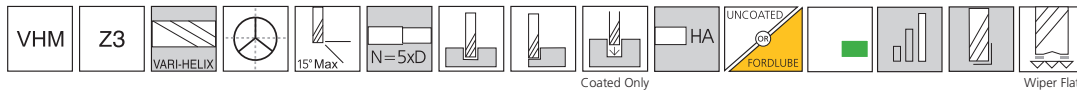

new items

Tool Number				D1	D2	D3	L1	L2	L3	R
Uncoated	Stk	Fordlube Coating	Stk							
137V 12N5	●	137V 12N5AL	●	12.0	12.0	11.8	110.0	18.0	62.0	-
137V 12N5-0.2R	●	137V 12N5-0.2RAL	●	12.0	12.0	11.8	110.0	18.0	62.0	0.2
137V 12N5-0.5R	●	137V 12N5-0.5RAL	●	12.0	12.0	11.8	110.0	18.0	62.0	0.5
137V 12N5-1.0R	●	137V 12N5-1.0RAL	●	12.0	12.0	11.8	110.0	18.0	62.0	1.0
137V 12N5-1.5R	●	137V 12N5-1.5RAL	○	12.0	12.0	11.8	110.0	18.0	62.0	1.5
137V 12N5-2.0R	●	137V 12N5-2.0RAL	●	12.0	12.0	11.8	110.0	18.0	62.0	2.0
137V 12N5-3.0R	●	137V 12N5-3.0RAL	●	12.0	12.0	11.8	110.0	18.0	62.0	3.0
137V 12N5-4.0R	●	137V 12N5-4.0RAL	●	12.0	12.0	11.8	110.0	18.0	62.0	4.0
137V 16N5	●	137V 16N5AL	●	16.0	16.0	15.8	130.0	24.0	82.0	-
137V 16N5-0.2R	●	137V 16N5-0.2RAL	●	16.0	16.0	15.8	130.0	24.0	82.0	0.2
137V 16N5-0.5R	●	137V 16N5-0.5RAL	●	16.0	16.0	15.8	130.0	24.0	82.0	0.5
137V 16N5-1.0R	●	137V 16N5-1.0RAL	●	16.0	16.0	15.8	130.0	24.0	82.0	1.0
137V 16N5-1.5R	●	137V 16N5-1.5RAL	○	16.0	16.0	15.8	130.0	24.0	82.0	1.5
137V 16N5-2.0R	●	137V 16N5-2.0RAL	●	16.0	16.0	15.8	130.0	24.0	82.0	2.0
137V 16N5-3.0R	●	137V 16N5-3.0RAL	●	16.0	16.0	15.8	130.0	24.0	82.0	3.0
137V 16N5-4.0R	●	137V 16N5-4.0RAL	●	16.0	16.0	15.8	130.0	24.0	82.0	4.0
137V 20N5	●	137V 20N5AL	●	20.0	20.0	19.8	150.0	30.0	102.0	-
137V 20N5-0.2R	●	137V 20N5-0.2RAL	●	20.0	20.0	19.8	150.0	30.0	102.0	0.2
137V 20N5-0.5R	●	137V 20N5-0.5RAL	●	20.0	20.0	19.8	150.0	30.0	102.0	0.5
137V 20N5-1.0R	●	137V 20N5-1.0RAL	●	20.0	20.0	19.8	150.0	30.0	102.0	1.0
137V 20N5-1.5R	●	137V 20N5-1.5RAL	○	20.0	20.0	19.8	150.0	30.0	102.0	1.5
137V 20N5-2.0R	●	137V 20N5-2.0RAL	○	20.0	20.0	19.8	150.0	30.0	102.0	2.0
137V 20N5-3.0R	●	137V 20N5-3.0RAL	○	20.0	20.0	19.8	150.0	30.0	102.0	3.0
137V 20N5-4.0R	●	137V 20N5-4.0RAL	○	20.0	20.0	19.8	150.0	30.0	102.0	4.0

● Stock ○ Check Availability



TuffCut® X-AL Series 138B

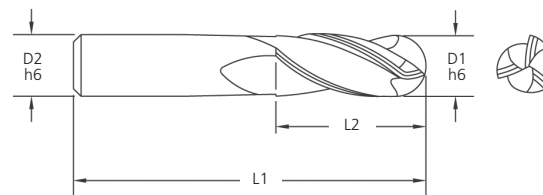
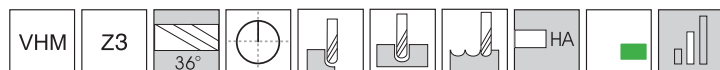

Tool Number	EDP	D1	D2	L1	L2
138B 0300	13356	3.0	3.0	38.0	12.0
138B 0400	13358	4.0	4.0	51.0	15.0
138B 0500	13360	5.0	5.0	64.0	20.0
138B 0600	13362	6.0	6.0	64.0	20.0
138B 0800	13364	8.0	8.0	64.0	20.0
138B 1000	13366	10.0	10.0	70.0	25.0
138B 1200	13368	12.0	12.0	76.0	25.0
138B 1600	13370	16.0	16.0	89.0	35.0



TuffCut® X-AL Series 138B N5

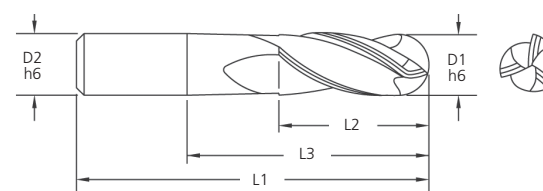
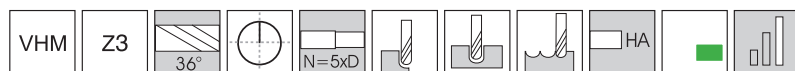

Tool Number	EDP	D1	D2	L1	L2	L3
138B 0200N5	13372	2.0	6.0	75.0	4.0	12.0
138B 0300N5	13374	3.0	6.0	75.0	5.0	17.0
138B 0400N5	13376	4.0	6.0	75.0	6.0	22.0
138B 0500N5	13378	5.0	6.0	75.0	7.0	27.0
138B 0600N5	13380	6.0	6.0	110.0	8.0	32.0
138B 0800N5	13382	8.0	8.0	110.0	10.0	42.0
138B 1000N5	13384	10.0	10.0	110.0	12.0	52.0
138B 1200N5	13386	12.0	12.0	120.0	16.0	62.0
138B 1600N5	13388	16.0	16.0	130.0	20.0	82.0



TuffCut® X-AL Series 137VR N3

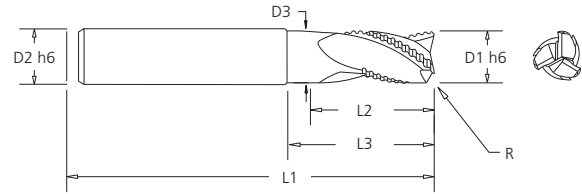
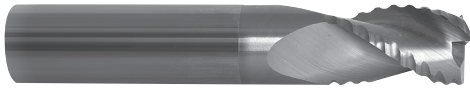
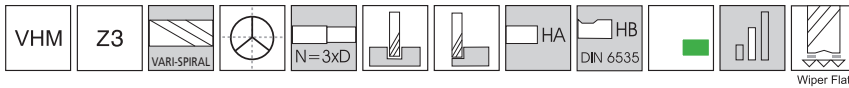

Tool Number	D1	D2	D3	L1	L2	L3	R	Shank
137VR 12N3-1.0R	12.0	12.0	11.8	84.0	26.0	38.0	1.0	HA
137VR 12N3-1.0RW	12.0	12.0	11.8	84.0	26.0	38.0	1.0	HB
137VR 16N3-1.0R	16.0	16.0	15.8	93.0	32.0	50.0	1.0	HA
137VR 16N3-1.0RW	16.0	16.0	15.8	100.0	32.0	50.0	1.0	HB
137VR 20N3-1.0R	20.0	20.0	19.8	105.0	38.0	62.0	1.0	HA
137VR 20N3-1.0RW	20.0	20.0	19.8	112.0	38.0	62.0	1.0	HB



TuffCut® X-AL Series 137VR N5

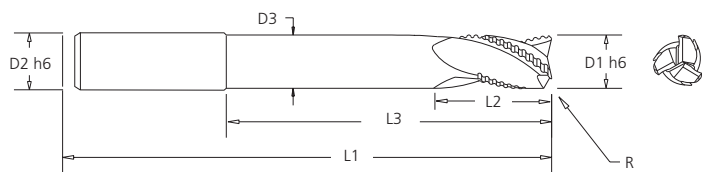
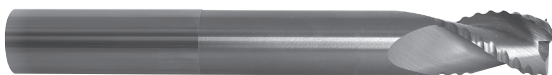
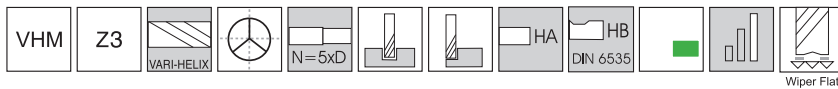

Tool Number	EDP	D1	D2	D3	L1	L2	L3	R	Shank
137VR 12N5-1.0R	12.0	12.0	11.8	11.8	110.0	18.0	62.0	1.0	HA
137VR 12N5-1.0RW	12.0	12.0	11.8	11.8	110.0	18.0	62.0	1.0	HB
137VR 16N5-1.0R	16.0	16.0	15.8	15.8	130.0	24.0	82.0	1.0	HA
137VR 16N5-1.0RW	16.0	16.0	15.8	15.8	130.0	24.0	82.0	1.0	HB
137VR 20N5-1.0R	20.0	20.0	19.8	19.8	150.0	30.0	102.0	1.0	HA
137VR 20N5-1.0RW	20.0	20.0	19.8	19.8	155.0	30.0	102.0	1.0	HB



TuffCut® X-AL Series 137VF Finishing

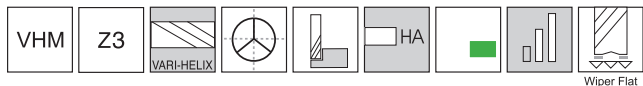

3 x D1 and 5 x D1 Flute Lengths

Type 1

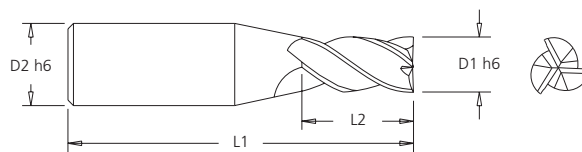

Type 2

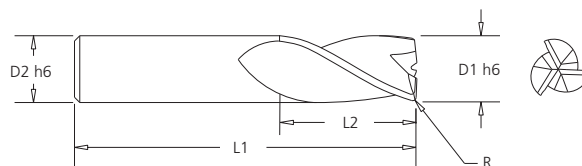

Tool Number	D1	D2	L1	L2	R	Type
137VF 0303	3.0	6.0	75.0	11.0	-	1
137VF 0303-0.2R	3.0	6.0	75.0	11.0	0.2	1
137VF 0305	3.0	6.0	75.0	17.0	-	1
137VF 0305-0.2R	3.0	6.0	75.0	17.0	0.2	1
137VF 0403	4.0	6.0	75.0	14.0	-	1
137VF 0403-0.2R	4.0	6.0	75.0	14.0	0.2	1
137VF 0403-0.5R	4.0	6.0	75.0	14.0	0.5	1
137VF 0405	4.0	6.0	75.0	22.0	-	1
137VF 0405-0.2R	4.0	6.0	75.0	22.0	0.2	1
137VF 0405-0.5R	4.0	6.0	75.0	22.0	0.5	1
137VF 0503	5.0	6.0	75.0	17.0	-	1
137VF 0503-0.2R	5.0	6.0	75.0	17.0	0.2	1
137VF 0503-0.5R	5.0	6.0	75.0	17.0	0.5	1
137VF 0505	5.0	6.0	75.0	27.0	-	1
137VF 0505-0.2R	5.0	6.0	75.0	27.0	0.2	1
137VF 0505-0.5R	5.0	6.0	75.0	27.0	0.5	1
137VF 0603	6.0	6.0	75.0	20.0	-	2
137VF 0603-0.2R	6.0	6.0	75.0	20.0	0.2	2
137VF 0603-0.5R	6.0	6.0	75.0	20.0	0.5	2
137VF 0605	6.0	6.0	75.0	32.0	-	2
137VF 0605-0.2R	6.0	6.0	75.0	32.0	0.2	2
137VF 0605-0.5R	6.0	6.0	75.0	32.0	0.5	2
137VF 0605-1.0R	6.0	6.0	75.0	32.0	1.0	2
137VF 0803	8.0	8.0	75.0	26.0	-	2
137VF 0803-0.2R	8.0	8.0	75.0	26.0	0.2	2
137VF 0803-0.5R	8.0	8.0	75.0	26.0	0.5	2
137VF 0803-1.0R	8.0	8.0	75.0	26.0	1.0	2
137VF 0805	8.0	8.0	90.0	42.0	-	2
137VF 0805-0.2R	8.0	8.0	90.0	42.0	0.2	2
137VF 0805-0.5R	8.0	8.0	90.0	42.0	0.5	2
137VF 0805-1.0R	8.0	8.0	90.0	42.0	1.0	2
137VF 1003	10.0	10.0	90.0	32.0	-	2
137VF 1003-0.2R	10.0	10.0	90.0	32.0	0.2	2
137VF 1003-0.5R	10.0	10.0	90.0	32.0	0.5	2
137VF 1003-1.0R	10.0	10.0	90.0	32.0	1.0	2
137VF 1003-2.0R	10.0	10.0	90.0	32.0	2.0	2
137VF 1005	10.0	10.0	100.0	52.0	-	2
137VF 1005-0.2R	10.0	10.0	100.0	52.0	0.2	2
137VF 1005-0.5R	10.0	10.0	100.0	52.0	0.5	2

TuffCut® X-AL Series 137VF Finishing

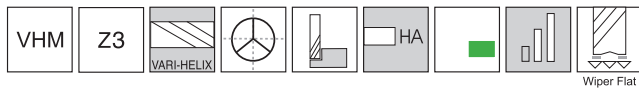

3 x D1 and 5 x D1 Flute Lengths

Type 1

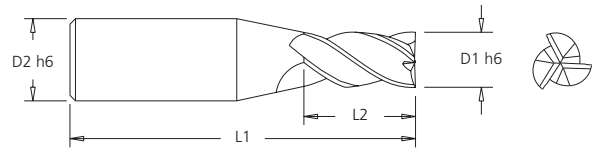

Type 2

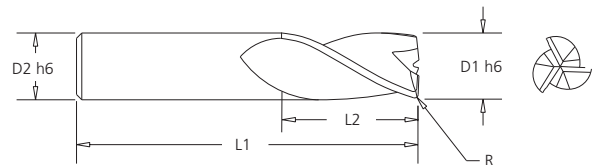

Tool Number	D1	D2	L1	L2	R	Type
137VF 1005-1.0R	10.0	10.0	100.0	52.0	1.0	2
137VF 1005-2.0R	10.0	10.0	100.0	52.0	2.0	2
137VF 1203	12.0	12.0	100.0	38.0	-	2
137VF 1203-0.2R	12.0	12.0	100.0	38.0	0.2	2
137VF 1203-0.5R	12.0	12.0	100.0	38.0	0.5	2
137VF 1203-1.0R	12.0	12.0	100.0	38.0	1.0	2
137VF 1203-2.0R	12.0	12.0	100.0	38.0	2.0	2
137VF 1205	12.0	12.0	120.0	62.0	-	2
137VF 1205-0.2R	12.0	12.0	120.0	62.0	0.2	2
137VF 1205-0.5R	12.0	12.0	120.0	62.0	0.5	2
137VF 1205-1.0R	12.0	12.0	120.0	62.0	1.0	2
137VF 1205-2.0R	12.0	12.0	120.0	62.0	2.0	2
137VF 1603	16.0	16.0	120.0	50.0	-	2
137VF 1603-0.2R	16.0	16.0	120.0	50.0	0.2	2
137VF 1603-0.5R	16.0	16.0	120.0	50.0	0.5	2
137VF 1603-1.0R	16.0	16.0	120.0	50.0	1.0	2
137VF 1603-2.0R	16.0	16.0	120.0	50.0	2.0	2
137VF 1605	16.0	16.0	150.0	82.0	-	2
137VF 1605-0.2R	16.0	16.0	150.0	82.0	0.2	2
137VF 1605-0.5R	16.0	16.0	150.0	82.0	0.5	2
137VF 1605-1.0R	16.0	16.0	150.0	82.0	1.0	2
137VF 1605-2.0R	16.0	16.0	150.0	82.0	2.0	2
137VF 2003	20.0	20.0	135.0	62.0	-	2
137VF 2003-0.2R	20.0	20.0	135.0	62.0	0.2	2
137VF 2003-0.5R	20.0	20.0	135.0	62.0	0.5	2
137VF 2003-1.0R	20.0	20.0	135.0	62.0	1.0	2
137VF 2003-2.0R	20.0	20.0	135.0	62.0	2.0	2
137VF 2005	20.0	20.0	164.0	102.0	-	2
137VF 2005-0.2R	20.0	20.0	164.0	102.0	0.2	2
137VF 2005-0.5R	20.0	20.0	164.0	102.0	0.5	2
137VF 2005-1.0R	20.0	20.0	164.0	102.0	1.0	2
137VF 2005-2.0R	20.0	20.0	164.0	102.0	2.0	2



TuffCut® XR Series 113A

Recommended cutting data :: Conditions de coupe recommandées :: Empfohlene Schnittdaten :: Dati di taglio Raccomandati :: Zalecane Parametry

Workpiece Material Group	Material Type	Coolant			0.05 x D 2 x D	0.1 x D 2 x D	
		Max	Air	MMS	Vc-M/Min		
Steels	P	Low Carbon	●	●	●	280	240
		Medium Carbon	●	●	●	200	185
		Alloy Steels	●	●	●	185	170
		Die/Tool Steels	●	●	●	160	135
Stainless Steels	M	Free Machining	●	X	○	120	100
		Austenitic	●	X	○	95	90
		Difficult Stainless	●	X	○	75	65
		PH Stainless	●	X	○	95	90
		Cobalt Chrome Alloys	●	X	○	70	65
		Duplex (22%)	●	X	○	70	65
		Super Duplex (25%)	●	X	○	45	40
Special Alloys	S	High Temp Alloys	●	X	X	35	30
		Inconel 625/718	●	X	X	35	30
		Titanium Alloys	●	X	X	95	70
Cast Irons	K	Gray Cast Iron	●	○	○	290	190
		Ductile Cast Iron	●	○	○	215	150
		Malleable Iron	●	○	○	120	110
Hardened Steels	H	Hardened Steels 45 - 50 Rc	●	○	○	110	70
		Hardened Steels 50 - 55 Rc	●	○	○	90	60

● Preferred ○ Possible X Not Possible

Workpiece Material Group	Material Type	Tool Diameter																		
		1.5mm	3mm	5mm	6mm	8mm	10mm	12mm	16mm	20mm										
		fz-mm/tooth																		
Steels	P	Low Carbon	0.020	0.027	0.067	0.080	0.093	0.133	0.160	0.187	0.267									
		Medium Carbon																		
		Alloy Steels																		
		Die/Tool Steels																		
Stainless Steels	M	Free Machining	0.020	0.027	0.067	0.080	0.093	0.133	0.160	0.187	0.267									
		Austenitic																		
		Difficult Stainless																		
		PH Stainless																		
		Cobalt Chrome Alloys																		
		Duplex (22%)										0.014	0.020	0.050	0.060	0.070	0.100	0.120	0.140	0.200
		Super Duplex (25%)																		
Special Alloys	S	High Temp Alloys	0.009	0.013	0.033	0.040	0.047	0.067	0.080	0.093	0.133									
		Inconel																		
		Titanium Alloys																		
Cast Irons	K	Gray Cast Iron	0.019	0.027	0.067	0.080	0.093	0.133	0.160	0.187	0.267									
		Ductile Cast Iron																		
		Malleable Iron																		
Hardened Steels	H	Hardened Steels 45 - 50 Rc	0.017	0.024	0.060	0.072	0.084	0.120	0.144	0.168	0.240									
		Hardened Steels 50 - 55 Rc	0.010	0.018	0.043	0.053	0.061	0.089	0.107	0.124	0.178									

Please Note- Peripheral Milling only.

During profile milling less than 50% of the cutter diameter radial width, the actual chip thickness at the cutting edge is less than the programmed chipload. The accompanying table shows the increase in tooth load by given radial percentage engagement. Multiply your feed per tooth by the factor before finalising your table feed.

Radial Cut (Ae)	Chip thickness Compensation factor
30%	1.10
20%	1.20
15%	1.40
10%	1.80
5%	2.30
1%	5.00

TuffCut® Series 3MVS/3MVR

Recommended cutting data | Conditions de coupe recommandées | Empfohlene Schnittdaten | Dati di taglio Raccomandati | Zalecane Parametry

Regular Length - 3MVR Series														
Workpiece Material Group	ISO	Coolant			Application	Depth of Cut Per Application		vc - m/min	End Mill Diameter (mm)					
		● Preferred ○ Possible x Not Possible				Axial (Ap)	Radial (Ae)		0.5	1.0	1.5	2.0	2.5	3.0
		Max.	Air	MMS					fz - mm/tooth by Cutter Diameter					
Moderate Machining & PH Stainless Steels	M	●	X	○	Slotting	0.5 x D	-	75	0.0012	0.0024	0.0036	0.0048	0.0060	0.0072
					Profiling	0.2-2.5 x D	0.1 x D	150	0.0033	0.0066	0.0099	0.0132	0.0165	0.0198
High Temp Alloys	S	●	X	X	Slotting	0.5 x D	-	30	0.0010	0.0020	0.0030	0.0040	0.0050	0.0060
					Profiling	0.2-2.5 x D	0.05 x D	45	0.0028	0.0056	0.0084	0.0112	0.0140	0.0168
Titanium Alloys	S	●	X	X	Slotting	0.5 x D	-	75	0.0012	0.0024	0.0036	0.0048	0.0060	0.0072
					Profiling	0.2-2.5 x D	0.1 x D	107	0.0020	0.0040	0.0060	0.0080	0.0100	0.0120

Stub Length - 3MVS Series														
Workpiece Material Group	ISO	Coolant			Application	Depth of Cut Per Application		vc - m/min	End Mill Diameter (mm)					
		● Preferred ○ Possible x Not Possible				Axial (Ap)	Radial (Ae)		0.5	1.0	1.5	2.0	2.5	3.0
		Max.	Air	MMS					fz - mm/tooth by Cutter Diameter					
Moderate Machining & PH Stainless Steels	M	●	X	○	Slotting	0.5 x D	-	75	0.0012	0.0024	0.0036	0.0048	0.0060	0.0072
					Profiling	0.2-2.5 x D	0.1 x D	150	0.0033	0.0066	0.0099	0.0132	0.0165	0.0198
High Temp Alloys	S	●	X	X	Slotting	0.5 x D	-	30	0.0010	0.0020	0.0030	0.0040	0.0050	0.0060
					Profiling	0.2-2.5 x D	0.05 x D	45	0.0028	0.0056	0.0084	0.0112	0.0140	0.0168
Titanium Alloys	S	●	X	X	Slotting	0.5 x D	-	75	0.0012	0.0024	0.0036	0.0048	0.0060	0.0072
					Profiling	0.2-2.5 x D	0.1 x D	107	0.0020	0.0040	0.0060	0.0080	0.0100	0.0120

5 X D Necked Tools (3MVS Series - N5)														
Workpiece Material Group	ISO	Coolant			Application	Depth of Cut Per Application		vc - m/min	End Mill Diameter (mm)					
		● Preferred ○ Possible x Not Possible				Axial (Ap)	Radial (Ae)		0.5	1.0	1.5	2.0	2.5	3.0
		Max.	Air	MMS					fz - mm/tooth by Cutter Diameter					
Moderate Machining & PH Stainless Steels	M	●	X	○	Slotting	0.3 x D	-	75	0.0012	0.0024	0.0036	0.0048	0.0060	0.0072
					Profiling	0.1 x D	0.08 x D	150	0.0033	0.0066	0.0099	0.0132	0.0165	0.0198
High Temp Alloys	S	●	X	X	Slotting	0.3 x D	-	30	0.0010	0.0020	0.0030	0.0040	0.0050	0.0060
					Profiling	0.1 x D	0.05 x D	45	0.0028	0.0056	0.0084	0.0112	0.0140	0.0168
Titanium Alloys	S	●	X	X	Slotting	0.3 x D	-	75	0.0012	0.0024	0.0036	0.0048	0.0060	0.0072
					Profiling	0.1 x D	0.08 x D	107	0.0020	0.0040	0.0060	0.0080	0.0100	0.0120

8 X D Necked Tools (3MVS Series - N8)														
Workpiece Material Group	ISO	Coolant			Application	Depth of Cut Per Application		vc - m/min	End Mill Diameter (mm)					
		● Preferred ○ Possible x Not Possible				Axial (Ap)	Radial (Ae)		0.5	1.0	1.5	2.0	2.5	3.0
		Max.	Air	MMS					fz - mm/tooth by Cutter Diameter					
Moderate Machining & PH Stainless Steels	M	●	X	○	Slotting	0.2 x D	-	75	0.0012	0.0024	0.0036	0.0048	0.0060	0.0072
					Profiling	0.75 x D	0.05 x D	150	0.0033	0.0066	0.0099	0.0132	0.0165	0.0198
High Temp Alloys	S	●	X	X	Slotting	0.2 x D	-	30	0.0010	0.0020	0.0030	0.0040	0.0050	0.0060
					Profiling	0.75 x D	0.05 x D	45	0.0028	0.0056	0.0084	0.0112	0.0140	0.0168
Titanium Alloys	S	●	X	X	Slotting	0.2 x D	-	75	0.0012	0.0024	0.0036	0.0048	0.0060	0.0072
					Profiling	0.75 x D	0.05 x D	107	0.0020	0.0040	0.0060	0.0080	0.0100	0.0120

TuffCut® XR Series 177, 178 & 179

Recommended cutting data · Conditions de coupe recommandées · Empfohlene Schnittdaten · Dati di taglio Raccomandati · Zalecane Parametry

Workpiece Material Group	Material Type	Coolant			1 x D 0.5 x D	1 x D 1 x D	0.05 x D 2 x D	0.1 x D 2 x D	0.2 x D 2 x D	0.3 x D 1.5 x D	0.5 x D 1.5 x D	
		Max	Air	MMS	Vc-M/Min							
Steels	P	Low Carbon	●	●	●	210	200	450	350	300	250	200
		Medium Carbon	●	●	●	180	170	270	250	230	200	170
		Alloy Steels	●	●	●	160	150	250	230	210	180	150
		Die/Tool Steels	●	●	●	130	120	225	200	170	130	120
Stainless Steels	M	Free Machining	●	X	○	110	100	150	150	120	105	100
		Austenitic	●	X	○	100	90	130	120	110	100	90
		Difficult Stainless	●	X	○	70	60	100	90	80	70	60
		PH Stainless	●	X	○	100	90	130	120	110	100	90
		Cobalt Chrome Alloys	●	X	○	70	60	100	90	80	70	60
		Duplex (22%) Super Duplex (25%)	●	X	○	70 50	60 40	100 60	90 55	80 50	70 45	60 40
Special Alloys	S	High Temp Alloys	●	X	X	30	25	50	40	35	30	25
		Titanium Alloys	●	X	X	70	60	120	120	90	75	60
Cast Irons	K	Gray Cast Iron	●	○	○	180	160	360	360	240	190	160
		Ductile Cast Iron	●	○	○	170	150	270	270	190	170	150
		Malleable Iron	●	○	○	130	120	160	150	140	130	120
Hardened Steels	H	Hardened Steels 45 - 50 Rc	●	○	○	50	45	135	135	90	50	45
		Hardened Steels 50 - 55 Rc	●	○	○	45	40	115	115	75	45	40

● Preferred ○ Possible X Not Possible

Workpiece Material Group	Material Type	Tool Diameter										
		1.5mm	3mm	5mm	6mm	8mm	10mm	12mm	16mm	20mm	25mm	
		fz-mm/tooth										
Steels	P	Profiling-177-178-179	0.005	0.018	0.025	0.060	0.080	0.100	0.120	0.160	0.200	0.250
		Slotting-177/179	0.003	0.009	0.012	0.030	0.040	0.050	0.060	0.080	0.100	0.125
Stainless Steels	M	Profiling-177-178-179	0.005	0.018	0.025	0.060	0.080	0.100	0.120	0.160	0.200	0.250
		Slotting-177/179	0.003	0.009	0.012	0.030	0.040	0.050	0.060	0.080	0.100	0.125
Special Alloys	S	Profiling-177-178-179	0.003	0.009	0.013	0.032	0.038	0.044	0.064	0.076	0.089	0.127
		Slotting-177/179	0.0015	0.0045	0.007	0.016	0.019	0.022	0.032	0.038	0.045	0.065
Titanium	S	Profiling-177-178-179	0.005	0.018	0.025	0.060	0.080	0.100	0.120	0.160	0.200	0.250
		Slotting-177/179	0.003	0.009	0.013	0.030	0.040	0.050	0.060	0.080	0.100	0.125
Cast Irons	K	Profiling-177-178-179	0.005	0.018	0.025	0.060	0.080	0.100	0.120	0.160	0.200	0.250
		Slotting-177/179	0.003	0.009	0.013	0.030	0.040	0.050	0.060	0.080	0.100	0.125
Hardened Steels	H	Profiling-177-178-179<50HRC	0.005	0.016	0.023	0.057	0.069	0.080	0.114	0.137	0.160	0.229
		Slotting-177/179 <50HRC	0.003	0.008	0.013	0.028	0.035	0.040	0.065	0.070	0.080	0.115
		Profiling-177-178-179>55HRC	0.003	0.010	0.015	0.041	0.051	0.058	0.084	0.102	0.119	0.170
		Slotting-177/179 >55HRC	0.002	0.005	0.008	0.020	0.025	0.028	0.042	0.050	0.060	0.080

Please Note- 178 series-5 flute to be used for Peripheral milling only.

During profile milling less than 50% of the cutter diameter radial width, the actual chip thickness at the cutting edge is less than the programmed chipload. The accompanying table shows the increase in tooth load by given radial percentage engagement. Multiply your feed per tooth by the factor before finalising your table feed.

Radial Cut (Ae)	Chip thickness Compensation factor
30%	1.10
20%	1.20
15%	1.40
10%	1.80
5%	2.30
1%	5.00

For 177L tools please use the following conditions		
Ap	1 x D1	0.25 x D1
Ae	0.1 x D1	1.0 x D1

When using Long Series 178 - 1 Reduce speed by 20%

TuffCut® XR & XT Series 179, 179L & 279

Recommended cutting data | Conditions de coupe recommandées | Empfohlene Schnittdaten | Dati di taglio Raccomandati | Zalecane Parametry

Semi Roughing / Roughing Steel (25-48 HRC)							Semi Finishing / Finishing Steel (25-48 HRC)			
--	--	--	--	--	--	--	--	--	--	--

Diameter	R	RPM	f	fz	Ae Max.	Ap Max.	f	fz	Ae Max.	Ap Max.
mm	mm	trs	mm/min	mm/z	mm	mm	mm/min	mm/z	mm	mm
1.5	R 0.75	35,000	1,950 - 3,300	0.0139 - 0.0235	0.075	0.450	1,950 - 3,300	0.0139 - 0.0235	0.450	0.075
2	R 1.0	30,000	2,100 - 3,600	0.0175 - 0.0300	0.100	0.600	2,100 - 3,600	0.0175 - 0.0300	0.600	0.100
2.5	R 1.25	28,000	2,100 - 3,600	0.0185 - 0.0320	0.125	0.750	2,100 - 3,600	0.0185 - 0.0320	0.750	0.125
3	R 1.5	26,500	2,100 - 3,600	0.0198 - 0.0330	0.150	0.900	2,100 - 3,600	0.0198 - 0.0330	0.900	0.150
3.5	R 1.75	24,000	2,250 - 3,900	0.0230 - 0.0400	0.175	1.000	2,250 - 3,900	0.0230 - 0.0400	1.000	0.175
4	R 2.0	23,000	2,250 - 3,900	0.0240 - 0.0420	0.200	1.200	2,250 - 3,900	0.0240 - 0.0420	1.200	0.200
4.5	R 2.25	22,000	2,250 - 3,900	0.0250 - 0.0440	0.220	1.350	2,250 - 3,900	0.0250 - 0.0440	1.350	0.220
5	R 2.5	20,000	1,800 - 5,500	0.0225 - 0.0687	0.250	1.500	1,800 - 5,500	0.0225 - 0.0687	1.500	0.250
6	R 3.0	20,000	1,800 - 5,500	0.0225 - 0.0687	0.300	1.800	1,800 - 5,500	0.0225 - 0.0687	1.800	0.300
8	R 4.0	15,000	2,200 - 5,000	0.0366 - 0.0833	0.400	2.400	2,200 - 5,000	0.0366 - 0.0833	2.400	0.400
10	R 5.0	12,000	2,300 - 4,600	0.0479 - 0.0958	0.500	3.000	2,300 - 4,600	0.0479 - 0.0958	3.000	0.500
12	R 6.0	10,000	1,900 - 4,100	0.0475 - 0.1025	0.600	3.600	1,900 - 4,100	0.0475 - 0.1025	3.600	0.600
16	R 8.0	7,500	1,600 - 3,200	0.0533 - 0.1066	0.800	4.800	1,600 - 3,200	0.0533 - 0.1066	4.800	0.800

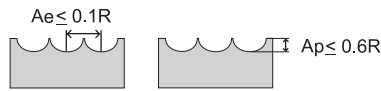

Cooling Requirements - High Pressure Air Blast

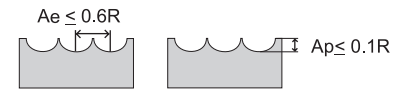

Cooling Requirements - High Pressure Air Blast.

Titanium

Diameter	R	RPM	f	fz
mm	mm	trs	mm/min	mm/z
1.5	R 0.75	32,000	2,700	0.020
2.0	R 1.0	24,000	2,400	0.025
2.5	R 1.25	24,000	2,400	0.025
3.0	R 1.5	16,000	1,950	0.030
3.5	R 1.75	16,000	1,950	0.030
4.0	R 2.0	12,000	1,950	0.040
4.5	R 2.25	12,000	1,950	0.040
5.0	R 2.5	10,000	1,650	0.040
6.0	R 3.0	8,000	1,500	0.046
8.0	R 4.0	6,000	1,650	0.068
10.0	R 5.0	5,000	1,650	0.080
12.0	R 6.0	4,000	1,500	0.093
16.0	R 8.0	3,000	1,200	0.100

High Temperature Alloys

Diameter	R	RPM	f	fz	Ae Max.	Ap Max.
mm	mm	trs	mm/min	mm/z	mm	mm
1.5	R 0.75	10,000	825	0.020	0.075	0.05
2.0	R 1.0	7,300	750	0.025	0.100	0.06
2.5	R 1.25	6,000	700	0.029	0.125	0.08
3.0	R 1.5	5,000	630	0.030	0.150	0.09
3.5	R 1.75	4,100	575	0.035	0.175	0.11
4.0	R 2.0	3,600	555	0.040	0.200	0.12
4.5	R 2.25	3,200	510	0.040	0.220	0.14
5.0	R 2.5	3,000	510	0.040	0.250	0.15
6.0	R 3.0	2,500	495	0.046	0.300	0.18
8.0	R 4.0	1,900	510	0.068	0.400	0.24
10.0	R 5.0	1,500	510	0.080	0.500	0.30
12.0	R 6.0	1,200	450	0.093	0.600	0.36
16.0	R 8.0	900	360	0.100	0.800	0.48

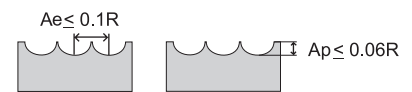

Cooling Requirements - Maximum coolant flow/pressure

TuffCut® XR7 Series 180

Recommended cutting data · Conditions de coupe recommandées · Empfohlene Schnittdaten · Dati di taglio Raccomandati · Zalecane Parametry

Workpiece Material Group	Material Type	Coolant			0.05 x D 2 x D	0.1 x D 2 x D	0.2 x D 2 x D	
		Max	Air	MMS	Vc-M/Min			
Steels	P	Low Carbon	●	●	●	480	385	330
		Medium Carbon	●	●	●	345	275	255
		Alloy Steels	●	●	●	315	255	230
		Die/Tool Steels	●	●	●	275	220	187
Stainless Steels	M	Free Machining	●	X	○	205	165	130
		Austenitic	●	X	○	160	130	120
		Difficult Stainless	●	X	○	125	100	90
		PH Stainless	●	X	○	160	130	120
		Cobalt Chrome Alloys	●	X	○	125	100	90
		Duplex (22%)	●	X	○	125	100	90
		Super Duplex (25%)	●	X	○	75	60	55
Special Alloys	S	High Temp Alloys	●	X	X	55	45	40
		Inconel	●	X	X	55	45	40
		Titanium Alloys	●	X	X	160	130	100
Cast Irons	K	Gray Cast Iron	●	○	○	495	395	265
		Ductile Cast Iron	●	○	○	370	300	210
		Malleable Iron	●	○	○	205	165	155
Hardened Steels	H	Hardened Steels 45 - 50 Rc	●	○	○	185	150	100
		Hardened Steels 50 - 55 Rc	I	○	○	155	125	85

● Preferred ○ Possible X Not Possible

Workpiece Material Group	Material Type	Tool Diameter						
		6mm	8mm	10mm	12mm	16mm	20mm	
fz-mm/tooth								
Steels	P	Low Carbon	0.036	0.048	0.060	0.072	0.096	0.120
		Medium Carbon	0.036	0.048	0.060	0.072	0.096	0.120
		Alloy Steels	0.036	0.048	0.060	0.072	0.096	0.120
		Die/Tool Steels	0.036	0.048	0.060	0.072	0.096	0.120
Stainless Steels	M	Free Machining	0.036	0.048	0.060	0.072	0.096	0.12
		Austenitic	0.029	0.038	0.048	0.058	0.077	0.096
		Difficult Stainless	0.024	0.032	0.040	0.048	0.064	0.080
		PH Stainless	0.029	0.038	0.048	0.058	0.077	0.096
		Cobalt Chrome Alloys	0.018	0.024	0.030	0.036	0.048	0.060
		Duplex (22%)	0.018	0.024	0.030	0.036	0.048	0.060
		Super Duplex (25%)	0.018	0.024	0.030	0.036	0.048	0.060
Special Alloys	S	High Temp Alloys	0.014	0.019	0.024	0.029	0.038	0.048
		Inconel	0.014	0.019	0.024	0.029	0.038	0.048
		Titanium Alloys	0.024	0.032	0.040	0.048	0.064	0.08
Cast Irons	K	Gray Cast Iron	0.032	0.043	0.054	0.065	0.086	0.108
		Ductile Cast Iron	0.032	0.043	0.054	0.065	0.086	0.108
		Malleable Iron	0.028	0.037	0.046	0.055	0.074	0.092
Hardened Steels	H	Hardened Steels 45 - 50 Rc	0.025	0.034	0.042	0.050	0.067	0.084
		Hardened Steels 50 - 55 Rc	0.022	0.029	0.036	0.043	0.058	0.072

Please Note - Peripheral Milling only.

During profile milling less than 50% of the cutter diameter radial width, the actual chip thickness at the cutting edge is less than the programmed chipload. The accompanying table shows the increase in tooth load by given radial percentage engagement. Multiply your feed per tooth by the factor before finalising your table feed.

Radial Cut (Ae)	Chip thickness Compensation factor
15%	1.40
13%	1.50
10%	1.67
8%	1.80
7%	2.00
5%	2.30

TuffCut® XT9 Series 380

Recommended cutting data | Conditions de coupe recommandées | Empfohlene Schnittdaten | Dati di taglio Raccomandati | Zalecane Parametry

Workpiece Material Group	ISO	Hardness	Coolant			Profiling (ae)		End Mill Diameter (mm)				
			● Preferred ○ Possible x Not Possible					8	10	12	16	20
						5%	10%	← Multiply fz by this Factor based on ae. When finishing, use the standard fz per chart below. Only add chip thinning when roughing or semi-finishing.				
			Max.	Air	MMS	vc - m/min	fz - mm/tooth					
Low Carbon Steels 1018, 1020	P	up to 28 Rc	●	●	●	450	350	.080	.100	.110	.150	.254
Medium Carbon Steels 1140, 1145	P	28 to 38 Rc	●	●	●	345	275	.080	.100	.110	.150	.254
Alloy Steels 4140, 4145	P	28 to 44 Rc	●	●	●	315	255	.080	.100	.110	.150	.254
Die / Tool Steels A2, D2, H13, P20	P	28 to 44 Rc	●	●	●	275	220	.080	.100	.110	.150	.254
Stainless Steel - Easy to Machine 430F, 301, 303, 410, 416 Annealed, 420F, 430	M	up to 28 Rc	●	x	○	205	165	.030-.040	.038-.050	.050-.078	.050-.083	.060-.099
Stainless Steel - Austenitic 301, 302, 303 High Tensile, 304, 304L, 305, 420, 15-5PH, 17-4PH, 17-7PH	M	up to 28 Rc	●	x	○	160	130	.030-.040	.038-.050	.050-.078	.050-.083	.060-.099
Stainless Steel - Difficult to Machine 302B, 304B, 309, 310, 316, 316B, 316L, 316Ti, 317, 317L, 321	M	up to 28 Rc	●	x	○	125	100	.030-.040	.038-.050	.050-.078	.050-.083	.060-.099
Stainless Steel - Difficult to Machine 17-4 PH, PH13-8Mo, Nitronics	M	over 28 Rc	●	x	○	160	130	.030-.040	.038-.050	.050-.078	.050-.083	.060-.099
Cobalt Chrome Alloys	M		●	x	○	125	100	.040	.050	.078	.083	.099
Duplex (22%)	M		●	x	○	75	60	.040	.050	.078	.083	.099
Super Duplex (25%)	M		●	x	○	75	60	.040	.050	.078	.083	.099
High Temp Alloys	S	up to 42 Rc	●	x	x	55	45	.030-.040	.038-.050	.025-.040	.025-.043	.030-.050
Inconel	S		●	x	x	55	45	.020-.030	.025-.040	.025-.040	.025-.043	.030-.050
Titanium Alloys 6Al-4V, 5Al-2.5 Sn, 6Al-2 Sn-4Zr-6Mo, 3Al-8V-6Cr-4Mo-4Zr, 10V-2Fe-3Al, 13V-11Cr-3Al	S	up to 42 Rc	●	x	x	115	105	.020-.030	.025-.040	.050-.078	.050-.083	.030-.050
Cast-Iron - Gray CG, ASTM A48, CLASS 20, 25, 30, 35, SAE J431C, GRADES G1800, G3000, G3500, GG 10, 15, 20, 25, 30, 35, 40	K	up to 240 HB	●	○	○	495	395	.080	.100	.110	.150	.254
Cast Iron - Ductile & Malleable CGI 60-40-18, 65-45-12, D4018, D4512, D5506, 32510, 35108, M3210, M4504, M5503, 250, 300, 350, 400, 450	K	over 240 HB	●	○	○	205	165	.065	.080	.110	.150	.254
Hardened Steels	H	40-50 Rc	●	○	○	185	150	.050	.060	.101	.116	.152
Hardened Steels		50-55 Rc	●	○	○	155	125	.030	.040	.061	.076	.088
Hardened Steels		>55 Rc	●	○	○	100	95	.020	.025	.045	.055	.063

Safety Note

Always wear the appropriate personal protective equipment such as safety glasses and protective clothing when using solid carbide or HSS cutting tools. Machines should be fully guarded.

Spindle Maximum - Should the calculated spindle speed be more than your actual spindle maximum, use this formula:
 $(\text{Calculated Feed} \times \text{Spindle Maximum}) / \text{Calculated Speed}$

Technical data provided should be considered advisory only as variations may be necessary depending on the particular application.

TuffCut® XT Series 279, 277 / R / NR / NR-W, 278 R / N3 / N4 / N5

Recommended cutting data Conditions de coupe recommandées · Empfohlene Schnittdaten · Dati di taglio Raccomandati · Zalecane Parametry

Workpiece Material Group	Material Type	Coolant			1 x D	1 x D	0.05 x D	0.1 x D	0.2 x D	0.3 x D	0.5 x D	
		Max	Air	MMS	0.5 x D	1 x D	2 x D	2 x D	2 x D	1.5 x D	1.5 x D	
Vc-M/Min												
Steels	P	Low Carbon	●	●	●	230	220	480	385	330	275	220
		Medium Carbon	●	●	●	200	185	345	275	255	220	185
		Alloy Steels	●	●	●	175	165	315	255	230	200	165
		Die/Tool Steels	●	●	●	145	130	275	220	187	145	130
Stainless Steels	M	Free Machining	●	X	○	120	110	205	165	130	115	110
		Austenitic	●	X	○	110	100	160	130	120	110	100
		Difficult Stainless	●	X	○	75	65	125	100	90	75	65
		PH Stainless	●	X	○	110	100	160	130	120	110	100
		Cobalt Chrome Alloys	●	X	○	75	65	125	100	90	75	65
		Duplex (22%)	●	X	○	75	65	125	100	90	75	65
Special Alloys	S	Super Duplex (25%)	●	X	○	55	45	75	60	55	50	45
		High Temp Alloys	●	X	X	35	28	55	45	40	35	28
Cast Irons	K	Gray Cast Iron	●	○	○	200	175	495	395	265	210	175
		Ductile Cast Iron	●	○	○	185	165	370	300	210	185	165
		Malleable Iron	●	○	○	145	132	205	165	155	145	130
Hardened Steels	H	Hardened Steels 35 - 45 Rc	●	○	○	60	50	185	150	100	55	50
		Hardened Steels 45 - 55 Rc	●	○	○	50	45	155	125	85	50	45

● Preferred ○ Possible X Not Possible

Workpiece Material Group	Material Type	Tool Diameter									
		3mm	5mm	6mm	8mm	10mm	12mm	16mm	20mm	25mm	
		fz-mm/tooth									
Steels	P	Profiling	0.030	0.050	0.06	0.080	0.100	0.120	0.160	0.200	0.250
		Slotting	0.015	0.025	0.03	0.040	0.050	0.060	0.080	0.100	0.125
Stainless Steels	M	Profiling	0.030	0.050	0.06	0.080	0.100	0.120	0.160	0.200	0.250
		Slotting	0.015	0.025	0.03	0.040	0.050	0.060	0.080	0.100	0.125
Special Alloys	S	Profiling	0.009	0.013	0.032	0.038	0.044	0.064	0.076	0.089	0.127
		Slotting	0.005	0.007	0.016	0.019	0.022	0.032	0.038	0.045	0.065
Titanium	S	Profiling	0.030	0.050	0.060	0.080	0.100	0.120	0.160	0.200	0.250
		Slotting	0.015	0.025	0.030	0.040	0.050	0.060	0.080	0.100	0.125
Cast Irons	K	Profiling	0.030	0.050	0.060	0.080	0.100	0.120	0.160	0.200	0.250
		Slotting	0.015	0.025	0.030	0.040	0.050	0.060	0.080	0.100	0.125
Hardened Steels	H	Profiling 35 - 45 Rc	0.016	0.023	0.057	0.069	0.080	0.114	0.137	0.160	0.229
		Slotting 35 - 45 Rc	0.010	0.015	0.025	0.035	0.045	0.065	0.070	0.075	0.100
		Profiling 45 - 55 Rc	0.010	0.015	0.041	0.051	0.058	0.084	0.102	0.119	0.170
		Slotting 45 - 55 Rc	0.008	0.011	0.020	0.030	0.040	0.050	0.055	0.080	0.090

During profile milling less than 50% of the cutter diameter radial width, the actual chip thickness at the cutting edge is less than the programmed chipload. The accompanying table shows the increase in tooth load by given radial percentage engagement. Multiply your feed per tooth by the factor before finalising your table feed.

Radial Cut (Ae)	Chip thickness Compensation factor
30%	1.10
20%	1.20
15%	1.40
10%	1.80
7%	2.00
5%	2.30
1%	5.00

Note:

For N4 tools reduce above data by 10%

For N5 tools reduce above data by 30%

For N4 & N5 tools profile machining only!

TuffCut® XT Series V5LCB

Recommended cutting data | Conditions de coupe recommandées | Empfohlene Schnittdaten | Dati di taglio Raccomandati | Zalecane Parametry

3 x D Cutting Length			Ø 6.0	Ø 8.0	Ø 10.0	Ø 12.0	Ø 16.0
			Maximum Axial Depth Of Cut (ap)	Maximum Axial Depth Of Cut (ap)	Maximum Axial Depth Of Cut (ap)	Maximum Axial Depth Of Cut (ap)	Maximum Axial Depth Of Cut (ap)
			≤ 3 x ØD (18.0mm)	≤ 3 x ØD (24.0mm)	≤ 3 x ØD (30.0mm)	≤ 3 x ØD (36.0mm)	≤ 3 x ØD (48.0mm)
Material Group	Vc		Maximum Radial Depth Of Cut (ae)	Maximum Radial Depth Of Cut (ae)	Maximum Radial Depth Of Cut (ae)	Maximum Radial Depth Of Cut (ae)	Maximum Radial Depth Of Cut (ae)
			0.1 x ØD ₁ (0.6mm)	0.1 x ØD ₁ (0.8mm)	0.1 x ØD ₁ (1.0mm)	0.1 x ØD ₁ (1.2mm)	0.1 x ØD ₁ (1.6mm)
Low Carbon, Free Machining Steels	300	RPM	15,900	11,925	9,540	7,950	5,963
		Feed (Vf)	5,724	5,724	5,724	5,724	5,724
Alloy Steels, Tool Steels & Nitriding Steels	200	RPM	10,600	7,950	6,360	5,300	3,975
		Feed (Vf)	3,816	3,816	3,816	3,816	3,816
Free Machining & Austenitic Stainless Steels ≤ 32 HRC	150	RPM	7,950	5,963	4,770	3,975	2,981
		Feed (Vf)	2,862	2,862	2,862	2,862	2,862
Moderate Machining & PH Stainless Steels	130	RPM	6,890	5,168	4,134	3,445	2,584
		Feed (Vf)	2,480	2,480	2,480	2,480	2,480
Duplex & Super Duplex Stainless Steels	80	RPM	4,240	3,180	2,544	2,120	1,590
		Feed (Vf)	1,526	1,526	1,526	1,526	1,526
Titanium Alloys	80	RPM	4,240	3,180	2,544	2,120	1,590
		Feed (Vf)	1,526	1,526	1,526	1,526	1,526

4 x D Cutting Length			Ø 6.0	Ø 8.0	Ø 10.0	Ø 12.0	Ø 16.0
			Maximum Axial Depth Of Cut (ap)	Maximum Axial Depth Of Cut (ap)	Maximum Axial Depth Of Cut (ap)	Maximum Axial Depth Of Cut (ap)	Maximum Axial Depth Of Cut (ap)
			≤ 4 x ØD (24.0mm)	≤ 4 x ØD (32.0mm)	≤ 4 x ØD (40.0mm)	≤ 4 x ØD (48.0mm)	≤ 4 x ØD (64.0mm)
Material Group	Vc		Maximum Radial Depth Of Cut (ae)	Maximum Radial Depth Of Cut (ae)	Maximum Radial Depth Of Cut (ae)	Maximum Radial Depth Of Cut (ae)	Maximum Radial Depth Of Cut (ae)
			0.05 x ØD (0.3mm)	0.05 x ØD (0.4mm)	0.05 x ØD (0.5mm)	0.05 x ØD (0.6mm)	0.05 x ØD (0.8mm)
Low Carbon, Free Machining Steels	300	RPM	15,900	11,925	9,540	7,950	5,963
		Feed (Vf)	5,724	5,724	5,724	5,724	5,724
Alloy Steels, Tool Steels & Nitriding Steels	200	RPM	10,600	7,950	6,360	5,300	3,975
		Feed (Vf)	3,816	3,816	3,816	3,816	3,816
Free Machining & Austenitic Stainless Steels ≤ 32 HRC	150	RPM	7,950	5,963	4,770	3,975	2,981
		Feed (Vf)	2,862	2,862	2,862	2,862	2,862
Moderate Machining & PH Stainless Steels	130	RPM	6,890	5,168	4,134	3,445	2,584
		Feed (Vf)	2,480	2,480	2,480	2,480	2,480
Duplex & Super Duplex Stainless Steels	80	RPM	4,240	3,180	2,544	2,120	1,590
		Feed (Vf)	1,526	1,526	1,526	1,526	1,526
Titanium Alloys	80	RPM	4,240	3,180	2,544	2,120	1,590
		Feed (Vf)	1,526	1,526	1,526	1,526	1,526

Please note - the cutting data shown in the table above is advisory and should be considered as the maximum. Adjustments should be made to the cutting data depending on the application, work piece rigidity, machine tool etc. V5LCB should only be used in accurate tool holders with high gripping power. ER collet type tool holders are not recommended.

TuffCut® Series 158

Recommended cutting data · Conditions de coupe recommandées · Empfohlene Schnittdaten · Dati di taglio Raccomandati · Zalecane Parametry

HSC Roughing

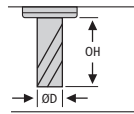

Workpiece Material Group	Material Type	Coolant		OH	Vc	Tool Diameter and Corner Radius								
		Air	Emulsion			2.0 x R0.5			3.0 x R0.8			4.0 x R1.0		
						Ap	Ae	Fz	Ap	Ae	Fz	Ap	Ae	Fz
Steel	Alloy & Tool Steel Below 260HB	●	○	3D	120	0.10	0.5	0.10	0.16	0.7	0.16	0.20	1.0	0.20
				4D	110	0.09		0.10	0.14		0.16	0.18		0.20
				5D	100	0.09		0.10	0.14		0.16	0.17		0.20
				6D	95	0.07		0.10	0.11		0.16	0.14		0.20
				8D	85	0.06		0.10	0.10		0.16	0.12		0.20
	10D	70	0.05	0.10	0.08	0.16	0.10	0.20						
	Pre-hardened Tool Steel HRC30-40	●	○	3D	95	0.08	0.5	0.09	0.13	0.7	0.14	0.16	1.0	0.18
				4D	85	0.07		0.09	0.12		0.14	0.14		0.18
				5D	80	0.07		0.09	0.11		0.14	0.14		0.18
				6D	75	0.05		0.09	0.09		0.14	0.11		0.18
8D				65	0.05	0.09		0.08	0.14		0.10	0.18		
10D	55	0.04	0.09	0.06	0.14	0.08	0.18							
Stainless Steel	Stainless Steel 300 & PH series	x	●	3D	70	0.08	0.5	0.09	0.13	0.7	0.14	0.16	1.0	0.18
				4D	65	0.07		0.09	0.12		0.14	0.14		0.18
				5D	60	0.07		0.09	0.11		0.14	0.14		0.18
				6D	55	0.05		0.09	0.09		0.14	0.11		0.18
				8D	50	0.05		0.09	0.08		0.14	0.10		0.18
10D	40	0.04	0.09	0.06	0.14	0.08	0.18							
Special Alloys	High Temp Alloys	x	●	3D	30	0.03	0.4	0.05	0.04	0.6	0.08	0.05	0.8	0.10
				4D	25	0.02		0.05	0.04		0.08	0.05		0.10
				5D	25	0.02		0.05	0.03		0.08	0.04		0.10
				6D	25	0.02		0.05	0.03		0.08	0.03		0.10
				8D	20	0.02		0.05	0.02		0.08	0.03		0.10
	10D	20	0.01	0.05	0.02	0.08	0.03	0.10						
	Titanium Alloys	x	●	3D	70	0.06	0.4	0.08	0.09	0.6	0.12	0.11	0.8	0.15
				4D	65	0.05		0.08	0.08		0.12	0.10		0.15
				5D	60	0.05		0.08	0.07		0.12	0.09		0.15
				6D	55	0.04		0.08	0.06		0.12	0.07		0.15
8D				50	0.03	0.08		0.05	0.12		0.07	0.15		
10D	40	0.03	0.08	0.04	0.12	0.06	0.15							
Cast Iron	GG, GGG	●	●	3D	120	0.10	0.5	0.10	0.16	0.7	0.16	0.20	1.0	0.20
				4D	110	0.09		0.10	0.14		0.16	0.18		0.20
				5D	100	0.09		0.10	0.14		0.16	0.17		0.20
				6D	95	0.07		0.10	0.11		0.16	0.14		0.20
				8D	85	0.06		0.10	0.10		0.16	0.12		0.20
10D	70	0.05	0.10	0.08	0.16	0.10	0.20							
Hardened Steels	Hardened Steels HRC45-50	●	○	3D	80	0.06	0.5	0.07	0.10	0.7	0.11	0.12	1.0	0.14
				4D	70	0.05		0.07	0.09		0.11	0.11		0.14
				5D	70	0.05		0.07	0.08		0.11	0.10		0.14
				6D	65	0.04		0.07	0.07		0.11	0.08		0.14
				8D	55	0.04		0.07	0.06		0.11	0.07		0.14
	10D	50	0.03	0.07	0.05	0.11	0.06	0.14						
	Hardened Steels HRC50-55	●	x	3D	60	0.05	0.4	0.05	0.08	0.6	0.08	0.10	0.8	0.10
				4D	55	0.05		0.05	0.07		0.08	0.09		0.10
				5D	50	0.04		0.05	0.07		0.08	0.09		0.10
				6D	50	0.03		0.05	0.05		0.08	0.07		0.10
8D				40	0.03	0.05		0.05	0.08		0.06	0.10		
10D	35	0.03	0.05	0.04	0.08	0.05	0.10							

● Preferred ○ Possible X Not Possible

TuffCut® Series 158

Recommended cutting data | Conditions de coupe recommandées | Empfohlene Schnittdaten | Dati di taglio Raccomandati | Zalecane Parametry

HSC Roughing





Tool Diameter and Corner Radius														
6.0 x R1.5			8.0 x R2.0			10.0 x R2.0			12 x R2.0			16 x R3.0		
Ap	Ae	Fz	Ap	Ae	Fz	Ap	Ae	Fz	Ap	Ae	Fz	Ap	Ae	Fz
0.30	1.5	0.30	0.40	2.0	0.4	0.40	3.0	0.40	0.40	4.0	0.40	0.60	5.0	0.6
0.27		0.30	0.36		0.4	0.36		0.40	0.36		0.40	0.54		0.6
0.26		0.30	0.34		0.4	0.34		0.40	0.34		0.40	0.51		0.6
0.20		0.30	0.27		0.4	0.27		0.40	0.27		0.40	0.41		0.6
0.18		0.30	0.24		0.4	0.24		0.40	0.24		0.40	0.36		0.6
0.15		0.30	0.20		0.4	0.20		0.40	0.20		0.40	0.30		0.6
0.24	1.5	0.27	0.32	2.0	0.36	0.32	3.0	0.36	0.32	4.0	0.36	0.48	5.0	0.54
0.22		0.27	0.29		0.36	0.29		0.36	0.29		0.36	0.43		0.54
0.20		0.27	0.27		0.36	0.27		0.36	0.27		0.36	0.41		0.54
0.16		0.27	0.22		0.36	0.22		0.36	0.22		0.36	0.33		0.54
0.14		0.27	0.19		0.36	0.19		0.36	0.19		0.36	0.29		0.54
0.12		0.27	0.16		0.36	0.16		0.36	0.16		0.36	1.28		0.54
0.24	1.5	0.27	0.32	2.0	0.36	0.32	3.0	0.36	0.32	4.0	0.36	0.48	5.0	0.54
0.22		0.27	0.29		0.36	0.29		0.36	0.29		0.36	0.43		0.54
0.20		0.27	0.27		0.36	0.27		0.36	0.27		0.36	0.41		0.54
0.16		0.27	0.22		0.36	0.22		0.36	0.22		0.36	0.33		0.54
0.14		0.27	0.19		0.36	0.19		0.36	0.19		0.36	0.29		0.54
0.12		0.27	0.16		0.36	0.16		0.36	0.16		0.36	1.28		0.54
0.08	1.2	0.15	0.10	1.6	0.20	0.10	2.5	0.20	0.10	3.5	0.20	0.15	4.3	0.30
0.07		0.15	0.09		0.20	0.09		0.20	0.09		0.20	0.14		0.30
0.06		0.15	0.09		0.20	0.09		0.20	0.09		0.20	0.13		0.30
0.05		0.15	0.07		0.20	0.07		0.20	0.07		0.20	0.10		0.30
0.05		0.15	0.06		0.20	0.06		0.20	0.06		0.20	0.09		0.30
0.04		0.15	0.05		0.20	0.05		0.20	0.05		0.20	0.08		0.30
0.17	1.2	0.23	0.22	1.6	0.30	0.22	2.5	0.30	0.22	3.5	0.30	0.33	4.3	0.45
0.15		0.23	0.20		0.30	0.20		0.30	0.20		0.30	0.30		0.45
0.14		0.23	0.19		0.30	0.19		0.30	0.19		0.30	0.28		0.45
0.11		0.23	0.15		0.30	0.15		0.30	0.15		0.30	0.22		0.45
0.10		0.23	0.13		0.30	0.13		0.30	0.13		0.30	0.20		0.45
0.08		0.23	0.11		0.30	0.11		0.30	0.11		0.30	0.17		0.45
0.30	1.5	0.30	0.40	2.0	0.4	0.40	3.0	0.40	0.40	4.0	0.40	0.60	5.0	0.6
0.27		0.30	0.36		0.4	0.36		0.40	0.36		0.40	0.54		0.6
0.26		0.30	0.34		0.4	0.34		0.40	0.34		0.40	0.51		0.6
0.20		0.30	0.27		0.4	0.27		0.40	0.27		0.40	0.41		0.6
0.18		0.30	0.24		0.4	0.24		0.40	0.24		0.40	0.36		0.6
0.15		0.30	0.20		0.4	0.20		0.40	0.20		0.40	0.30		0.6
0.18	1.5	0.21	0.24	2.0	0.28	0.24	3.0	0.28	0.24	4.0	0.28	0.36	5.0	0.42
0.16		0.21	0.22		0.28	0.22		0.28	0.22		0.28	0.32		0.42
0.15		0.21	0.20		0.28	0.20		0.28	0.20		0.28	0.31		0.42
0.12		0.21	0.16		0.28	0.16		0.28	0.16		0.28	0.24		0.42
0.11		0.21	0.14		0.28	0.14		0.28	0.14		0.28	0.22		0.42
0.09		0.21	0.12		0.28	0.12		0.28	0.12		0.28	0.18		0.42
0.15	1.2	0.15	0.20	1.6	0.20	0.20	2.5	0.20	0.20	3.5	0.20	0.30	4.3	0.30
0.14		0.15	0.18		0.20	0.18		0.20	0.18		0.20	0.27		0.30
0.13		0.15	0.17		0.20	0.17		0.20	0.17		0.20	0.26		0.30
0.10		0.15	0.14		0.20	0.14		0.20	0.14		0.20	0.20		0.30
0.09		0.15	0.12		0.20	0.12		0.20	0.12		0.20	0.18		0.30
0.08		0.15	0.10		0.20	0.10		0.20	0.10		0.20	0.15		0.30

TuffCut® Series 158

Recommended cutting data · Conditions de coupe recommandées · Empfohlene Schnittdaten · Dati di taglio Raccomandati · Zalecane Parametry

Cutting Speed

Workpiece Material Group	Material Type	Coolant					
		Air	Emulsion	Slotting	Profiling	2D/3D HSC	
		Vc-M/Min					
Steels	P	Alloy & Tool Steels Below 260HB	●	○	100	180	200
		Pre-hardened Tools Steel HRC30-40	●	●	70	120	180
Stainless Steels	M	Stainless Steels 300 & PH series	X	●	80	100	150
Special Alloys	S	High Temp Alloys	X	●	25	50	70
		Titanium Alloys	X	●	60	100	120
Cast Irons	K	GG, GGG	●	●	100	200	220
Hardened Steels	H	Hardened Steels HRC45-50	●	○	75	90	140
		Hardened Steels HRC50-55	●	○	40	70	120

● Preferred ○ Possible X Not Possible

Feed Per Tooth

Workpiece Material Group	Material Type	Operation	Tool Diameter								
			2.0	3.0	4.0	6.0	8.0	10.0	12.0	16.0	
			fz-mm/tooth								
Steels	P	Alloy & Tool Steels Below 260HB	Slotting	0.010	0.015	0.020	0.030	0.040	0.050	0.060	0.080
			Profiling	0.020	0.030	0.040	0.060	0.080	0.100	0.120	0.160
			HSC 2D/3D	0.060	0.090	0.120	0.180	0.240	0.300	0.360	0.480
	Pre-hardened Tool Steels HRC30-40	Slotting	0.008	0.012	0.016	0.024	0.032	0.040	0.048	0.064	
		Profiling	0.016	0.024	0.032	0.048	0.064	0.080	0.096	0.128	
		HSC 2D/3D	0.050	0.075	0.100	0.150	0.200	0.250	0.300	0.400	
Stainless Steels	M	Stainless Steel 300 & PH series	Slotting	0.007	0.010	0.013	0.020	0.026	0.033	0.040	0.053
			Profiling	0.013	0.020	0.026	0.040	0.053	0.066	0.079	0.106
			HSC 2D/3D	0.040	0.060	0.080	0.120	0.160	0.200	0.240	0.320
Special Alloys	S	High Temp Alloys	Slotting	0.004	0.006	0.008	0.013	0.017	0.021	0.025	0.034
			Profiling	0.008	0.013	0.017	0.025	0.034	0.042	0.050	0.067
			HSC 2D/3D	0.020	0.030	0.040	0.060	0.080	0.100	0.120	0.160
	Titanium Alloys	Slotting	0.006	0.009	0.012	0.018	0.024	0.030	0.036	0.048	
		Profiling	0.012	0.018	0.024	0.036	0.048	0.060	0.072	0.096	
		HSC 2D/3D	0.040	0.060	0.080	0.120	0.160	0.200	0.240	0.320	
Cast Irons	K	GG, GGG	Slotting	0.010	0.015	0.020	0.030	0.040	0.050	0.060	0.080
			Profiling	0.020	0.030	0.040	0.060	0.080	0.100	0.120	0.160
			HSC 2D/3D	0.060	0.090	0.120	0.180	0.240	0.300	0.360	0.480
Hardened Steels	H	Hardened Steels HRC45-50	Slotting	0.007	0.010	0.013	0.020	0.026	0.033	0.040	0.053
			Profiling	0.013	0.020	0.026	0.040	0.053	0.066	0.079	0.106
			HSC 2D/3D	0.040	0.060	0.080	0.120	0.160	0.200	0.240	0.320
	Hardened Steels HRC50-55	Slotting	0.005	0.008	0.010	0.015	0.020	0.025	0.030	0.040	
		Profiling	0.010	0.015	0.020	0.030	0.040	0.050	0.060	0.080	
		HSC 2D/3D	0.030	0.045	0.060	0.090	0.120	0.150	0.180	0.240	

TuffCut® Series 158

Recommended cutting data | Conditions de coupe recommandées | Empfohlene Schnittdaten | Dati di taglio Raccomandati | Zalecane Parametry

Depth of Cut HSC 2D/3D Axial & Radial

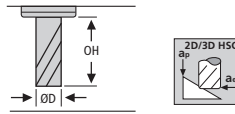

Workpiece Material Group	Material Type	OH	Tool Diameter							
			2.0	3.0	4.0	6.0	8.0	10.0	12.0	16.0
			Ap-mm / Ae-mm							
Steels	Alloy & Tool Steels Below 260HB	3D-4D	0.06	0.09	0.12	0.18	0.24	0.30	0.36	0.48
		5D-6D	0.05	0.07	0.10	0.14	0.19	0.24	0.29	0.38
		8D-10D	0.04	0.05	0.07	0.11	0.14	0.18	0.22	0.29
	Pre-hardened Tool Steels HRC30-40	3D-4D	0.06	0.09	0.12	0.18	0.24	0.30	0.36	0.48
		5D-6D	0.05	0.07	0.10	0.14	0.19	0.24	0.29	0.38
		8D-10D	0.04	0.05	0.07	0.11	0.14	0.18	0.22	0.29
Stainless Steels	Stainless Steel 300 & PH series	3D-4D	0.06	0.09	0.12	0.18	0.24	0.30	0.36	0.48
		5D-6D	0.05	0.07	0.10	0.14	0.19	0.24	0.29	0.38
		8D-10D	0.04	0.05	0.07	0.11	0.14	0.18	0.22	0.29
Special Alloys	High Temp Alloys	3D-4D	0.04	0.06	0.08	0.12	0.16	0.20	0.24	0.32
		5D-6D	0.03	0.05	0.06	0.10	0.13	0.16	0.19	0.26
		8D-10D	0.02	0.04	0.05	0.07	0.10	0.12	0.14	0.19
	Titanium Alloys	3D-4D	0.06	0.09	0.12	0.18	0.24	0.30	0.36	0.48
		5D-6D	0.05	0.07	0.10	0.14	0.19	0.24	0.29	0.38
		8D-10D	0.04	0.05	0.07	0.11	0.14	0.18	0.22	0.29
Cast Irons	GG, GGG	3D-4D	0.06	0.09	0.12	0.18	0.24	0.30	0.36	0.48
		5D-6D	0.05	0.07	0.10	0.14	0.19	0.24	0.29	0.38
		8D-10D	0.04	0.05	0.07	0.11	0.14	0.18	0.22	0.29
Hardened Steels	Hardened Steels HRC45-50	3D-4D	0.05	0.08	0.10	0.15	0.20	0.25	0.30	0.40
		5D-6D	0.04	0.06	0.08	0.12	0.16	0.20	0.24	0.32
		8D-10D	0.03	0.05	0.06	0.09	0.12	0.15	0.18	0.24
	Hardened Steels HRC50-55	3D-4D	0.04	0.06	0.08	0.12	0.16	0.20	0.24	0.32
		5D-6D	0.03	0.05	0.06	0.10	0.13	0.16	0.19	0.26
		8D-10D	0.02	0.04	0.05	0.07	0.10	0.12	0.14	0.19

Notes:

For profile machining
adjust radial cut (Ae)

OH	Ae (x Ø)
3D-4D	0.1
5D-6D	0.07
8D-10D	0.05



Radial Cut (Ae)	Chip thickness Compensation factor
30%	1.10
20%	1.20
15%	1.40
10%	1.80
5%	2.30
1%	5.00

For slotting
adjust axial cut (Ap)

OH	Ap (x Ø)
3D-4D	0.1
5D-6D	0.07
8D-10D	0.05

TuffCut® XT Series MFB

Recommended cutting data :: Conditions de coupe recommandées :: Empfohlene Schnittdaten :: Dati di taglio Raccomandati :: Zalecane Parametry

Recommended Speeds by Material Group						Finishing	Semi-Finishing
Workpiece Material Group	Material Type		Ap			0.01-0.03 x D	0.05-0.1 x D
			Ae			0.02-0.03 x D	0.05-0.1 x D
			Coolant			Vc-M/Min	
			Max	Air	MMS		
Steels	P	Low Carbon	●	●	●	450	350
		Medium Carbon	●	●	●	345	275
		Alloy Steels	●	●	●	315	255
		Die/Tool Steels	●	●	●	275	220
Stainless Steels	M	Free Machining	●	X	○	205	165
		Austenitic	●	X	○	160	130
		Difficult Stainless	●	X	○	125	100
		PH Stainless	●	X	○	160	130
		Cobalt Chrome Alloys	●	X	○	125	100
		Duplex (22%)	●	X	○	75	60
		Super Duplex (25%)	●	X	○	75	60
Special Alloys	S	High Temp Alloys	●	X	X	55	45
		Titanium Alloys	●	X	X	115	105
Cast Irons	K	Gray Cast Iron	●	○	○	495	395
		Ductile Cast Iron	●	○	○	320	280
		Malleable Iron	●	○	○	205	165
Hardened Steels	H	Hardened Steels 45 - 50 Rc	●	○	○	150	125
		Hardened Steels 50 - 55 Rc	●	○	○	100	95

● Preferred ○ Possible X Not Possible

Recommended Feeds by Material Group			Tool Diameter & Radius															
Workpiece Material Group	Material Type		4		5		6		8		10		12		16		20	
			2		2.5		3		4		5		6		8		10	
			Semi Finish	Finish	Semi Finish	Finish	Semi Finish	Finish	Semi Finish	Finish	Semi Finish	Finish	Semi Finish	Finish	Semi Finish	Finish	Semi Finish	Finish
			Fz - mm/tooth															
Steels	P	Low Carbon	0.12	0.06	0.15	0.075	0.18	0.09	0.24	0.12	0.3	0.15	0.36	0.18	0.48	0.24	0.6	0.3
		Medium Carbon	0.12	0.06	0.15	0.075	0.18	0.09	0.24	0.12	0.3	0.15	0.36	0.18	0.48	0.24	0.6	0.3
		Alloy Steels	0.12	0.06	0.15	0.075	0.18	0.09	0.24	0.12	0.3	0.15	0.36	0.18	0.48	0.24	0.6	0.3
		Die/Tool Steels	0.08	0.06	0.1	0.075	0.12	0.09	0.16	0.12	0.2	0.15	0.24	0.18	0.32	0.24	0.4	0.3
Stainless Steels	M	Free Machining	0.08	0.06	0.1	0.075	0.12	0.09	0.16	0.12	0.2	0.15	0.24	0.18	0.32	0.24	0.4	0.3
		Austenitic	0.08	0.06	0.1	0.075	0.12	0.09	0.16	0.12	0.2	0.15	0.24	0.18	0.32	0.24	0.4	0.3
		Difficult Stainless	0.08	0.06	0.1	0.075	0.12	0.09	0.16	0.12	0.2	0.15	0.24	0.18	0.32	0.24	0.4	0.3
		PH Stainless	0.08	0.06	0.1	0.075	0.12	0.09	0.16	0.12	0.2	0.15	0.24	0.18	0.32	0.24	0.4	0.3
		Cobalt Chrome Alloys	0.072	0.048	0.09	0.06	0.108	0.072	0.144	0.096	0.18	0.12	0.216	0.144	0.288	0.192	0.36	0.24
		Duplex (22%)	0.072	0.048	0.09	0.06	0.108	0.072	0.144	0.096	0.18	0.12	0.216	0.144	0.288	0.192	0.36	0.24
		Super Duplex (25%)	0.068	0.044	0.085	0.055	0.102	0.066	0.136	0.088	0.17	0.11	0.204	0.132	0.272	0.176	0.34	0.22
Special Alloys	S	High Temp Alloys	0.06	0.04	0.075	0.05	0.09	0.06	0.12	0.08	0.15	0.1	0.18	0.12	0.24	0.16	0.3	0.2
		Titanium Alloys	0.06	0.04	0.075	0.05	0.09	0.06	0.12	0.08	0.15	0.1	0.18	0.12	0.24	0.16	0.3	0.2
Cast Irons	K	Gray Cast Iron	0.12	0.08	0.15	0.1	0.18	0.12	0.24	0.16	0.3	0.2	0.36	0.24	0.48	0.32	0.6	0.4
		Ductile Cast Iron	0.1	0.08	0.125	0.1	0.15	0.12	0.2	0.16	0.25	0.2	0.3	0.24	0.4	0.32	0.5	0.4
		Malleable Iron	0.08	0.06	0.1	0.075	0.12	0.09	0.16	0.12	0.2	0.15	0.24	0.18	0.32	0.24	0.4	0.3
Hardened Steels	H	Hardened Steels HRC45-50	0.06	0.056	0.075	0.07	0.09	0.084	0.12	0.112	0.15	0.14	0.18	0.168	0.24	0.224	0.3	0.28
		Hardened Steels HRC50-55	0.05	0.056	0.063	0.07	0.075	0.084	0.1	0.112	0.125	0.14	0.15	0.168	0.2	0.224	0.25	0.28

TuffCut® XT Series MFB

Recommended cutting data | Conditions de coupe recommandées | Empfohlene Schnittdaten | Dati di taglio Raccomandati | Zalecane Parametry

Tool Ø	Effective Diameter at 30°						
	Axial Depth of Cut (mm) AP						
	0.2	0.4	0.6	0.8	1	1.5	2
4	3.31	3.68	3.87	3.97	-	-	-
5	4.00	4.45	4.71	4.87	4.96	-	-
6	4.66	5.16	5.52	5.73	5.87	-	-
8	5.96	6.62	7.05	7.36	7.60	7.91	-
10	7.22	8.00	8.51	8.90	9.20	9.68	9.93
12	8.46	9.33	9.94	10.38	10.74	11.37	11.75
16	10.88	11.92	12.66	13.24	13.71	14.58	15.16
20	13.25	14.44	15.30	15.98	16.55	17.62	18.40

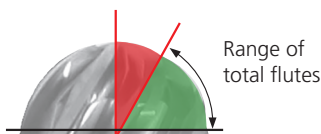
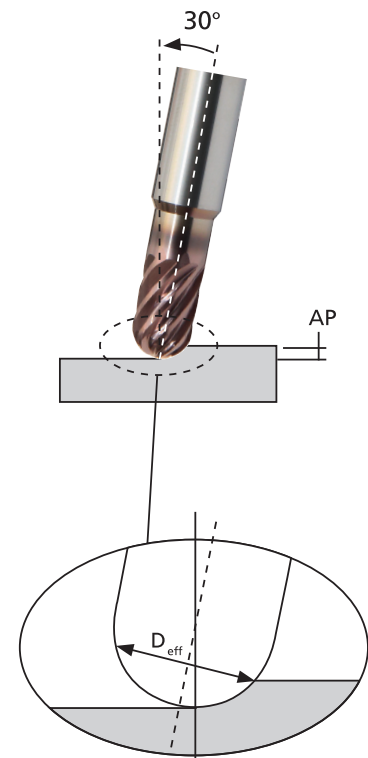

R	Tilt Angle	No. of Flutes
4	+31°	6
5	+33°	6
6	+33°	6
8	+25°	8
10	+22°	8
12	+24°	8
16	+25°	8
20	+25°	10

Tool Ø	Effective Teeth		
	Tilt Angle		
	20°	25°	33°
4	2	4	6
5	2	4	6
6	2	4	6
8	2	8	8
10	2	8	8
12	6	8	8
16	6	8	8
20	6	10	10

Red Area:

Does not have complete effective number of flutes to centre of tool.

Green Area:

Programming at the listed tilt angle will utilise the full effective number of flutes.

ALtima® Xtreme Coating Properties	
Microhardness (HV)	3800
Max. Service Temp.	1100° C / 2012° F
Friction Coefficient	0.3 - 0.5
Designation	AX
Colour	Copper

ALtima® Nano Coating Properties	
Microhardness (HV)	3875
Max. Service Temp.	1100° C / 2012° F
Friction Coefficient	0.3
Designation	AN
Colour	Grey

TuffCut® X-AL Series 135

Feed capability - Necked Tools :: Capacités d'avance - Outils détalonnés :: Vorschubleistung - Abgesetzter Schaft :: Avanzamento - Utensili con collo scaricato :: Zalecane parametry - narzędzia z odciążoną szyjką

RPM	Diameter - mm									
	3	4	5	6	8	10	12	16	20	25
	fz 0.035	fz 0.035	fz 0.084	fz 0.12	fz 0.26	fz 0.61	fz 0.77	fz 0.79	fz 0.762	fz 0.76
4000	280	280	672	960	2080	4880	6160	6304	6096	6096
5000	350	350	840	1200	2600	6100	7700	7880	7620	7620
6000	420	420	1008	1440	3120	7320	9240	9456	9144	9144
7000	490	490	1176	1680	3640	8540	10780	11032	10668	10668
8000	560	560	1344	1920	4160	9760	12320	12608	12192	12192
9000	630	630	1512	2160	4680	10980	13860	14184	13716	13716
10000	700	700	1680	2400	5200	12200	15400	15760	15240	15240
11000	770	770	1848	2640	5720	13420	16940	17336	16764	16764
12000	840	840	2016	2880	6240	14640	18480	18912	18288	18288
13000	910	910	2184	3120	6760	15860	20020	20488	19812	19812
14000	980	980	2352	3360	7280	17080	21560	22064	21336	21336
15000	1050	1050	2520	3600	7800	18300	23100	23640	22860	22860
16000	1120	1120	2688	3840	8320	19520	24640	25216	24384	24384
17000	1190	1190	2856	4080	8840	20740	26180	26792	25908	25908
18000	1260	1260	3024	4320	9360	21960	27720	28368	27432	27432

RPM	Diameter - mm									
	3	4	5	6	8	10	12	16	20	25
	fz 0.035	fz 0.035	fz 0.084	fz 0.12	fz 0.26	fz 0.61	fz 0.77	fz 0.79	fz 0.762	fz 0.76
19000	1330	1330	3192	4560	9880	23180	29260	29944	28956	28956
20000	1400	1400	3360	4800	10400	24400	30800	31520	30480	30480
21000	1470	1470	3528	5040	10920	25620	32340	33096	32004	32004
22000	1540	1540	3696	5280	11440	26840	33880	34672	33528	33528
23000	1610	1610	3864	5520	11960	28060	35420	36248	35052	35052
24000	1680	1680	4032	5760	12480	29280	36960	37824	36576	36576
25000	1750	1750	4200	6000	13000	30500	38500	39400	38100	38100
30000	2100	2100	5040	7200	15600	36600	46200	47280	45720	45720

FEED Shown in mm/min :: Avance affichée en mm/min

Feed rate allowance for length (Slotting)

Part no. example	length	Fz	Ae	Ap
135 12N3	Short	1	1 x D	1 X D
135 12N5	Medium	x 0.7	1 x D	0.25 X D
135 1202N	Long	x 0.6	0.1 x D	1 X D

Feed rate for un-necked tools

Please calculate feed rate based upon length from table above - then apply the following factors:

Diameter

3 - 8mm
10 - 25mm

Factor

Feed mm/min x 2.0
Feed mm/min x 1.35

TuffCut® X-AL Series 135, 135B, 138B

Recommended cutting data - Al / Al Si Alloy :: Conditions de coupe recommandées :: Empfohlene Schnittdaten :: Dati di taglio Raccomandati :: Zalecane Parametry

Series	Type of cut	Vc	Diameter - mm							
			Ae	Ap	M/Min	2 - 3	4	5	6	8
						fz	fz	fz	fz	fz
135		1 x D	0.5 x D	300-425	0.035	0.035	0.075-0.1	0.1-0.23	0.175-0.3	
					0.03	0.03	0.025-0.05	0.1-0.15	0.1-0.15	
		1 x D	1 x D	250-365	0.03	0.03	0.05-0.1	0.1-0.23	0.1-0.23	
					0.03	0.03	0.05-0.1	0.1-0.23	0.1-0.23	
135B		1 x D	0.5 x D	150	0.05	0.08	0.12	0.16	0.2	
					0.025	0.025	0.025-0.05	0.1-0.15	0.1-0.15	
138B		0.1 x D	1 x D	300	0.05	0.08	0.12	0.16	0.2	
					0.025	0.025	0.025-0.05	0.1-0.15	0.1-0.15	

TuffCut® X-AL Series 135, 135B, 138B

Recommended cutting data - AI / AI Si Alloy | Conditions de coupe recommandées | Empfohlene Schnittdaten | Dati di taglio Raccomandati | Zalecane Parametry

Series	Type of cut	Vc M/Min	Diameter - mm						
			10		12		25		
			Ae	Ap	fz	fz	fz	fz	fz
135		300-425	1 x D	0.5 x D	0.175-0.3	0.25-1.15	0.38-1.02	0.38-1.02	0.38-1.02
		250-365	1 x D	1 x D	0.1-0.15	0.25-0.75	0.38-0.75	0.38-0.75	0.38-0.75
		300-425	0.2 x D	1 x D	0.1-0.23	0.25-1.15	0.38-1.02	0.38-1.02	0.38-1.02
		300-425	0.5 x D	1 x D	0.1-0.23	0.25-0.89	0.38-0.89	0.38-0.89	0.38-0.89
		250-365	1 x D	1 x D	0.1-0.15	0.25-0.75	0.38-0.75	0.38-0.75	0.38-0.75
135B		150	1 x D	0.5 x D	0.25	0.50	0.50	-	-
138B		300	0.1 x D	1 x D	0.25	0.50	0.50	-	-

TuffCut® X-AL Series 137V, 137V N3-4-5, 137VF

Recommended cutting data | Conditions de coupe recommandées | Empfohlene Schnittdaten | Dati di taglio Raccomandati | Zalecane Parametry

Series	Type of cut	Vc M/Min	Diameter - mm						
			ø 3.0		ø 4.0		ø 8.0		
			Ae	Ap	fz	fz	fz	fz	fz
137V N3 / 137VR N3		400-600	1 x D	0.25 x D	0.03	0.04	0.05	0.06	0.08
		400-600	1 x D	0.5 x D	0.03	0.04	0.05	0.06	0.08
		400-600	1 x D	1 x D	0.02	0.03	0.04	0.05	0.07
		500-700	0.75 x D	0.5 x D	0.045	0.06	0.075	0.09	0.12
		500-700	0.5 x D	1 x D	0.03	0.04	0.05	0.06	0.08
		500-700	0.5 x D	1.5 x D	0.03	0.04	0.05	0.06	0.08
		800-1000	≤ 0.1 x D	≤ 0.9 x L ²	0.036	0.054	0.072	0.09	0.126

Series	Type of cut	Vc M/Min	Diameter - mm					
			ø 10.0		ø 20.0			
			Ae	Ap	fz	fz	fz	fz
137V N3 / 137VR N3		400-600	1 x D	0.25 x D	0.10	0.12	0.16	0.20
		400-600	1 x D	0.5 x D	0.10	0.12	0.16	0.20
		400-600	1 x D	1 x D	0.09	0.11	0.15	0.19
		500-700	0.75 x D	0.5 x D	0.15	0.18	0.24	0.30
		500-700	0.5 x D	1 x D	0.10	0.12	0.16	0.20
		500-700	0.5 x D	1.5 x D	0.10	0.12	0.16	0.20
		800-1000	≤ 0.1 x D	≤ 0.9 x L ²	0.162	0.2	0.27	0.342

Series	Type of cut	Vc M/Min	Diameter - mm						
			ø 3.0		ø 4.0		ø 8.0		
			Ae	Ap	fz	fz	fz	fz	fz
137V N4		400-600	1 x D	0.25 x D	0.03	0.04	0.05	0.06	0.08
		400-600	1 x D	0.5 x D	0.03	0.04	0.05	0.06	0.08
		400-600	1 x D	1 x D	0.02	0.03	0.04	0.05	0.07
		500-700	0.75 x D	0.5 x D	0.045	0.06	0.075	0.09	0.12
		500-700	0.5 x D	1 x D	0.03	0.04	0.05	0.06	0.08
		500-700	0.5 x D	0.9 x L	0.03	0.04	0.05	0.06	0.08
		800-1000	≤ 0.1 x D	≤ 0.9 x L ²	0.036	0.054	0.072	0.09	0.126

TuffCut® X-AL Series 137V, 137V N3-4-5, 137VF

Recommended cutting data · Conditions de coupe recommandées · Empfohlene Schnittdaten · Dati di taglio Raccomandati · Zalecane Parametry

Series	Type of cut	Vc	Diameter - mm							
			Ae		Ap	M/Min	∅ 10.0	∅ 12.0	∅ 16.0	∅ 20.0
						fz	fz	fz	fz	
137V N4			1 x D	0.25 x D	400-600	0.10	0.12	0.16	0.20	
			1 x D	0.5 x D	400-600	0.10	0.12	0.16	0.20	
			1 x D	1 x D	400-600	0.09	0.11	0.15	0.19	
			0.75 x D	0.5 x D	500-700	0.15	0.18	0.24	0.30	
			0.5 x D	1 x D	500-700	0.10	0.12	0.16	0.20	
			0.5 x D	0.9 x L	500-700	0.10	0.12	0.16	0.20	
		≤ 0.1 x D	≤ 0.9 x L ²	800-1000	0.162	0.20	0.27	0.342		

Series	Type of cut	Vc	Diameter - mm								
			Ae		Ap	M/Min	∅ 3.0	∅ 4.0	∅ 5.0	∅ 6.0	∅ 8.0
						fz	fz	fz	fz	fz	
137V N5 / 137VR N5			≤ 1 x D Max	≤ 0.2 x D	300-500	0.02	0.03	0.04	0.05	0.07	
			0.1 - 0.2 x D	≤ 1 x D Max	300-500	0.03	0.06	0.08	0.10	0.14	

Series	Type of cut	Vc	Diameter - mm							
			Ae		Ap	M/Min	∅ 10.0	∅ 12.0	∅ 16.0	∅ 20.0
						fz	fz	fz	fz	
137V N5 / 137VR N5			≤ 1 x D Max	≤ 0.2 x D	300-500	0.09	0.11	0.13	0.15	
			0.1 - 0.2 x D	≤ 1 x D Max	300-500	0.16	0.18	0.2	0.23	

Profile Height-X (µm) / Surface finish

Profondeur de passe-X (µm) / Finition · Profilhöhe-X (µm)/Oberflächenausführung
 Altezza del profilo X (µm) / Finitura superficiale · Wysokość profilu-X (µm) / Wykończenie powierzchni

Ae mm	Diameter - mm							
	1	2	4	6	8	10	12	16
0.06	0.9	0.45	0.23	0.15	0.11	0.09	0.08	0.06
0.08	1.6	0.8	0.4	0.27	0.2	0.16	0.13	0.1
0.11	3	1.5	0.76	0.5	0.38	0.3	0.25	0.19
0.15	5.7	2.8	1.4	0.94	0.7	0.56	0.47	0.35
0.2	10	5	2.5	1.7	1.3	1	0.83	0.63
0.3	23	11	5.6	3.8	2.8	2.3	1.9	1.41
0.45	53	26	13	8.4	6.3	5.1	4.2	3.16

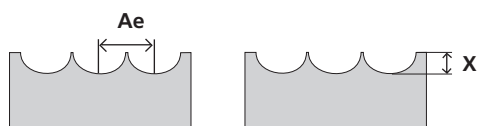

Now your end mills have done their job, why not let us re-manufacture them to our OE standard so they can do it all over again?



When you select end mills from M.A.Ford® Europe, you're not only choosing precision, performance and enhanced productivity, but also the ability to get extended use by having your pre-used end mills re-manufactured to our original OE specifications at a fraction of the cost of purchasing a new tool.



“Maintenant que vos fraises ont fait leur travail, pourquoi ne nous laissez-vous pas les re-conditionner à nos normes standard de fabrication (OE), afin qu’elles puissent de nouveau accomplir leur tâche?”

Lorsque vous choisissez des fraises M.A.Ford® Europe, vous ne choisissez pas seulement la précision, la performance ou une productivité accrue, mais également la possibilité d'étendre leur utilisation en re-conditionnant à neuf vos fraises usagées, avec leurs spécificités initiales, à un coût moindre que si vous aviez dû acheter à neuf.”



Ora che le frese hanno fatto il loro lavoro, perché non ce le fai ripristinare secondo le nostre specifiche di produzione originali, perché possano ricominciare da capo?

Quando scegli le frese di M.A.Ford® Europe, non scegli solo la precisione, le prestazioni e la maggiore produttività, ma anche la possibilità di un utilizzo prolungato grazie al servizio di ripristino degli utensili usurati secondo le nostre specifiche originali, ad una frazione del costo di un utensile nuovo.



Was geschieht mit Ihren Schafffräsern, die alle ihre Aufgaben erfüllt und das Ende ihrer betrieblichen Nutzungsdauer erreicht haben? Warum überlassen Sie uns diese Werkzeuge nicht einfach zur Wiederverwertung in der Neufertigung gemäß unseren OE-Normen, sodass sie erneut eingesetzt werden können?

Wenn Ihre Auswahl auf Schafffräser von M.A. Ford Europe fällt, dann entscheiden Sie sich nicht nur für Präzision, Leistungsstärke und verbesserte Produktivität, sondern auch für die Möglichkeit, Ihre gebrauchten Schafffräser gemäß unseren OE-Originalvorgaben neu fertigen zu lassen und dafür nur einen Bruchteil der Kosten zu tragen, die Sie für den Kauf eines neuen Werkzeugs aufwenden müssten.



Kiedy Twoje frezy wykonały swoją pracę, pozwól nam zregenerować narzędzie zgodnie z naszymi standardami, aby znów mogły wykonać swoją pracę. Wybierając frezy M.A.Ford® Europe stawiasz na precyzję i wydajność

Gwarantujemy również zwiększoną produktywność, możliwość długiego użytkowania dzięki zastosowaniu narzędzi wyprodukowanych ponownie, jedynie za część ceny nowego narzędzia.

Full regrind and re-coat service available



For further information please contact:

Tel: +44 (0)1332 267 960

TuffCut®

Carbide End Mills

..... Fraises carbure en bout Hartmetall-Schaftfräser
 Frese in Metallo Duro Integrale
 Frezy palcowe pełnowęglkowe

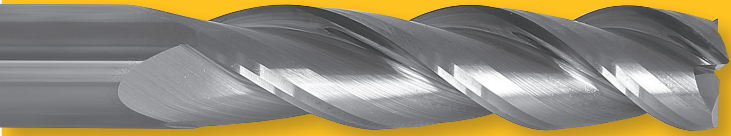

For the efficient general purpose milling of all steels, cast irons and most other materials, including aluminium and softer alloys, our FordMax range provides a complete family of standard carbide end mills designed for batch production on applications where absolute performance is not essential.

(FR)

“Pour l’efficacité des fraises à usage général dans les aciers, fontes et la plupart des autres matériaux, y compris l’aluminium et les alliages légers, notre gamme FordMax vous propose un éventail complet de fraises carbure standard conçues pour la production en petite série, pour des utilisations où la performance absolue n’est pas nécessaire.”

(DE)

Zum effizienten Ausführen von Universalfräsarbeiten bei allen Stahllarten, Gusseisen und vielen anderen Materialien, einschließlich Aluminium und weicheren Legierungen, stellt unser FordMax-Sortiment eine vollständige Produktfamilie von standardmäßigen Hartmetall-Schaftfräsern zur Verfügung. Diese ist zur Serienfertigung für Anwendungen ausgelegt sind, bei denen eine unschlagbare Leistung nicht unbedingt erforderlich ist.

(IT)

Nel programma FordMax è disponibile una famiglia di utensili in metallo duro per uso generico, idonei alla fresatura di tutti gli acciai, ghise, e della maggior parte dei materiali, compresi l’alluminio e le leghe leggere. Efficienti per lotti di produzione o applicazioni dove non sono necessarie le altissime prestazioni.

(PL)

W celu sprawnego ogólnego frezowania metali, żeliwa i większości materiałów. FordMax to kompletna gama standardowych frezów palcowych pełnowęglkowych zaprojektowanych do produkcji seryjnej w zastosowaniach, gdzie absolutna wydajność nie jest konieczna.

	Page
TuffCut® GP Endmills Series 164, 169, 163	82
TuffCut® GP Endmills Series 166, 165	83
TuffCut® GP Endmills Series 192	84
TuffCut® GP Endmills Series 121, 116, 111	84-85
TuffCut® GP Endmills Series 150, 140	86
TuffCut® GP Endmills Series VCM60, VCM90, ACR	87
TuffCut® GP Endmills Series MV4 with Corner Chamfer or Corner Radius	88-90
TuffCut® GP Endmills Series ASV4ACM	91
TuffCut® GP Endmills Series ASV4ACM-R	92
TuffCut® GP Endmills Series VMH	93
TuffCut® GP Endmills Series VMH-W, V4L	94
TuffCut® GP Endmills Series ASV4ACB, V4LB	95
TuffCut® GP Endmills Series GT2, GT3, ASVSM	96
TuffCut® GP Endmills Series GT2R, GT3R	97
TuffCut® GP Endmills Series GT2B, GT3B	98
TuffCut® GP Endmills Series 134	98
Technical Information	99-106

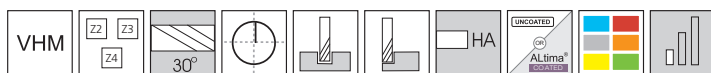

TuffCut® GP Series 164, 169, 163

Z2

Z3

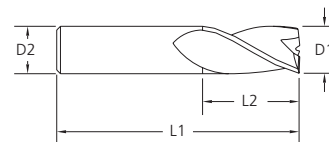
Z4

Series 164		Series 169		Series 163		Tool Dimensions			
Uncoated	Coated	Uncoated	Coated	Uncoated	Coated	Ø D1	Ø D2	L1	L2
Tool No	Tool No	Tool No	Tool No	Tool No	Tool No				
164 0020	-	-	-	-	-	0.2	3.0	38.0	0.4
164 0030	-	-	-	-	-	0.3	3.0	38.0	0.6
164 0040	-	-	-	-	-	0.4	3.0	38.0	0.8
164 0050	-	-	-	-	-	0.5	3.0	38.0	1.0
164 0060	-	-	-	-	-	0.6	3.0	38.0	1.2
164 0070	-	-	-	-	-	0.7	3.0	38.0	1.4
164 0080	-	-	-	-	-	0.8	3.0	38.0	1.6
164 0090	-	-	-	-	-	0.9	3.0	38.0	1.8
164 0100	-	169 0100	-	163 0100	-	1.0	3.0	38.0	2.0
164 0110	-	-	-	-	-	1.1	3.0	38.0	2.2
164 0120	-	-	-	-	-	1.2	3.0	38.0	2.4
164 0130	-	-	-	-	-	1.3	3.0	38.0	2.6
164 0140	-	-	-	-	-	1.4	3.0	38.0	2.8
164 0150	-	169 0150	-	163 0150	163 0150A	1.5	3.0	38.0	3.0
164 0160	-	-	-	-	-	1.6	3.0	38.0	3.2
164 0170	-	-	-	-	-	1.7	3.0	38.0	3.4
164 0180	-	-	-	-	-	1.8	3.0	38.0	3.6
164 0190	-	-	-	-	-	1.9	3.0	38.0	3.8
164 0200	-	169 0200	-	163 0200	-	2.0	3.0	38.0	4.0
164 0250	-	169 0250	-	163 0250	163 0250A	2.5	3.0	38.0	5.0
164 0300	164 0300A	169 0300	169 0300A	163 0300	163 0300A	3.0	3.0	38.0	6.0
164 0350	-	169 0350	-	163 0350	-	3.5	4.0	51.0	7.0
164 0400	164 0400A	169 0400	169 0400A	163 0400	163 0400A	4.0	4.0	51.0	8.0
164 0450	-	169 0450	-	163 0450	-	4.5	5.0	51.0	9.0
164 0500	164 0500A	169 0500	169 0500A	163 0500	163 0500A	5.0	5.0	51.0	11.0
164 0550	-	169 0550	-	163 0550	-	5.5	6.0	51.0	12.0
164 0600	164 0600A	169 0600	169 0600A	163 0600	163 0600A	6.0	6.0	51.0	13.0
164 0700	-	169 0700	-	163 0700	-	7.0	8.0	51.0	13.0
164 0800	164 0800A	169 0800	169 0800A	163 0800	163 0800A	8.0	8.0	51.0	13.0
164 0900	-	169 0900	-	163 0900	-	9.0	9.0	51.0	14.0
164 1000	164 1000A	169 1000	169 1000A	163 1000	163 1000A	10.0	10.0	51.0	14.0
164 1100	-	169 1100	-	163 1100	-	11.0	11.0	64.0	16.0
164 1200	164 1200A	169 1200	169 1200A	163 1200	163 1200A	12.0	12.0	64.0	16.0
164 1400	-	169 1400	-	163 1400	-	14.0	14.0	70.0	18.0
164 1600	164 1600A	169 1600	169 1600A	163 1600	163 1600A	16.0	16.0	76.0	20.0
164 1800	-	169 1800	169 1800A	163 1800	-	18.0	18.0	76.0	25.0
164 2000	164 2000A	169 2000	169 2000A	163 2000	163 2000A	20.0	20.0	76.0	25.0



TuffCut® GP Series 166, 165

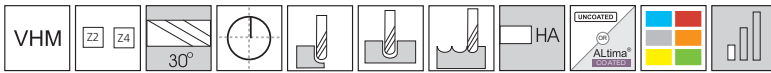

Z2



Z4

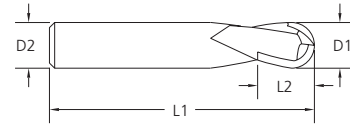

Series 166		Series 165		Tool Dimensions			
Uncoated	Coated	Uncoated	Coated	Ø D1	Ø D2	L1	L2
Tool No	Tool No	Tool No	Tool No				
166 0100	-	165 0100	165 0100A	1.0	3.0	38.0	2.0
166 0150	-	165 0150	-	1.5	3.0	38.0	3.0
166 0200	-	165 0200	165 0200A	2.0	3.0	38.0	4.0
166 0250	-	165 0250	165 0250A	2.5	3.0	38.0	5.0
166 0300	166 0300A	165 0300	165 0300A	3.0	3.0	38.0	6.0
166 0350	-	165 0350	-	3.5	4.0	51.0	7.0
166 0400	166 0400A	165 0400	165 0400A	4.0	4.0	51.0	8.0
166 0450	-	165 0450	-	4.5	5.0	51.0	9.0
166 0500	166 0500A	165 0500	165 0500A	5.0	5.0	51.0	11.0
166 0550	-	165 0550	-	5.5	6.0	51.0	12.0
166 0600	166 0600A	165 0600	165 0600A	6.0	6.0	51.0	13.0
166 0700	-	165 0700	-	7.0	8.0	51.0	13.0
166 0800	166 0800A	165 0800	165 0800A	8.0	8.0	51.0	13.0
166 0900	-	165 0900	-	9.0	9.0	51.0	14.0
166 1000	166 1000A	165 1000	165 1000A	10.0	10.0	51.0	14.0
166 1100	-	165 1100	-	11.0	11.0	64.0	16.0
166 1200	166 1200A	165 1200	165 1200A	12.0	12.0	64.0	16.0
166 1400	-	165 1400	-	14.0	14.0	70.0	18.0
166 1600	166 1600A	165 1600	165 1600A	16.0	16.0	76.0	20.0
166 1800	-	165 1800	-	18.0	18.0	76.0	25.0
166 2000	166 2000A	165 2000	165 2000A	20.0	20.0	76.0	25.0



TuffCut® GP Series 192

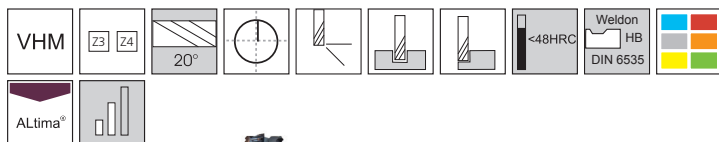

Z3 Z4

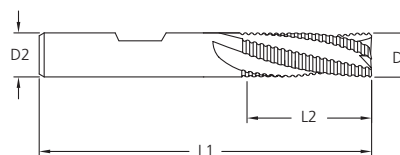

Series 192		Tool Dimensions				
Tool No.		Ø D1	Ø D2	L1	L2	Z
192 0800A		8.0	8.0	51.0	8.0	3
192 0801A		8.0	8.0	64.0	16.0	3
192 1000A		10.0	10.0	51.0	10.0	4
192 1001A		10.0	10.0	70.0	20.0	4
192 1200A		12.0	12.0	64.0	12.0	4
192 1201A		12.0	12.0	76.0	25.0	4
192 1600A		16.0	16.0	76.0	16.0	4
192 1601A		16.0	16.0	89.0	32.0	4
192 2000A		20.0	20.0	76.0	20.0	4
192 2001A		20.0	20.0	102.0	38.0	4



TuffCut® GP Series 121, 116, 111

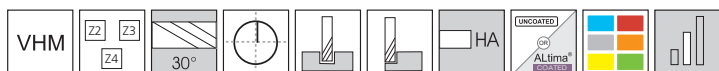

Z2



Z3



Z4

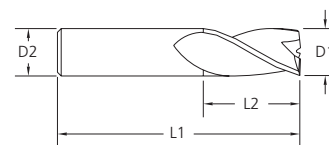

Series 121		Series 116		Series 111		Tool Dimensions			
Uncoated	Coated	Uncoated	Coated	Uncoated	Coated	Ø D1	Ø D2	L1	L2
Tool No.	Tool No.	Tool No.	Tool No.	Tool No.	Tool No.				
121 0020	-	-	-	111 0020	-	0.2	3.0	38.0	0.6
121 0030	-	-	-	111 0030	-	0.3	3.0	38.0	0.9
121 0040	-	-	-	111 0040	-	0.4	3.0	38.0	1.2
121 0050	121 0050A	-	-	111 0050	-	0.5	3.0	38.0	1.5
121 0060	-	-	-	111 0060	-	0.6	3.0	38.0	1.8
121 0070	-	-	-	111 0070	-	0.7	3.0	38.0	2.1
121 0080	-	-	-	111 0080	-	0.8	3.0	38.0	2.4
121 0090	121 0090A	-	-	111 0090	-	0.9	3.0	38.0	2.7
121 0100	121 0100A	116 0100	116 0100A	111 0100	111 0100A	1.0	3.0	38.0	3.0



TuffCut® GP Series 121, 116, 111

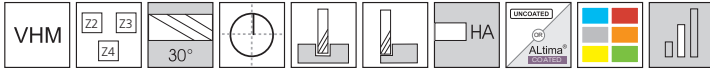

Z2



Z3



Z4

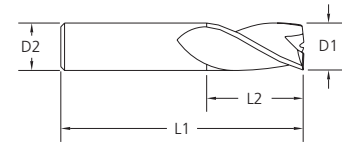

Series 121		Series 116		Series 111		Tool Dimensions			
Uncoated	Coated	Uncoated	Coated	Uncoated	Coated	Ø D1	Ø D2	L1	L2
Tool No.	Tool No.	Tool No.	Tool No.	Tool No.	Tool No.				
121 0110	121 0110A	-	-	111 0110	-	1.1	3.0	38.0	3.3
121 0120	121 0120A	-	-	111 0120	111 0120A	1.2	3.0	38.0	3.6
121 0130	121 0130A	-	-	111 0130	-	1.3	3.0	38.0	3.9
121 0140	121 0140A	-	-	111 0140	-	1.4	3.0	38.0	4.2
121 0150-1	-	-	-	111 0150-1	-	1.5	3.0	38.0	4.5
121 0150	121 0150A	116 0150	116 0150A	111 0150	111 0150A	1.5	3.0	38.0	6.0
121 0160	121 0160A	-	-	111 0160	-	1.6	3.0	38.0	4.8
121 0170	-	-	-	111 0170	-	1.7	3.0	38.0	5.1
121 0180	-	-	-	111 0180	-	1.8	3.0	38.0	5.4
121 0190	-	-	-	111 0190	-	1.9	3.0	38.0	5.7
121 0200-1	121 0200-1A	-	-	111 0200-1	-	2.0	3.0	38.0	6.0
121 0200	121 0200A	116 0200	116 0200A	111 0200	111 0200A	2.0	3.0	38.0	9.0
121 0250	121 0250A	116 0250	116 0250A	111 0250	111 0250A	2.5	3.0	38.0	12.0
121 0300	121 0300A	116 0300	116 0300A	111 0300	111 0300A	3.0	3.0	38.0	12.0
121 0350	121 0350A	116 0350	116 0350A	111 0350	111 0350A	3.5	4.0	51.0	12.0
121 0400	121 0400A	116 0400	116 0400A	111 0400	111 0400A	4.0	4.0	51.0	14.0
121 0450	121 0450A	116 0450	-	111 0450	111 0450A	4.5	5.0	51.0	14.0
121 0500	121 0500A	116 0500	116 0500A	111 0500	111 0500A	5.0	5.0	51.0	20.0
121 0550	-	116 0550	-	111 0550	111 0550A	5.5	6.0	64.0	20.0
121 0600	121 0600A	116 0600	116 0600A	111 0600	111 0600A	6.0	6.0	64.0	20.0
121 0700	121 0700A	116 0700	-	111 0700	111 0700A	7.0	8.0	64.0	20.0
121 0800	121 0800A	116 0800	116 0800A	111 0800	111 0800A	8.0	8.0	64.0	20.0
121 0900	121 0900A	116 0900	-	111 0900	111 0900A	9.0	9.0	64.0	20.0
121 1000	121 1000A	116 1000	116 1000A	111 1000	111 1000A	10.0	10.0	70.0	25.0
121 1100	121 1100A	116 1100	-	111 1100	-	11.0	11.0	70.0	25.0
121 1200	121 1200A	116 1200	116 1200A	111 1200	111 1200A	12.0	12.0	76.0	25.0
121 1400	121 1400A	116 1400	-	111 1400	111 1400A	14.0	14.0	89.0	30.0
121 1600	121 1600A	116 1600	116 1600A	111 1600	111 1600A	16.0	16.0	89.0	30.0
121 1800	121 1800A	116 1800	-	111 1800	111 1800A	18.0	18.0	102.0	35.0
121 2000	121 2000A	116 2000	116 2000A	111 2000	111 2000A	20.0	20.0	102.0	38.0
121 2200	-	116 2200	-	111 2200	-	22.0	22.0	102.0	40.0
121 2500	121 2500A	116 2500	116 2500A	111 2500	111 2500A	25.0	25.0	102.0	40.0



TuffCut® GP Series 150,140

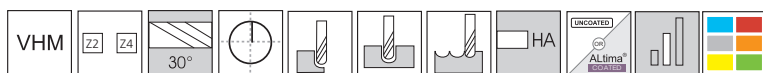

Z2



Z4

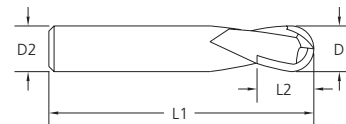

Series 150		Series 140		Tool Dimensions			
Uncoated	Coated	Uncoated	Coated	Ø D1	Ø D2	L1	L2
Tool No.	Tool No.	Tool No.	Tool No.				
150 0040	-	-	-	0.4	3.0	38.0	1.2
150 0050	-	-	-	0.5	3.0	38.0	1.5
150 0060	-	-	-	0.6	3.0	38.0	1.8
150 0070	-	-	-	0.7	3.0	38.0	2.1
150 0080	-	-	-	0.8	3.0	38.0	2.4
150 0090	-	-	-	0.9	3.0	38.0	2.7
150 0100	150 0100A	140 0100	140 0100A	1.0	3.0	38.0	3.0
150 0110	-	-	-	1.1	3.0	38.0	3.3
150 0120	-	-	-	1.2	3.0	38.0	3.6
150 0130	-	-	-	1.3	3.0	38.0	3.9
150 0140	-	-	-	1.4	3.0	38.0	4.2
150 0150-1	-	-	-	1.5	3.0	38.0	4.5
150 0150	150 0150A	140 0150	140 0150A	1.5	3.0	38.0	6.0
150 0160	-	-	-	1.6	3.0	38.0	4.8
150 0170	-	-	-	1.7	3.0	38.0	5.1
150 0180	-	-	-	1.8	3.0	38.0	5.4
150 0190	-	-	-	1.9	3.0	38.0	5.7
150 0200-1	-	-	-	2.0	3.0	38.0	6.0
150 0200	150 0200A	140 0200	140 0200A	2.0	3.0	38.0	9.0
150 0250	150 0250A	140 0250	140 0250A	2.5	3.0	38.0	12.0
150 0300	150 0300A	140 0300	140 0300A	3.0	3.0	38.0	12.0
150 0350	150 0350A	140 0350	140 0350A	3.5	4.0	51.0	12.0
150 0400	150 0400A	140 0400	140 0400A	4.0	4.0	51.0	14.0
150 0450	150 0450A	140 0450	-	4.5	5.0	51.0	14.0
150 0500	150 0500A	140 0500	140 0500A	5.0	5.0	51.0	20.0
150 0550	-	140 0550	-	5.5	6.0	64.0	20.0
150 0600	150 0600A	140 0600	140 0600A	6.0	6.0	64.0	20.0
150 0700	150 0700A	140 0700	-	7.0	8.0	64.0	20.0
150 0800	150 0800A	140 0800	140 0800A	8.0	8.0	64.0	20.0
150 0900	-	140 0900	-	9.0	9.0	64.0	20.0
150 1000	150 1000A	140 1000	140 1000A	10.0	10.0	70.0	25.0
150 1100	-	140 1100	-	11.0	11.0	70.0	25.0
150 1200	150 1200A	140 1200	140 1200A	12.0	12.0	76.0	25.0
150 1400	-	140 1400	-	14.0	14.0	89.0	30.0
150 1600	150 1600A	140 1600	140 1600A	16.0	16.0	89.0	30.0
150 1800	-	140 1800	-	18.0	18.0	102.0	35.0
150 2000	150 2000A	140 2000	140 2000A	20.0	20.0	102.0	38.0
150 2200	-	140 2200	-	22.0	22.0	102.0	40.0
150 2500	150 2500A	140 2500	140 2500A	25.0	25.0	102.0	40.0

TuffCut® GP Chamfer Mills Series VCM60, VCM90

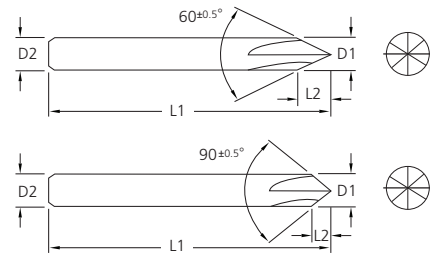
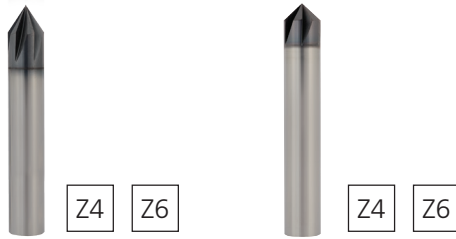
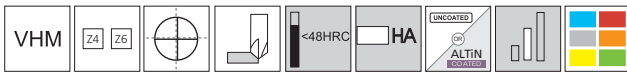

Series VCM60		Series VCM90		Tool Dimensions					
Uncoated	Coated	Uncoated	Coated	Ø D1	Ø D2	Angle	L1	L2	Z
VCM60 0400	VCM60 0400A	-	-	4.0	4.0	60°	51.0	3.3	4
-	-	VCM90 0400	VCM90 0400A	4.0	4.0	90°	51.0	1.8	4
VCM60 0600	VCM60 0600A	-	-	6.0	6.0	60°	64.0	5.0	4
-	-	VCM90 0600	VCM90 0600A	6.0	6.0	90°	64.0	2.8	4
VCM60 0800	VCM60 0800A	-	-	8.0	8.0	60°	64.0	6.8	4
-	-	VCM90 0800	VCM90 0800A	8.0	8.0	90°	64.0	3.8	4
VCM60 1000	VCM60 1000A	-	-	10.0	10.0	60°	73.0	8.5	6
-	-	VCM90 1000	VCM90 1000A	10.0	10.0	90°	73.0	4.8	6
VCM60 1200	VCM60 1200A	-	-	12.0	12.0	60°	84.0	10.0	6
-	-	VCM90 1200	VCM90 1200A	12.0	12.0	90°	84.0	5.8	6
VCM60 1600	VCM60 1600A	-	-	16.0	16.0	60°	93.0	13.5	6
-	-	VCM90 1600	VCM90 1600A	16.0	16.0	90°	93.0	7.8	6

TuffCut® GP Corner Rounding Series ACR

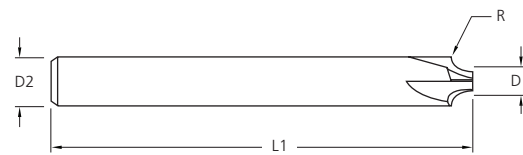
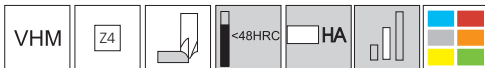

Series ACR	Tool Dimensions			
Tool No.	Ø D1	D2	L1	R
ACR0300-0.25R	2.3 / 2.4	3.0	51.0	0.25
ACR0400-0.5R	2.8 / 2.9	4.0	51.0	0.5
ACR0500-0.75R	3.3 / 3.4	5.0	57.0	0.75
ACR0500-1.0R	2.7 / 2.9	5.0	57.0	1.0
ACR0600-1.5R	2.7 / 2.9	6.0	64.0	1.5
ACR0600-2.0R	1.7 / 1.9	6.0	64.0	2.0
ACR0800-2.0R	3.7 / 3.9	8.0	64.0	2.0
ACR1000-3.0R	3.7 / 3.9	10.0	73.0	3.0
ACR1200-4.0R	3.7 / 3.9	12.0	84.0	4.0
ACR1600-5.0R	5.7 / 5.9	16.0	93.0	5.0
ACR1600-6.0R	3.7 / 3.9	16.0	93.0	6.0

TuffCut® GP Series MV4 with Corner Chamfer or Corner Radius

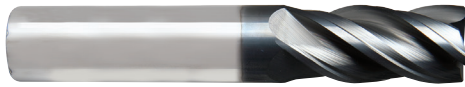
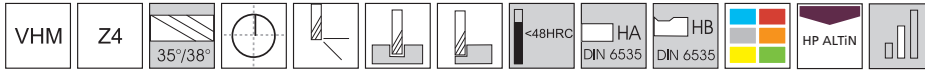
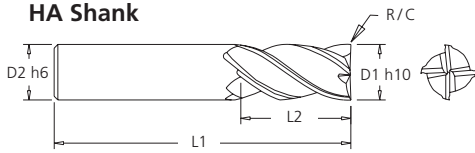
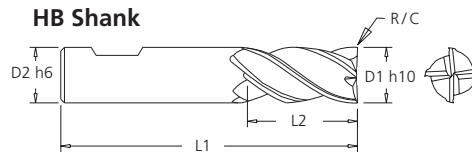
HA Shank

HB Shank

Series MV4	Tool Dimensions						
	Tool No.	Ø D1	Ø D2	L1	L2	R	C x 45°
MV4 0303HX	3.0	3.0	50.0	6.0	-	0.1	HA
MV4 0303-0.25RHX	3.0	3.0	50.0	6.0	0.25	-	HA
MV4 0303-12HX	3.0	3.0	50.0	12.0	-	0.1	HA
MV4 0303-12-0.25RHX	3.0	3.0	50.0	12.0	0.25	-	HA
MV4 03HX	3.0	6.0	64.0	6.0	-	0.1	HA
MV4 03-0.25RHX	3.0	6.0	64.0	6.0	0.25	-	HA
MV4 04HX	4.0	6.0	64.0	11.0	-	0.1	HA
MV4 04-0.25RHX	4.0	6.0	64.0	11.0	0.25	-	HA
MV4 04-0.5RHX	4.0	6.0	64.0	11.0	0.5	-	HA
MV4 04-1.0RHX	4.0	6.0	64.0	11.0	1.0	-	HA
MV4 05HX	5.0	6.0	64.0	12.0	-	0.1	HA
MV4 05-0.25RHX	5.0	6.0	64.0	12.0	0.25	-	HA
MV4 05-0.5RHX	5.0	6.0	64.0	12.0	0.5	-	HA
MV4 05-1.0RHX	5.0	6.0	64.0	12.0	1.0	-	HA
MV4 05-15HX	5.0	6.0	64.0	15.0	-	0.1	HA
MV4 05-15-0.5RHX	5.0	6.0	64.0	15.0	0.5	-	HA
MV4 06HX	6.0	6.0	64.0	15.0	-	0.1	HA
MV4 06HXW	6.0	6.0	64.0	15.0	-	0.1	HB
MV4 06-0.25RHX	6.0	6.0	64.0	15.0	0.25	-	HA
MV4 06-0.25RHXW	6.0	6.0	64.0	15.0	0.25	-	HB
MV4 06-0.5RHX	6.0	6.0	64.0	15.0	0.5	-	HA
MV4 06-0.5RHXW	6.0	6.0	64.0	15.0	0.5	-	HB
MV4 06-1.0RHX	6.0	6.0	64.0	15.0	1.0	-	HA
MV4 06-1.0RHXW	6.0	6.0	64.0	15.0	1.0	-	HB
MV4 06-19HX	6.0	6.0	64.0	19.0	-	0.1	HA
MV4 06-19-0.25RHX	6.0	6.0	64.0	19.0	0.25	-	HA
MV4 06-19-0.5RHX	6.0	6.0	64.0	19.0	0.5	-	HA
MV4 06-19-1.0RHX	6.0	6.0	64.0	19.0	1.0	-	HA
MV4 08HX	8.0	8.0	64.0	22.0	-	0.15	HA
MV4 08HXW	8.0	8.0	64.0	22.0	-	0.15	HB
MV4 08-0.25RHX	8.0	8.0	64.0	22.0	0.25	-	HA
MV4 08-0.25RHXW	8.0	8.0	64.0	22.0	0.25	-	HB
MV4 08-0.5RHX	8.0	8.0	64.0	22.0	0.5	-	HA
MV4 08-0.5RHXW	8.0	8.0	64.0	22.0	0.5	-	HB
MV4 08-1.0RHX	8.0	8.0	64.0	22.0	1.0	-	HA
MV4 08-1.0RHXW	8.0	8.0	64.0	22.0	1.0	-	HB
MV4 08-1.5RHX	8.0	8.0	64.0	22.0	1.5	-	HA
MV4 08-1.5RHXW	8.0	8.0	64.0	22.0	1.5	-	HB
MV4 08-2.0RHX	8.0	8.0	64.0	22.0	2.0	-	HA
MV4 08-2.0RHXW	8.0	8.0	64.0	22.0	2.0	-	HB
MV4 10HX	10.0	10.0	73.0	22.0	-	0.15	HA
MV4 10HXW	10.0	10.0	73.0	22.0	-	0.15	HB

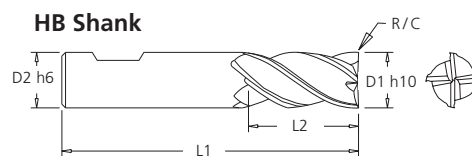
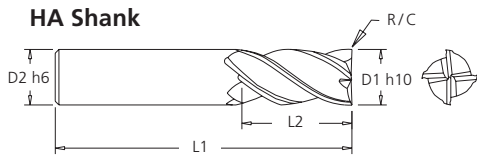
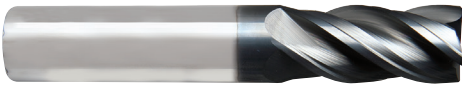
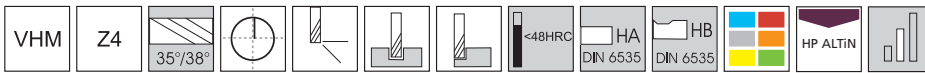
TuffCut® GP Series MV4 with Corner Chamfer or Corner Radius



Series MV4	Tool Dimensions						
Tool No.	Ø D1	Ø D2	L1	L2	R	C x 45°	Shank
MV4 10-0.5RHX	10.0	10.0	73.0	22.0	0.5	-	HA
MV4 10-0.5RHXW	10.0	10.0	73.0	22.0	0.5	-	HB
MV4 10-1.0RHX	10.0	10.0	73.0	22.0	1.0	-	HA
MV4 10-1.0RHXW	10.0	10.0	73.0	22.0	1.0	-	HB
MV4 10-1.5RHX	10.0	10.0	73.0	22.0	1.5	-	HA
MV4 10-1.5RHXW	10.0	10.0	73.0	22.0	1.5	-	HB
MV4 10-2.0RHX	10.0	10.0	73.0	22.0	2.0	-	HA
MV4 10-2.0RHXW	10.0	10.0	73.0	22.0	2.0	-	HB
MV4 10-2.5RHX	10.0	10.0	73.0	22.0	2.5	-	HA
MV4 10-2.5RHXW	10.0	10.0	73.0	22.0	2.5	-	HB
MV4 10-3.0RHX	10.0	10.0	73.0	22.0	3.0	-	HA
MV4 10-3.0RHXW	10.0	10.0	73.0	22.0	3.0	-	HB
MV4 12HX	12.0	12.0	73.0	27.0	-	0.15	HA
MV4 12HXW	12.0	12.0	83.0	27.0	-	0.15	HB
MV4 12-0.5RHX	12.0	12.0	73.0	27.0	0.5	-	HA
MV4 12-0.5RHXW	12.0	12.0	83.0	27.0	0.5	-	HB
MV4 12-1.0RHX	12.0	12.0	73.0	27.0	1.0	-	HA
MV4 12-1.0RHXW	12.0	12.0	83.0	27.0	1.0	-	HB
MV4 12-1.5RHX	12.0	12.0	73.0	27.0	1.5	-	HA
MV4 12-1.5RHXW	12.0	12.0	83.0	27.0	1.5	-	HB
MV4 12-2.0RHX	12.0	12.0	73.0	27.0	2.0	-	HA
MV4 12-2.0RHXW	12.0	12.0	83.0	27.0	2.0	-	HB
MV4 12-2.5RHX	12.0	12.0	73.0	27.0	2.5	-	HA
MV4 12-2.5RHXW	12.0	12.0	83.0	27.0	2.5	-	HB
MV4 12-3.0RHX	12.0	12.0	73.0	27.0	3.0	-	HA
MV4 12-3.0RHXW	12.0	12.0	83.0	27.0	3.0	-	HB
MV4 12-32HX	12.0	12.0	73.0	32.0	-	0.15	HA
MV4 12-32-1.0RHX	12.0	12.0	73.0	32.0	1.0	-	HA
MV4 16HX	16.0	16.0	92.0	33.0	-	0.3	HA
MV4 16HXW	16.0	16.0	92.0	33.0	-	0.3	HB
MV4 16-0.5RHX	16.0	16.0	92.0	33.0	0.5	-	HA
MV4 16-0.5RHXW	16.0	16.0	92.0	33.0	0.5	-	HB
MV4 16-1.0RHX	16.0	16.0	92.0	33.0	1.0	-	HA
MV4 16-1.0RHXW	16.0	16.0	92.0	33.0	1.0	-	HB
MV4 16-1.5RHX	16.0	16.0	92.0	33.0	1.5	-	HA
MV4 16-1.5RHXW	16.0	16.0	92.0	33.0	1.5	-	HB
MV4 16-2.0RHX	16.0	16.0	92.0	33.0	2.0	-	HA
MV4 16-2.0RHXW	16.0	16.0	92.0	33.0	2.0	-	HB
MV4 16-2.5RHX	16.0	16.0	92.0	33.0	2.5	-	HA
MV4 16-2.5RHXW	16.0	16.0	92.0	33.0	2.5	-	HB
MV4 16-3.0RHX	16.0	16.0	92.0	33.0	3.0	-	HA
MV4 16-3.0RHXW	16.0	16.0	92.0	33.0	3.0	-	HB

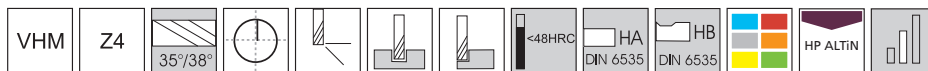
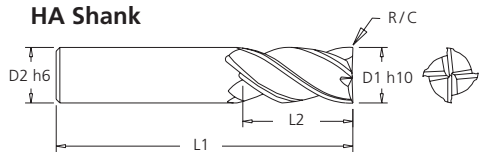
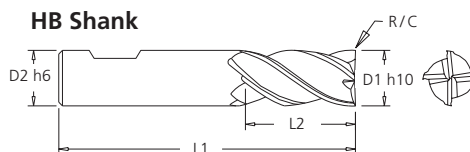

TuffCut® GP Series MV4 with Corner Chamfer or Corner Radius

HA Shank

HB Shank

Series MV4	Tool Dimensions						
Tool No.	Ø D1	Ø D2	L1	L2	R	C x 45°	Shank
MV4 20HX	20.0	20.0	104.0	40.0	-	0.3	HA
MV4 20HXW	20.0	20.0	104.0	40.0	-	0.3	HB
MV4 20-1.0RHX	20.0	20.0	104.0	40.0	1.0	-	HA
MV4 20-1.0RHXW	20.0	20.0	104.0	40.0	1.0	-	HB
MV4 20-1.5RHX	20.0	20.0	104.0	40.0	1.5	-	HA
MV4 20-1.5RHXW	20.0	20.0	104.0	40.0	1.5	-	HB
MV4 20-2.0RHX	20.0	20.0	104.0	40.0	2.0	-	HA
MV4 20-2.0RHXW	20.0	20.0	104.0	40.0	2.0	-	HB
MV4 20-3.0RHX	20.0	20.0	104.0	40.0	3.0	-	HA
MV4 20-3.0RHXW	20.0	20.0	104.0	40.0	3.0	-	HB
MV4 20-4.0RHX	20.0	20.0	104.0	40.0	4.0	-	HA
MV4 20-4.0RHXW	20.0	20.0	104.0	40.0	4.0	-	HB
MV4 20-5.0RHX	20.0	20.0	104.0	40.0	5.0	-	HA
MV4 20-5.0RHXW	20.0	20.0	104.0	40.0	5.0	-	HB
MV4 20-6.0RHX	20.0	20.0	104.0	40.0	6.0	-	HA
MV4 20-6.0RHXW	20.0	20.0	104.0	40.0	6.0	-	HB

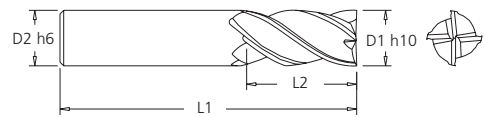
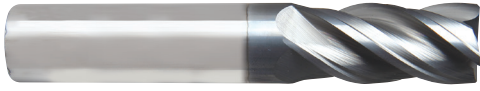
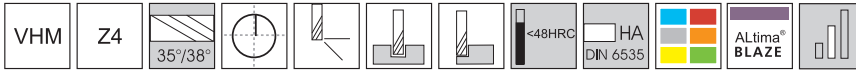

TuffCut® GP Series ASV4ACM



Z4

Series ASV4ACM	Tool Dimensions				
Tool No.	Ø D1	Ø D2	L1	L2	C x 45°
ASV4ACM0300	3.0	3.0	51.0	6.0	0.1
ASV4ACM0400	4.0	4.0	51.0	11.0	0.1
ASV4ACM0500	5.0	5.0	57.0	12.0	0.1
ASV4ACM0600	6.0	6.0	64.0	15.0	0.1
ASV4ACM0800	8.0	8.0	64.0	22.0	0.15
ASV4ACM1000	10.0	10.0	72.0	22.0	0.15
ASV4ACM1200	12.0	12.0	73.0	27.0	0.15
ASV4ACM1400	14.0	14.0	84.0	30.0	0.3
ASV4ACM1600	16.0	16.0	92.0	33.0	0.3
ASV4ACM2000	20.0	20.0	105.0	40.0	0.3



TuffCut® GP Series ASV4ACM-R

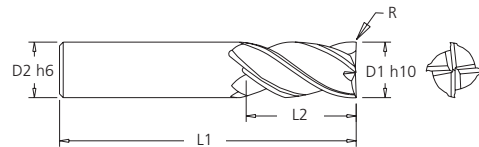
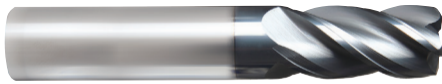
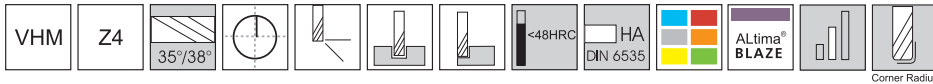

Z4

Series ASV4ACM-R	Tool Dimensions				
Tool No.	Ø D1	Ø D2	L1	L2	R
ASV4ACM0400R0.25	4.0	4.0	51.0	11.0	0.25
ASV4ACM0400R0.5	4.0	4.0	51.0	11.0	0.5
ASV4ACM0400R0.75	4.0	4.0	51.0	11.0	0.75
ASV4ACM0400R1.0	4.0	4.0	51.0	11.0	1.0
ASV4ACM0500R0.25	5.0	5.0	57.0	12.0	0.25
ASV4ACM0500R0.5	5.0	5.0	57.0	12.0	0.5
ASV4ACM0500R1.0	5.0	5.0	57.0	12.0	1.0
ASV4ACM0600R0.25	6.0	6.0	64.0	15.0	0.25
ASV4ACM0600R0.5	6.0	6.0	64.0	15.0	0.5
ASV4ACM0600R1.0	6.0	6.0	64.0	15.0	1.0
ASV4ACM0800R0.25	8.0	8.0	64.0	22.0	0.25
ASV4ACM0800R0.5	8.0	8.0	64.0	22.0	0.5
ASV4ACM0800R1.0	8.0	8.0	64.0	22.0	1.0
ASV4ACM0800R1.5	8.0	8.0	64.0	22.0	1.5
ASV4ACM0800R2.0	8.0	8.0	64.0	22.0	2.0
ASV4ACM1000R0.25	10.0	10.0	72.0	22.0	0.25
ASV4ACM1000R0.5	10.0	10.0	72.0	22.0	0.5
ASV4ACM1000R1.0	10.0	10.0	72.0	22.0	1.0
ASV4ACM1000R1.5	10.0	10.0	72.0	22.0	1.5
ASV4ACM1000R2.0	10.0	10.0	72.0	22.0	2.0
ASV4ACM1000R2.5	10.0	10.0	72.0	22.0	2.5
ASV4ACM1000R3.0	10.0	10.0	72.0	22.0	3.0
ASV4ACM1200R0.25	12.0	12.0	73.0	27.0	0.25
ASV4ACM1200R0.5	12.0	12.0	73.0	27.0	0.5
ASV4ACM1200R1.0	12.0	12.0	73.0	27.0	1.0
ASV4ACM1200R1.5	12.0	12.0	73.0	27.0	1.5
ASV4ACM1200R1.75	12.0	12.0	73.0	27.0	1.75
ASV4ACM1200R2.0	12.0	12.0	73.0	27.0	2.0
ASV4ACM1200R2.5	12.0	12.0	73.0	27.0	2.5
ASV4ACM1200R3.0	12.0	12.0	73.0	27.0	3.0
ASV4ACM1200R4.0	12.0	12.0	73.0	27.0	4.0
ASV4ACM1400R0.2	14.0	14.0	84.0	30.0	0.2
ASV4ACM1600R0.5	16.0	16.0	92.0	33.0	0.5
ASV4ACM1600R1.0	16.0	16.0	92.0	33.0	1.0
ASV4ACM1600R1.5	16.0	16.0	92.0	33.0	1.5
ASV4ACM1600R2.0	16.0	16.0	92.0	33.0	2.0
ASV4ACM1600R2.5	16.0	16.0	92.0	33.0	2.5
ASV4ACM1600R3.0	16.0	16.0	92.0	33.0	3.0
ASV4ACM1600R4.0	16.0	16.0	92.0	33.0	4.0



TuffCut® GP Series VMH

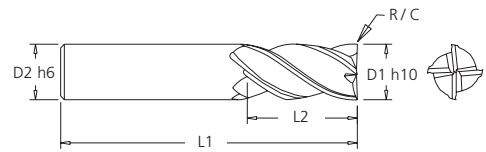
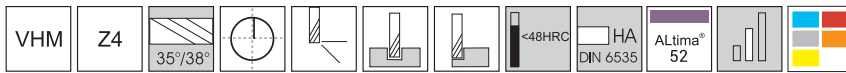

Series VMH	Tool Dimensions					
Tool No.	Ø D1	Ø D2	L1	L2	R	C x 45°
VMH 0300	3.0	6.0	64.0	7.5	-	0.15
VMH 03-0.3R	3.0	6.0	64.0	7.5	0.3	-
VMH 0400	4.0	6.0	64.0	10.0	-	0.2
VMH 04-0.3R	4.0	6.0	64.0	10.0	0.3	-
VMH 0500	5.0	6.0	64.0	12.5	-	0.2
VMH 05-0.3R	5.0	6.0	64.0	12.5	0.3	-
VMH 0600	6.0	6.0	64.0	15.0	-	0.2
VMH 06-0.3R	6.0	6.0	64.0	15.0	0.3	-
VMH 0800	8.0	8.0	64.0	20.0	-	0.25
VMH 08-0.5R	8.0	8.0	64.0	20.0	0.5	-
VMH 1000	10.0	10.0	73.0	25.0	-	0.3
VMH 10-0.5R	10.0	10.0	73.0	25.0	0.5	-
VMH 1200	12.0	12.0	84.0	30.0	-	0.35
VMH 12-1.0R	12.0	12.0	84.0	30.0	1.0	-
VMH 1600	16.0	16.0	93.0	40.0	-	0.4
VMH 16-1.0R	16.0	16.0	93.0	40.0	1.0	-
VMH 2000	20.0	20.0	105.0	50.0	-	0.5
VMH 20-1.0R	20.0	20.0	105.0	50.0	1.0	-



TuffCut® GP Series VMH-W

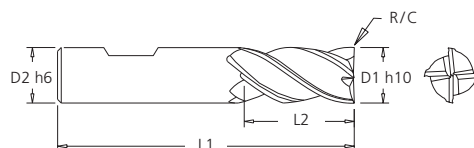
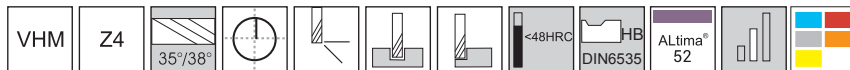

Series VMH	Tool Dimensions					
Tool No.	Ø D1	Ø D2	L1	L2	R	C x 45°
VMH 0300-W	3.0	6.0	64.0	7.5	-	0.15
VMH 0400-W	4.0	6.0	64.0	10.0	-	0.2
VMH 0500-W	5.0	6.0	64.0	12.5	-	0.2
VMH 0600-W	6.0	6.0	64.0	15.0	-	0.2
VMH 06-1.0RW	6.0	6.0	64.0	15.0	1.0	-
VMH 0800-W	8.0	8.0	64.0	20.0	-	0.25
VMH 08-1.0RW	8.0	8.0	64.0	20.0	1.0	-
VMH 1000-W	10.0	10.0	73.0	25.0	-	0.3
VMH 10-1.0RW	10.0	10.0	73.0	25.0	1.0	-
VMH 1200-W	12.0	12.0	84.0	30.0	-	0.35
VMH 12-1.0RW	12.0	12.0	84.0	30.0	1.0	-
VMH 1600-W	16.0	16.0	93.0	40.0	-	0.4
VMH 16-1.0RW	16.0	16.0	93.0	40.0	1.0	-
VMH 2000-W	20.0	20.0	105.0	50.0	-	0.5
VMH 20-1.0RW	20.0	20.0	105.0	50.0	1.0	-



TuffCut® GP Series V4L

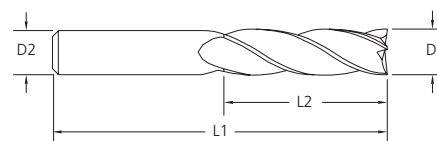
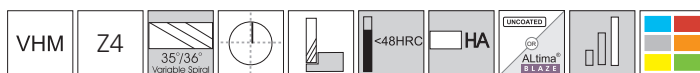

Series V4L		Tool Dimensions			
Uncoated	Coated	Ø D1	Ø D2	L1	L2
Tool No.	Tool No.				
V4L 0600	V4L 0600B	6.0	6.0	75.0	25.0
V4L 0800	V4L 0800B	8.0	8.0	75.0	25.0
V4L 1000	V4L 1000B	10.0	10.0	100.0	40.0
V4L 1200	V4L 1200B	12.0	12.0	100.0	50.0
V4L 1201	V4L 1201B	12.0	12.0	150.0	75.0
V4L 1600	V4L 1600B	16.0	16.0	150.0	75.0
V4L 2000	V4L 2000B	20.0	20.0	150.0	75.0



TuffCut® GP Series ASV4ACB

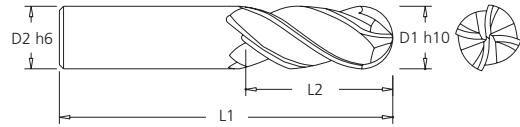
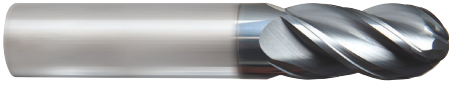
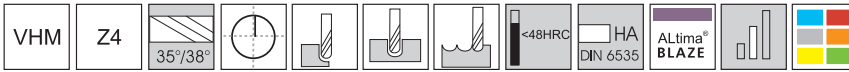

Series ASV4ACB	Tool Dimensions			
Tool No.	Ø D1	Ø D2	L1	L2
ASV4ACBNM0300	3.0	3.0	51.0	6.0
ASV4ACBNM0400	4.0	4.0	51.0	11.0
ASV4ACBNM0500	5.0	5.0	57.0	12.0
ASV4ACBNM0600	6.0	6.0	64.0	15.0
ASV4ACBNM0800	8.0	8.0	64.0	22.0
ASV4ACBNM1000	10.0	10.0	72.0	22.0
ASV4ACBNM1200	12.0	12.0	73.0	27.0
ASV4ACBNM1400	14.0	14.0	84.0	30.0
ASV4ACBNM1600	16.0	16.0	92.0	33.0
ASV4ACBNM2000	20.0	20.0	104.0	40.0



TuffCut® GP Series V4LB

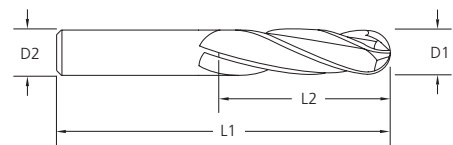
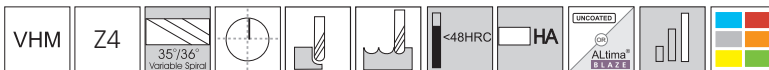

Series V4LB		Tool Dimensions			
Uncoated	Coated	Ø D1	Ø D2	L1	L2
Tool No.	Tool No.				
V4LB 0600	V4LB 0600B	6.0	6.0	75.0	25.0
V4LB 0800	V4LB 0800B	8.0	8.0	75.0	25.0
V4LB 1000	V4LB 1000B	10.0	10.0	100.0	40.0
V4LB 1200	V4LB 1200B	12.0	12.0	100.0	50.0
V4LB 1201	V4LB 1201B	12.0	12.0	150.0	75.0
V4LB 1600	V4LB 1600B	16.0	16.0	150.0	75.0
V4LB 2000	V4LB 2000B	20.0	20.0	150.0	75.0



TuffCut® GP Series GT2, GT3

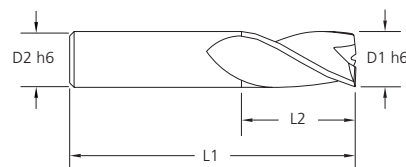
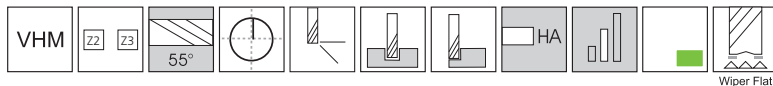

Series GT2	Series GT3	Tool Dimensions			
Tool No.	Tool No.	Ø D1	Ø D2	L1	L2
GT2 0100	-	1.0	3.0	50.0	5.0
GT2 0150	-	1.5	3.0	50.0	6.0
GT2 0200	-	2.0	3.0	50.0	7.0
GT2 0250	-	2.5	3.0	50.0	10.0
GT2 0300	GT3 0300	3.0	3.0	51.0	12.0
GT2 0400	GT3 0400	4.0	4.0	51.0	15.0
GT2 0500	GT3 0500	5.0	5.0	57.0	20.0
GT2 0600	GT3 0600	6.0	6.0	64.0	20.0
GT2 0800	GT3 0800	8.0	8.0	64.0	20.0
GT2 1000	GT3 1000	10.0	10.0	73.0	25.0
GT2 1200	GT3 1200	12.0	12.0	73.0	25.0
GT2 1400	GT3 1400	14.0	14.0	84.0	30.0
GT2 1600	GT3 1600	16.0	16.0	93.0	35.0
GT2 2000	GT3 2000	20.0	20.0	105.0	40.0



TuffCut® GP Series ASVSM

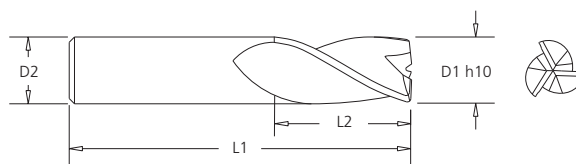
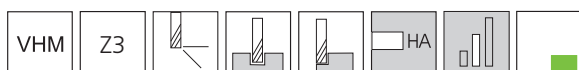

Series ASVSM	Tool Dimensions			
Tool No.	Ø D1	Ø D2	L1	L2
ASVSM0300	3.0	3.0	51.0	7.0
ASVSM0400	4.0	4.0	51.0	10.0
ASVSM0500	5.0	5.0	57.0	16.0
ASVSM0600	6.0	6.0	64.0	18.0
ASVSM0800	8.0	8.0	64.0	20.0
ASVSM1000	10.0	10.0	73.0	22.0
ASVSM1200	12.0	12.0	73.0	25.0
ASVSM1400	14.0	14.0	84.0	30.0
ASVSM1600	16.0	16.0	93.0	33.0
ASVSM2000	20.0	20.0	105.0	40.0



TuffCut® GP Series GT2R, GT3R

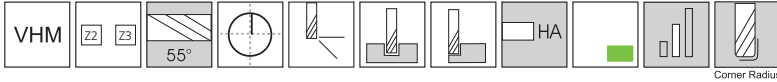

Z2



Z3

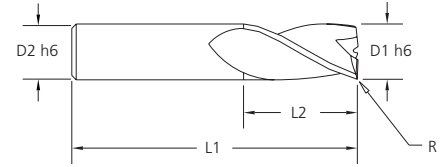

Series GT2R	Series GT3R	Tool Dimensions						
		Tool No.	Tool No.	Ø D1	Ø D2	L1	L2	R
-	GT3 0300-0.3R			3.0	3.0	51.0	12.0	0.3
-	GT3 0300-0.5R			3.0	3.0	51.0	12.0	0.5
GT2 0400-0.25R	GT3 0400-0.25R			4.0	4.0	51.0	15.0	0.25
GT2 0400-0.5R	GT3 0400-0.5R			4.0	4.0	51.0	15.0	0.5
GT2 0400-1.0R	GT3 0400-1.0R			4.0	4.0	51.0	15.0	1.0
GT2 0500-0.25R	GT3 0500-0.25R			5.0	5.0	57.0	20.0	0.25
GT2 0500-0.5R	GT3 0500-0.5R			5.0	5.0	57.0	20.0	0.5
GT2 0500-1.0R	GT3 0500-1.0R			5.0	5.0	57.0	20.0	1.0
-	GT3 0500-1.5R			5.0	5.0	57.0	20.0	1.5
GT2 0600-0.25R	GT3 0600-0.25R			6.0	6.0	64.0	20.0	0.25
GT2 0600-0.5R	GT3 0600-0.5R			6.0	6.0	64.0	20.0	0.5
GT2 0600-1.0R	GT3 0600-1.0R			6.0	6.0	64.0	20.0	1.0
GT2 0600-1.5R	GT3 0600-1.5R			6.0	6.0	64.0	20.0	1.5
GT2 0600-2.0R	GT3 0600-2.0R			6.0	6.0	64.0	20.0	2.0
GT2 0800-0.25R	GT3 0800-0.25R			8.0	8.0	64.0	20.0	0.25
GT2 0800-0.5R	GT3 0800-0.5R			8.0	8.0	64.0	20.0	0.5
GT2 0800-1.0R	GT3 0800-1.0R			8.0	8.0	64.0	20.0	1.0
GT2 0800-1.5R	GT3 0800-1.5R			8.0	8.0	64.0	20.0	1.5
GT2 0800-2.0R	GT3 0800-2.0R			8.0	8.0	64.0	20.0	2.0
GT2 0800-3.0R	GT3 0800-3.0R			8.0	8.0	64.0	20.0	3.0
GT2 1000-0.5R	GT3 1000-0.5R			10.0	10.0	73.0	25.0	0.5
GT2 1000-1.0R	GT3 1000-1.0R			10.0	10.0	73.0	25.0	1.0
-	GT3 1000-1.5R			10.0	10.0	73.0	25.0	1.5
GT2 1000-2.0R	GT3 1000-2.0R			10.0	10.0	73.0	25.0	2.0
GT2 1000-3.0R	-			10.0	10.0	73.0	25.0	3.0
GT2 1200-0.25R	-			12.0	12.0	73.0	25.0	0.25
GT2 1200-0.5R	GT3 1200-0.5R			12.0	12.0	73.0	25.0	0.5
GT2 1200-1.0R	GT3 1200-1.0R			12.0	12.0	73.0	25.0	1.0
GT2 1200-1.5R	GT3 1200-1.5R			12.0	12.0	73.0	25.0	1.5
GT2 1200-2.0R	GT3 1200-2.0R			12.0	12.0	73.0	25.0	2.0
GT2 1200-3.0R	GT3 1200-3.0R			12.0	12.0	73.0	25.0	3.0
-	GT3 1600-0.5R			16.0	16.0	93.0	35.0	0.5
GT2 1600-1.0R	GT3 1600-1.0R			16.0	16.0	93.0	35.0	1.0
-	GT3 1600-1.5R			16.0	16.0	93.0	35.0	1.5
GT2 1600-2.0R	GT3 1600-2.0R			16.0	16.0	93.0	35.0	2.0
-	GT3 1600-3.0R			16.0	16.0	93.0	35.0	3.0



TuffCut® GP Series GT2B, GT3B

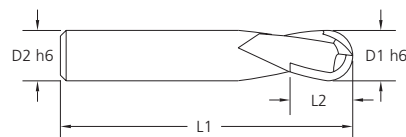
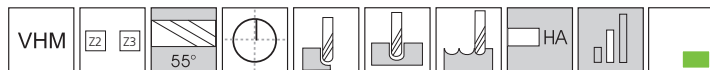

Series GT2B	Series GT3B	Tool Dimensions			
Tool No.	Tool No.	Ø D1	Ø D2	L1	L2
GT2B 0300	GT3B 0300	3.0	3.0	51.0	12.0
GT2B 0400	GT3B 0400	4.0	4.0	51.0	15.0
GT2B 0500	GT3B 0500	5.0	5.0	57.0	20.0
GT2B 0600	GT3B 0600	6.0	6.0	64.0	20.0
GT2B 0800	GT3B 0800	8.0	8.0	64.0	20.0
GT2B 1000	GT3B 1000	10.0	10.0	73.0	25.0
GT2B 1200	GT3B 1200	12.0	12.0	73.0	25.0
GT2B 1400	GT3B 1400	14.0	14.0	84.0	30.0
GT2B 1600	GT3B 1600	16.0	16.0	93.0	35.0
GT2B 2000	GT3B 2000	20.0	20.0	105.0	40.0



TuffCut® GP Series 134

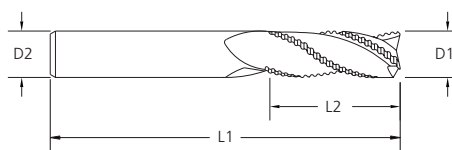
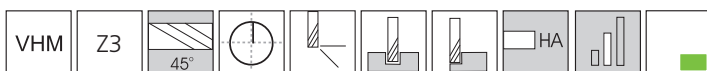

Series 134	Tool Dimensions			
Tool No.	Ø D1	Ø D2	L1	L2
134 0600	6.0	6.0	64.0	20.0
134 0800	8.0	8.0	64.0	20.0
134 1000	10.0	10.0	70.0	25.0
134 1200	12.0	12.0	76.0	25.0
134 1400	14.0	14.0	89.0	30.0
134 1600	16.0	16.0	89.0	30.0
134 1800	18.0	18.0	102.0	35.0
134 2000	20.0	20.0	102.0	38.0
134 2500	25.0	25.0	102.0	50.0



TuffCut® FORDMAX Carbide Endmills

Series 164, 169, 163, 166, 165, 121, 116, 111, 150, 140, V4L, V4LB

Recommended cutting data | Conditions de coupe recommandées | Empfohlene Schnittdaten | Dati di taglio Raccomandati | Zalecane Parametry

Tool Lengths	2 Flute (Z2)		3 Flute (Z3)		4 Flute (Z4)	
	GP Series		GP Series		GP Series	
Stub/Short	164	166	169	-	163 *	165 *
Standard	121	150	116	-	111 *	140 *
Long	-	-	-	-	V4L **	V4LB **

* Please Note - 4 Flute (Z4) Endmills Are Not Recommended For Full Diameter Engagement/Slotting Applications

** V4L & V4LB long series Endmills are for profile milling
For V4L & V4LB reduce speed by 20%
For V4L & V4LB - Maximum Radial Cut (Ae) = 0.01 x D

Please use lower Vc values shown for uncoated tools.
Please use higher Vc values shown for ALtima® coated tools

Cutting Speeds By Material Group				Feed Recommendations				
Workpiece Material Group	Material Type	Vc (m/min)	Tool Diameter (mm)					
			3.0	5.0	6.0	8.0	10.0	
			Feed/Tooth (fz - mm)					
Steels	P	Low Carbon	100 - 150	.013 - .020	.025 - .030	.038 - .051	.038 - .051	.053 - .076
		Medium Carbon	90 - 125					
		Mould/Tool Steel	60 - 75					
Stainless Steels	M	Free Machining	70 - 90	.013 - .020	.025 - .030	.038 - .051	.038 - .051	.053 - .076
		Ferritic	60 - 85					
		Austenitic	55 - 70					
		Martensitic	45 - 60					
		PH Stainless	40 - 50					
Cast Irons	K	Grey Cast Iron	120 - 140	.013 - .020	.025 - .030	.038 - .051	.038 - .051	.053 - .076
		Ductile Cast Iron	90 - 120					
		Malleable Iron	70 - 90					
Special Alloys	S	High Temp Alloys	10 - 20	.005 - .010	.005 - .012	.005 - .015	.015 - .030	.015 - .030
		Titanium Alloys	20 - 50					
Hardened Steels	H	35 - 45 HRC	60 - 75	.008 - .013	.010 - .030	.010 - .030	.025 - .050	.025 - .050
		45 - 55 Rc Steel	45 - 60					
Non-Ferrous	N	Aluminium Alloys	150 - 200	.020 - .040	.040 - .050	.050 - .060	.060 - .070	.070 - .080
		Brass / Bronze	120 - 180					
		Magnesium & Alloys	200 - 300					

RPM Formula For Metric Endmills - $RPM = (Vc \times 318.0) \div \text{Endmill } \varnothing$
Feedrate Formula For Metric Endmills - $\text{Feedrate} = RPM \times fz \times \text{Number Of Cutting Teeth}$

TuffCut® FORDMAX Carbide Endmills

Series 164, 169, 163, 166, 165, 121, 116, 111, 150, 140, V4L, V4LB

Recommended cutting data | Conditions de coupe recommandées | Empfohlene Schnittdaten | Dati di taglio Raccomandati | Zalecane Parametry

 Please use lower Vc values shown for uncoated tools.
 Please use higher Vc values shown for ALtima® coated tools.

Cutting Speeds By Material Group				Feed Recommendations			
Workpiece Material Group	Material Type	Vc (m/min)	Tool Diameter (mm)				
			12.0	16.0	20.0	25.0	
			Feed/Tooth (fz - mm)				
Steels	P	Low Carbon	100 – 150	.051 - .089	.058 - .102	.056 - .110	.080 - .130
		Medium Carbon	90 – 125				
		Mould/Tool Steel	60 - 75				
Stainless Steels	M	Free Machining	70 - 90	.051 - .089	.058 - .102	.056 - .110	.080 - .130
		Ferritic	60 - 85				
		Austenitic	55 - 70				
		Martensitic	45 - 60				
		PH Stainless	40 - 50				
Cast Irons	K	Grey Cast Iron	120 - 140	.051 - .089	.058 - .102	.056 - .109	.081 - .127
		Ductile Cast Iron	90 - 120				
		Malleable Iron	70 - 90				
Special Alloys	S	High Temp Alloys	10 - 20	.020 - .030	.030 - .040	.030 - .045	.045 - .050
		Titanium Alloys	20 - 50				
Hardened Steels	H	35 - 45 Hrc	60 - 75	.030 - .060	.050 - .070	.060 - .080	.070 - .090
		45 - 55 Rc Steel	45 - 60				
Non-Ferrous	N	Aluminium Alloys	150 - 200	.080 - .100	.100 - .200	.200 - .250	.200 - .250
		Brass / Bronze	120 - 180				
		Magnesium & Alloys	200 - 300				

 RPM Formula For Metric Endmills - $RPM = (Vc \times 318.0) \div \text{Endmill } \varnothing$

 Feedrate Formula For Metric Endmills - $\text{Feedrate} = RPM \times fz \times \text{Number Of Cutting Teeth}$

TuffCut® FORDMAX Carbide Endmills Series 192

Recommended cutting data | Conditions de coupe recommandées | Empfohlene Schnittdaten | Dati di taglio Raccomandati | Zalecane Parametry

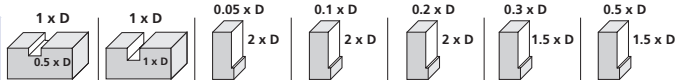
Workpiece Material Group	Material Type	Coolant										
		Max	Air	MMS	Vc (m/min)							
Steels	P	Low Carbon	●	●	●	210	210	450	450	350	300	250
		Medium Carbon	●	●	●	180	180	270	270	250	230	200
		Alloy Steels	●	●	●	160	160	250	250	230	210	180
		Die/Tool Steels	●	●	●	130	130	225	225	200	170	130
Stainless Steels	M	Free Machining	●	-	○	110	110	150	150	130	120	105
		Austenitic	●	-	○	100	100	130	130	120	110	100
		Difficult Stainless	●	-	○	70	70	100	100	90	80	70
		PH Stainless	●	-	○	100	100	130	130	120	110	100
		Cobalt Chrome Alloys	●	-	○	70	70	100	100	90	80	70
		Duplex (22%)	●	-	○	70	70	100	100	90	80	70
		Super Duplex (25%)	●	-	○	50	50	60	60	55	50	45
Cast Irons	K	Grey Cast Iron	●	○	○	180	180	360	360	340	240	190
		Ductile Cast Iron	●	○	○	170	170	270	270	240	190	170
		Malleable Iron	●	○	○	130	130	160	160	150	140	130
Special Alloys	S	High Temp Alloys	●	-	-	30	30	50	50	40	35	30
		Inconel	●	-	-	30	30	50	50	40	35	30
		Titanium Alloys	●	-	-	70	70	120	120	110	90	75
Hardened Steels	H	Hardened Steels 45 - 50 Rc	●	○	○	55	55	135	135	125	90	50
		Hardened Steels 50 - 55 Rc	●	○	○	45	45	115	115	105	75	45

● Preferred ○ Possible x Not Possible

TuffCut® FORDMAX Carbide Endmills

Series 192

Recommended cutting data · Conditions de coupe recommandées · Empfohlene Schnittdaten · Dati di taglio Raccomandati · Zalecane Parametry

Workpiece Material Group		Type of Machining	Tool Diameter					
			6mm	8mm	10mm	12mm	16mm	20mm
			Feed/Tooth (fz - mm)					
Steels	P	Profiling	0.085	0.100	0.120	0.170	0.200	0.230
		Slotting	0.043	0.050	0.060	0.085	0.100	0.125
Stainless Steels	M	Profiling	0.085	0.100	0.120	0.170	0.200	0.230
		Slotting	0.043	0.050	0.060	0.085	0.100	0.125
		Profiling	0.064	0.076	0.086	0.125	0.150	0.175
		Slotting	0.032	0.038	0.045	0.060	0.075	0.085
Cast Irons	K	Profiling	0.085	0.100	0.120	0.170	0.200	0.230
		Slotting	0.043	0.050	0.060	0.085	0.100	0.125
Special Alloys	S	Profiling	0.043	0.050	0.060	0.085	0.100	0.120
		Slotting	0.022	0.025	0.030	0.045	0.050	0.060
		Profiling	0.085	0.100	0.120	0.170	0.200	0.230
		Slotting	0.022	0.025	0.030	0.045	0.050	0.060
Hardened Steels	H	Profiling	0.076	0.090	0.100	0.150	0.180	0.200
		Slotting	0.035	0.045	0.050	0.075	0.090	0.100
		Profiling	0.053	0.066	0.076	0.100	0.132	0.155
		Slotting	0.025	0.033	0.036	0.050	0.065	0.080

 RPM Formula For Metric Endmills - $RPM = (Vc \times 318.0) \div \text{Endmill } \varnothing$

 Feedrate Formula For Metric Endmills - $\text{Feedrate} = RPM \times fz \times \text{Number Of Cutting Teeth}$

TuffCut® FORDMAX Carbide Endmills Series VMH, ASV4, MV4

Recommended cutting data | Conditions de coupe recommandées | Empfohlene Schnittdaten | Dati di taglio Raccomandati | Zalecane Parametry

Workpiece Material Group	Material Type	Coolant			1 x D 0.5 x D	1 x D 1 x D	0.05 x D 2 x D	0.1 x D 2 x D	0.2 x D 2 x D	0.3 x D 1.5 x D	0.5 x D 1.5 x D	
		Max	Air	MMS	Vc-M/Min							
Steels	P	Low Carbon	●	●	●	230	220	480	385	330	275	220
		Medium Carbon	●	●	●	200	185	345	275	255	220	185
		Alloy Steels	●	●	●	175	165	315	255	230	200	165
		Die/Tool Steels	●	●	●	145	130	275	220	187	145	130
Stainless Steels	M	Free Machining	●	X	○	120	110	205	165	130	115	110
		Austenitic	●	X	○	110	100	160	130	120	110	100
		Difficult Stainless	●	X	○	75	65	125	100	90	75	65
		PH Stainless	●	X	○	110	100	160	130	120	110	100
		Cobalt Chrome Alloys	●	X	○	75	65	125	100	90	75	65
		Duplex (22%)	●	X	○	75	65	125	100	90	75	65
Super Duplex (25%)	●	X	○	55	45	75	60	55	50	45		
Cast Irons	K	Gray Cast Iron	●	○	○	200	175	495	395	265	210	175
		Ductile Cast Iron	●	○	○	185	165	370	300	210	185	165
		Malleable Iron	●	○	○	145	132	205	165	155	145	130
Special Alloys	S	High Temp Alloys	●	X	X	35	28	55	45	40	35	28
		Titanium Alloys	●	X	X	35	28	55	45	40	35	28
Hardened Steels	H	Hardened Steels 35 - 45 Rc	●	○	○	60	50	185	150	100	55	50
		Hardened Steels 45 - 55 Rc	●	○	○	50	45	155	125	85	50	45

● Preferred ○ Possible X Not Possible

TuffCut® FORDMAX Carbide Endmills

Series VMH, ASV4, MV4

Recommended cutting data · Conditions de coupe recommandées · Empfohlene Schnittdaten · Dati di taglio Raccomandati · Zalecane Parametry

Workpiece Material Group	Type of Machining	Tool Diameter								
		3mm	5mm	6mm	8mm	10mm	12mm	16mm	20mm	
		Feed/Tooth (fz - mm)								
Steels	P	Profiling	0.030	0.050	0.060	0.080	0.100	0.120	0.160	0.200
		Slotting	0.015	0.025	0.030	0.040	0.050	0.060	0.080	0.100
Stainless Steels	M	Profiling	0.030	0.050	0.060	0.080	0.100	0.120	0.160	0.200
		Slotting	0.015	0.025	0.030	0.040	0.050	0.060	0.080	0.100
Cast Irons	K	Profiling	0.030	0.050	0.060	0.080	0.100	0.120	0.160	0.200
		Slotting	0.015	0.025	0.030	0.040	0.050	0.060	0.080	0.100
High Temp Alloys	S	Profiling	0.009	0.013	0.032	0.038	0.044	0.064	0.076	0.089
		Slotting	0.005	0.007	0.016	0.019	0.022	0.032	0.038	0.045
Titanium	S	Profiling	0.030	0.050	0.060	0.080	0.100	0.120	0.160	0.200
		Slotting	0.015	0.025	0.030	0.040	0.050	0.060	0.080	0.100
Hardened Steels	H	Profiling 35 - 45 Rc	0.016	0.023	0.057	0.069	0.080	0.114	0.137	0.160
		Slotting 35 - 45 Rc	0.010	0.015	0.025	0.035	0.045	0.065	0.070	0.075
		Profiling 45 - 55 Rc	0.010	0.015	0.041	0.051	0.058	0.084	0.102	0.119
		Slotting 45 - 55 Rc	0.008	0.011	0.020	0.030	0.040	0.050	0.055	0.080



 RPM Formula For Metric Endmills - $RPM = (Vc \times 318.0) \div \text{Endmill } \varnothing$



 Feedrate Formula For Metric Endmills - $\text{Feedrate} = RPM \times fz \times \text{Number Of Cutting Teeth}$

TuffCut® FORDMAX Carbide Endmills Series 134

Recommended cutting data | Conditions de coupe recommandées | Empfohlene Schnittdaten | Dati di taglio Raccomandati | Zalecane Parametry

Material Group		
Workpiece Material		Material Type
Non Ferrous	N	Aluminium/Aluminium Alloys ≤ 10% Si

Series	Type Of Cut	ap	ae	Vc (m/min)	Tool Diameter (mm)				
					6.0	8.0	10.0	12.0	16.0
					Feed/Tooth (fz - mm)				
134	 Slotting	0.5 x D	1 x D	300 - 500	0.06	0.08	0.09	0.12	0.17
		1 x D	1 x D	300 - 500	0.05	0.07	0.08	0.10	0.15
	 Profiling	1 x D	0.2 x D	300 - 500	0.07	0.12	0.13	0.15	0.20
		1 x D	0.5 x D	300 - 500	0.06	0.08	0.09	0.12	0.17

Series	Type Of Cut	ap	ae	Vc (m/min)	Tool Diameter (mm)	
					20.0	25.0
					Feed/Tooth (fz - mm)	
134	 Slotting	0.5 x D	1 x D	300 - 500	0.20	0.25
		1 x D	1 x D	300 - 500	0.15	0.20
	 Profiling	1 x D	0.2 x D	300 - 500	0.22	0.28
		1 x D	0.5 x D	300 - 500	0.20	0.25

RPM Formula For Metric Endmills - $RPM = (Vc \times 318.0) \div \text{Endmill } \varnothing$

Feedrate Formula For Metric Endmills - $\text{Feedrate} = RPM \times fz \times \text{Number Of Cutting Teeth}$.

TuffCut® FORDMAX Carbide Endmills

Series GT2 GT3 & GT2B GT3B, ASVSM

Recommended cutting data · Conditions de coupe recommandées · Empfohlene Schnittdaten · Dati di taglio Raccomandati · Zalecane Parametry

Material Group		
Workpiece Material	Material Type	
Non Ferrous	N	Aluminium/Aluminium Alloys

Series	Type Of Cut	ap	ae	Vc (m/min)	Tool Diameter (mm)				
					3.0	4.0	5.0	6.0	8.0
					Feed/Tooth (fz - mm)				
GT2 & GT3 GT2B & GT3B	Slotting	0.5 x D	1 x D	300 - 500	0.02	0.03	0.04	0.05	0.07
	Profiling	1 x D	0.2 x D	300 - 500	0.03	0.045	0.06	0.075	0.105
		1 x D	0.5 x D	300 - 500	0.02	0.03	0.04	0.05	0.07

Series	Type Of Cut	ap	ae	Vc (m/min)	Tool Diameter (mm)				
					10.0	12.0	14.0	16.0	20.0
					Feed/Tooth (fz - mm)				
GT2 & GT3 GT2B & GT3B	Slotting	0.5 x D	1 x D	300 - 500	0.10	0.12	0.15	0.16	0.20
	Profiling	1 x D	0.2 x D	300 - 500	0.15	0.18	0.225	0.24	0.30
		1 x D	0.5 x D	300 - 500	0.10	0.12	0.15	0.16	0.20

 RPM Formula For Metric Endmills - $RPM = (Vc \times 318.0) \div \text{Endmill } \varnothing$

 Feedrate Formula For Metric Endmills - $\text{Feedrate} = RPM \times fz \times \text{Number Of Cutting Teeth}$

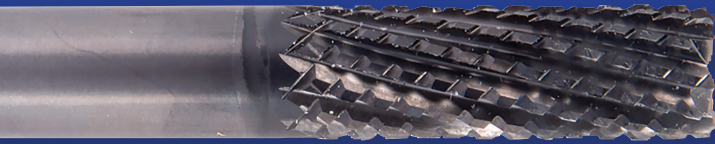

Diamond Grind Routers

'The "Black" Diamond'

Designed specifically for the high performance machining of aerospace composites, the 239 Series combines our advanced 'Black Diamond GemX' coating and an application specific carbide substrate, together with specially designed rake angles and flute structures, to deliver increased routing rates while removing the risk of delamination and flaking.

(FR)

« Conçues spécifiquement pour l'usinage haute performance de composites aéronautiques, les gammes 239 combinent notre revêtement à technologie avancée « Black Diamond GemX » avec un substrat de carbure spécifique, allié à des angles de coupe et formes de goujure spécialement conçus pour augmenter les prises de passe, tout en éliminant les risques de délaminage et d'écaillage. »

(DE)

Die Produktreihe 239 wurde speziell für die Hochleistungsbearbeitung von Verbundstoffen der Luft- und Raumfahrt konzipiert. Sie vereint unsere fortschrittliche „Black Diamond GemX“-Beschichtung sowie ein anwendungsspezifisches Hartmetallsubstrat mit speziell ausgelegten Spanwinkeln und Schneidenstrukturen für erhöhte Fräsgeschwindigkeiten bei gleichzeitiger Beseitigung eines Risikos von Schichtablösung und Abplatzung.

(IT)

Specifica per lavorazioni ad alte prestazioni su compositi aerospaziali, la Serie 239 è una combinazione di tecnologie avanzate: il rivestimento evoluto "Black Diamond GemX", lo specifico substrato in metallo duro, la geometria dei taglienti e la struttura delle gole appositamente studiati per permettere lavorazioni ad alto avanzamento senza delaminazione o sfaldatura.

(PL)

Zaprojektowany specjalnie do wysokowydajnej obróbki kompozytów lotniczych. Seria 239 łączy naszą zaawansowaną powłokę 'Black Diamond GemX' z podłożem ze spiekanego węgla wraz z unikalnymi kątami natarcia i strukturami rowkowymi w celu zwiększenia szybkości trasowania przy jednoczesnym zmniejszeniu ryzyka rozwarstwienia i łuszczenia.

- Fraises diamant pour composites
- Diamant-Oberfräsen
- Router con taglio a diamante
- Piłnik obrotowy z pokryciem diamentowym

	Page
Diamond Grind Routers	
Series 239 'The "Black" Diamond	108
Technical Information	109



Diamond Grind Routers Series 239 'The "Black" Diamond'

GemX Coating

- Microhardness (HV) – 10,000
- Maximum Service Temp. 600° C / 1100° F
- Friction Coefficient 0.10

Features

- GemX coating
- Unique carbide substrate
- Specially treated cutting edges

Benefits

- Longer tool life
- Faster cycle times
- No delamination or flaking
- Great edge quality
- Excellent for composite materials and fiberglass

Applications

- Trimming
- Routing
- Pocketing
- Interpolation of holes
- Low plastic content CFRP

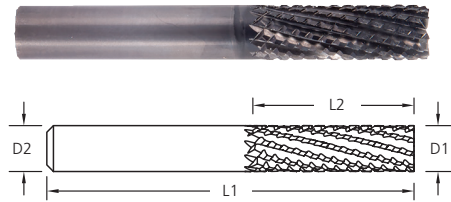
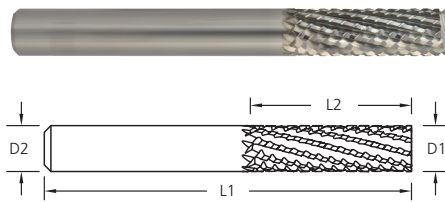

Tool No.	D1	D2	L1	L2	# Flutes (RHC)	End cut
239M0300	3.0	3.0	38.0	12.0	6	Safe End
239M0300B	3.0	3.0	38.0	12.0	6	Burr
239M0300E	3.0	3.0	38.0	12.0	6	End Mill
239M0300F	3.0	3.0	38.0	12.0	6	Fishtail
239M0400	4.0	4.0	50.0	15.0	6	Safe End
239M0400B	4.0	4.0	50.0	15.0	6	Burr
239M0400E	4.0	4.0	50.0	15.0	6	End Mill
239M0400F	4.0	4.0	50.0	15.0	6	Fishtail
239M0500	5.0	5.0	50.0	20.0	6	Safe End
239M0500B	5.0	5.0	50.0	20.0	6	Burr
239M0500E	5.0	5.0	50.0	20.0	6	End Mill
239M0500F	5.0	5.0	50.0	20.0	6	Fishtail
239M0600	6.0	6.0	63.0	20.0	10	Safe End
239M0600B	6.0	6.0	63.0	20.0	10	Burr
239M0600E	6.0	6.0	63.0	20.0	10	End Mill
239M0600F	6.0	6.0	63.0	20.0	10	Fishtail
239M0601	6.0	6.0	75.0	25.0	10	Safe End
239M0601B	6.0	6.0	75.0	25.0	10	Burr
239M0601E	6.0	6.0	75.0	25.0	10	End Mill
239M0601F	6.0	6.0	75.0	25.0	10	Fishtail
239M0800	8.0	8.0	75.0	25.0	10	Safe End
239M0800B	8.0	8.0	75.0	25.0	10	Burr
239M0800E	8.0	8.0	75.0	25.0	10	End Mill
239M0800F	8.0	8.0	75.0	25.0	10	Fishtail
239M1000	10.0	10.0	90.0	30.0	12	Safe End
239M1000B	10.0	10.0	90.0	30.0	12	Burr
239M1000E	10.0	10.0	90.0	30.0	12	End Mill
239M1000F	10.0	10.0	90.0	30.0	12	Fishtail

Tool No.	D1	D2	L1	L2	# Flutes (RHC)	End cut
239M1200	12.0	12.0	100.0	40.0	14	Safe End
239M1200B	12.0	12.0	100.0	40.0	14	Burr
239M1200E	12.0	12.0	100.0	40.0	14	End Mill
239M1200F	12.0	12.0	100.0	40.0	14	Fishtail
239M0300BGX	3.0	3.0	38.0	12.0	6	Burr
239M0300EGX	3.0	3.0	38.0	12.0	6	End Mill
239M0300FGX	3.0	3.0	38.0	12.0	6	Fishtail
239M0400BGX	4.0	4.0	50.0	15.0	6	Burr
239M0400EGX	4.0	4.0	50.0	15.0	6	End Mill
239M0400FGX	4.0	4.0	50.0	15.0	6	Fishtail
239M0500BGX	5.0	5.0	50.0	20.0	6	Burr
239M0500EGX	5.0	5.0	50.0	20.0	6	End Mill
239M0500FGX	5.0	5.0	50.0	20.0	6	Fishtail
239M0600BGX	6.0	6.0	63.0	20.0	10	Burr
239M0600EGX	6.0	6.0	63.0	20.0	10	End Mill
239M0600FGX	6.0	6.0	63.0	20.0	10	Fishtail
239M0601BGX	6.0	6.0	75.0	25.0	10	Burr
239M0601EGX	6.0	6.0	75.0	25.0	10	End Mill
239M0601FGX	6.0	6.0	75.0	25.0	10	Fishtail
239M0800BGX	8.0	8.0	75.0	25.0	10	Burr
239M0800EGX	8.0	8.0	75.0	25.0	10	End Mill
239M0800FGX	8.0	8.0	75.0	25.0	10	Fishtail
239M1000BGX	10.0	10.0	90.0	30.0	12	Burr
239M1000EGX	10.0	10.0	90.0	30.0	12	End Mill
239M1000FGX	10.0	10.0	90.0	30.0	12	Fishtail
239M1200BGX	12.0	12.0	100.0	40.0	14	Burr
239M1200EGX	12.0	12.0	100.0	40.0	14	End Mill
239M1200FGX	12.0	12.0	100.0	40.0	14	Fishtail

M.A. Ford® has an agreement with The Boeing Company and has been granted license rights to use Boeing patents and proprietary data.



Diamond Grind Routers Series 239 'The "Black" Diamond'

Recommended cutting data | Conditions de coupe recommandées | Empfohlene Schnittdaten | Dati di taglio Raccomandati | Zalecane dane o Cięciu

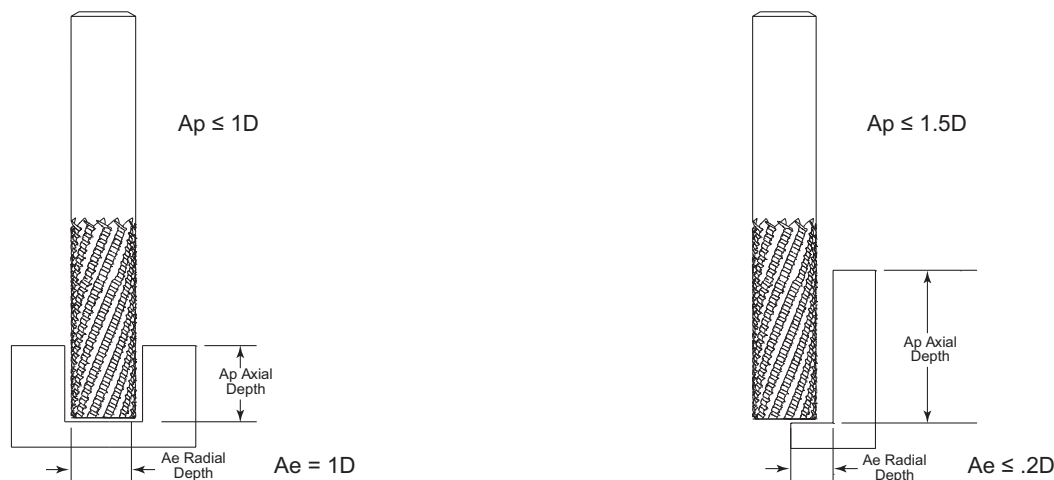

Slotting 90 (m/min)		
Tool Diameter	RPM	mm/min
3.0	9000	254
5.0	6000	304
6.0	5000	381
8.0	4000	457
10.0	3000	508
12.0	2000	635

Slotting 182 (m/min)		
Tool Diameter	RPM	mm/min
3.0	18000	508
5.0	12000	635
6.0	9000	762
8.0	7000	889
10.0	6000	1016
12.0	5000	1270

Feed adjustment to part thickness	
≤ 0.5D	x 150%
0.5D - 1D	x 120%
1D - 2D	x 80%
3D-4D	x 50%

Side Milling 120(m/min)		
Tool Diameter	RPM	mm/min
3.0	12000	508
5.0	8000	635
6.0	6000	762
8.0	5000	889
10.0	4000	1016
12.0	3000	1270

Side Milling 240 (m/min)		
Tool Diameter	RPM	mm/min
3.0	24000	1016
5.0	16000	1270
6.0	12000	1524
8.0	10000	1778
10.0	8000	2032
12.0	6000	2540

EN

** Tool must have end grind in order to slot.

Note: The parameters in this table are for common material thickness of 6mm. You must use the Radial Depth (Ae) of 20% or less for Side Milling. For best surface finish conventional mill is recommended. Higher feed rates are possible but surface finish may change.

Technical data provided should be considered advisory only as variations may be necessary depending on the particular application.

FR

*** L'outil doit avoir une coupe en bout pour le rainage.

À noter: Les paramètres de ce tableau peuvent s'appliquer aux matériaux ordinaires d'une épaisseur de 6mm. Vous devez prévoir un engagement (Ae) inférieur ou égal à 20% du diamètre pour un contournage. Pour obtenir un meilleur état de surface, une fraise conventionnelle est recommandée. Des vitesses d'avance plus élevées sont possibles mais l'état de surface risque de changer.

Les données techniques sont seulement fournies à titre indicatif, étant donné que des variations peuvent s'avérer nécessaires en fonction de l'application donnée."

DE

** Werkzeug muss an Nute angeschliffenes Ende aufweisen.

Hinweis: Die Parameter in dieser Tabelle beziehen sich auf eine allgemeine Materialstärke von 6 mm. Beim Scheibenfräsen müssen Sie eine Radialtiefe (Ae) von höchstens 20 % verwenden. Zum Erzielen der besten Oberflächengüte wird ein herkömmlicher Fräser empfohlen. Es sind höhere Vorschubgeschwindigkeiten möglich. Die Oberflächengüte kann sich dadurch jedoch ändern.

Die aufgeführten technischen Daten sollten nur als Empfehlung angesehen werden, da in Abhängigkeit von bestimmten Anwendungen Änderungen erforderlich sein können.

IT

** L'utensile deve avere il tagliente in testa per operazioni di scanalatura.

Nota: I parametri riportati in tabella si riferiscono a uno spessore convenzionale di 6 mm. È necessario utilizzare un impegno radiale (Ae) del 20% o inferiore in contornatura. Per una migliore finitura superficiale è consigliata la fresatura in discordanza. È possibile aumentare l'avanzamento ma la finitura superficiale potrebbe cambiare.

I dati tecnici forniti devono essere considerati orientativi, potrebbero essere necessari aggiustamenti a seconda della particolare applicazione.

PL

** Przy operacji rowkowania, narzędzie musi mieć czoło z ostrzem centralnym.

Uwaga: Parametry w tabeli podane są dla materiałów o grubości 6 mm. Należy użyć głębokości promieniowej (Ae) 20% lub mniej dla bocznego frezowania. Dla lepszego wykończenia powierzchni zalecana jest konwencjonalna frezarka. Wyższe wartości posuwu są możliwe, ale wykończenie powierzchni może się zmienić.

Podane dane techniczne należy traktować tylko jako poglądowe, ponieważ mogą wystąpić różnice w zależności od konkretnego zastosowania.



M.A. FordMax diamond grind routers provide an effective, high performance solution for routing glass reinforced PCB's, phenolic epoxy composites together with a range of other composite materials and plastics. Available as standard uncoated tools or incorporating the advanced ceramic CERAedge™ coating, which delivers outstanding performance and tool life, five different down-cut geometries are included in the range for maximum versatility.

(FR)

“Les fraise diamant M.A.FordMax fournissent une solution efficace et performante pour l'ébauche des PCB renforcés en fibre de verre, des composites époxydes phénoliques ainsi qu'une gamme d'autres matériaux composites et de matières plastiques. Les outils non revêtus standard ou intégrant le revêtement en céramique avancé CERAedge™, qui offre des performances exceptionnelles et une longue durée de vie, cinq géométries différentes sont incluses dans la gamme pour une polyvalence maximale.”

(DE)

M.A.FordMax Fräser für Verbundwerkstoffe bieten eine effektive, leistungsstarke Lösung für die Verlegung von glasverstärkten Leiterplatten, Phenol-Epoxid-Verbundwerkstoffen zusammen mit einer Reihe von anderen Verbundwerkstoffen und Kunststoffen. Als Standard-unbeschichtete Werkzeuge erhältlich oder mit der fortschrittlichen Keramik-CERAedge™ Beschichtung, die eine hervorragende Leistung und Werkzeuglebensdauer bietet, sind fünf verschiedene Down-Cut-Geometrien im Bereich für maximale Vielseitigkeit enthalten.

(IT)

I router con taglio a diamante M.A.FordMax forniscono una soluzione efficace, ad alte prestazioni, per la lavorazione di PCB rinforzati con fibra di vetro, compositi di resine fenoliche ed epossidiche, ed una vasta gamma di compositi e materie plastiche. Sono disponibili come standard nudi o con l'esclusivo rivestimento ceramico CERAedge™, che consente di ottenere prestazioni eccezionali e lunga vita utensile. Per la massima versatilità vengono prodotti con cinque diverse affilature di testa.

(PL)

Pilniki obrotowe z pokryciem diamentowym M.A.FordMax zapewniają skuteczne, wydajne rozwiązania do trasowania płyt warstwowych wzmocnionych włóknami szklanymi, kompozytów fenolowych epoksydów wraz z wieloma innymi materiałami kompozytowymi i tworzywami sztucznymi. Dostępne jako standardowe niepowlekane narzędzia jak również wyposażone w zaawansowaną ceramiczną powłokę CERAedge™, która zapewnia znakomitą wydajność i żywotność narzędzia. W zakresie maksymalnej uniwersalności uwzględniono pięć różnych geometrycznych kształtów.

Diamond Grind Routers

- ... Fraises diamant pour composites
- ... Diamant-Oberfräsen
- ... Router con taglio a diamante
- ... Pilnik obrotowy z pokryciem diamentowym

Page

Diamond Grind Routers

Standard Uncoated

Series 230	
Series 231	111
Series 231B	
Series 231D	
Series 231F	

Diamond Grind Routers

CERAedge® Coating

Series 230CE CERAedge®	
Series 231CE CERAedge®	111
Series 231BCE CERAedge®	
Series 231DCE CERAedge®	

Technical Information

112

Diamond Grind Routers Series 230 & 231

Standard Uncoated



Series 230 Down Cut
Safe End



Series 231 Down Cut
End Mill



Series 231B Down Cut
Burr End



Series 231D Down Cut
Drill Point



Series 231F Down Cut
Fishtail

Ø D1	Ø D2	L1	L2
0.8	3.175	38.0	3.0
1.0	3.175	38.0	4.0
1.2	3.175	38.0	4.0
1.5	3.175	38.0	5.0
1.6	3.175	38.0	5.0
2.0	3.175	38.0	8.0
2.4	3.175	38.0	9.5
3.0	3.0	38.0	12.5
5.0	5.0	51.0	16.0
6.0	6.0	51.0	19.0
8.0	8.0	64.0	22.0

CERAEdge™ Coating



Series 230CE CERAEdge®
Down Cut Safe End



Series 231CE CERAEdge®
Down Cut End Mill



Series 231BCE CERAEdge®
Down Cut Burr End



Series 231DCE CERAEdge®
Down Cut Drill Point

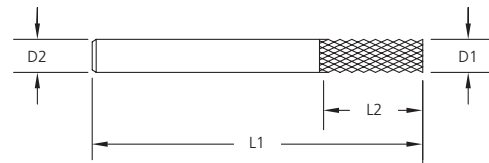

CERAEdge™ Coating

- Diamond grind designed for routing glass-reinforced printed circuit boards, phenolic-epoxy, composites and other highly abrasive materials.
- Available with a non-cutting safe end, or in three popular end-cutting styles with down cut geometries.

Diameter mm	Series 230	Series 230CE	Series 231	Series 231CE	Series 231B	Series 231BCE	Series 231D	Series 231DCE	Series 231F
0.8	230 0080	-	231 0080	-	231 0080B	-	231 0080D	-	231 0080F
1.0	230 0100	-	231 0100	-	231 0100B	-	231 0100D	-	231 0100F
1.2	230 0120	-	231 0120	-	231 0120B	-	231 0120D	-	231 0120F
1.5	230 0150	-	231 0150	-	231 0150B	-	231 0150D	-	231 0150F
1.6	230 0160	-	231 0160	-	231 0160B	-	-	-	231 0160F
2.0	230 0200	-	231 0200	-	231 0200B	-	231 0200D	-	231 0200F
2.4	230 0240	-	231 0240	-	231 0240B	-	231 0240D	-	231 0240F
3.0	230 0300	230 0300CE	231 0300	231 0300CE	231 0300B	231 0300BCE	231 0300D	231 0300DCE	231 0300F
5.0	230 0500	-	231 0500	231 0500CE	231 0500B	231 0500BCE	231 0500D	231 0500DCE	231 0500F
6.0	230 0600	230 0600CE	231 0600	231 0600CE	231 0600B	231 0600BCE	231 0600D	231 0600DCE	231 0600F
8.0	230 0800	-	231 0800	-	231 0800B	-	231 0800D	-	231 0800F



Diamond Grind Routers Series 230 & 231 Recommended cutting data

Conditions de coupe recommandées :: Empfohlene Schnittdaten :: Dati di taglio Raccomandati :: Zalecane dane o Cięciu

Slotting 90 (m/min)			Slotting 182 (m/min)		
Tool Diameter	RPM	mm/min	Tool Diameter	RPM	mm/min
0.8	35000	141	0.8	72000	289
1.0	28000	226	1.0	57000	463
1.2	23000	306	1.2	48000	627
1.5	18000	376	1.5	38000	771
1.6	17000	388	1.6	36000	795
2.0	14000	423	2.0	28000	868
2.4	11000	447	2.4	24000	916
3.0	9400	480	3.0	19000	984
5.0	5600	395	5.0	11000	810
6.0	4700	423	6.0	9600	868
8.0	3500	353	8.0	7200	723

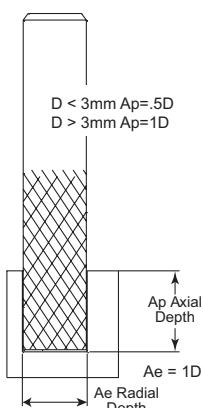

Side Milling 120(m/min)			Side Milling 240 (m/min)		
Tool Diameter	RPM	mm/min	Tool Diameter	RPM	mm/min
0.8	47000	190	0.8	95000	381
1.0	38000	305	1.0	76000	610
1.2	31000	413	1.2	63000	826
1.5	25000	508	1.5	50000	1017
1.6	23000	524	1.6	47000	1049
2.0	19000	572	2.0	38000	1145
2.4	15000	604	2.4	31000	1208
3.0	12000	648	3.0	25000	1297
5.0	7600	534	5.0	15000	1068
6.0	6300	572	6.0	12000	1145
8.0	4700	477	8.0	9500	954

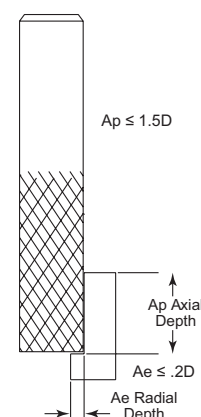
EN

** Tool must have end grind in order to slot.

Note: The parameters in this table are for common material thickness of 6mm. You must use the Radial Depth (Ae) of 20% or less for Side Milling. For best surface finish conventional mill is recommended. Higher feed rates are possible but surface finish may change.

Technical data provided should be considered advisory only as variations may be necessary depending on the particular application.

FR

** L'outil doit avoir une coupe en bout pour le rainurage.

À noter: Les paramètres de ce tableau peuvent s'appliquer aux matériaux ordinaires d'une épaisseur de 6mm. Vous devez prévoir un engagement (Ae) inférieur ou égal à 20% du diamètre pour un contournage. Pour obtenir un meilleur état de surface, une fraise conventionnelle est recommandée. Des vitesses d'avance plus élevées sont possibles mais l'état de surface risque de changer.

Les données techniques sont seulement fournies à titre indicatif, étant donné que des variations peuvent s'avérer nécessaires en fonction de l'application donnée.

DE

** Werkzeug muss an Nute angeschliffenes Ende aufweisen.

Hinweis: Die Parameter in dieser Tabelle beziehen sich auf eine allgemeine Materialstärke von 6 mm. Beim Scheibenfräsen müssen Sie eine Radialtiefe (Ae) von höchstens 20 % verwenden. Zum Erzielen der besten Oberflächengüte wird ein herkömmlicher Fräser empfohlen. Es sind höhere Vorschubgeschwindigkeiten möglich. Die Oberflächengüte kann sich dadurch jedoch ändern.

Die aufgeführten technischen Daten sollten nur als Empfehlung angesehen werden, da in Abhängigkeit von bestimmten Anwendungen Änderungen erforderlich sein können.

IT

** L'utensile deve avere il tagliente in testa per operazioni di scanalatura.

Nota: I parametri riportati in tabella si riferiscono a uno spessore convenzionale di 6 mm. È necessario utilizzare un impegno radiale (Ae) del 20% o inferiore in contornatura. Per una migliore finitura superficiale è consigliata la fresatura in discordanza. È possibile aumentare l'avanzamento ma la finitura superficiale potrebbe cambiare.

I dati tecnici forniti devono essere considerati orientativi, potrebbero essere necessari aggiustamenti a seconda della particolare applicazione.

PL

** Przy operacji rowkowania, narzędzie musi mieć czóło z ostrzem centralnym.

Uwaga: Parametry w tabeli podane są dla materiałów o grubości 6 mm. Należy użyć głębokości promieniowej (Ae) 20% lub mniej dla bocznego frezowania. Dla lepszego wykończenia powierzchni zalecana jest konwencjonalna frezarka. Wyższe wartości posuwu są możliwe, ale wykończenie powierzchni może się zmienić.

Podane dane techniczne należy traktować tylko jako poglądowe, ponieważ mogą wystąpić różnice w zależności od konkretnego zastosowania.



Twister® & CYCLONE

Our high performance Twister® and Cyclone drill ranges deliver extreme performance, penetration rates and outstanding hole finish on a wide range of materials from titanium, stainless steels and high temperature alloys through to aluminium and other non-ferrous metals.

(FR)

“Nos gammes de forets haute performance Twister® et Cyclone offrent des résultats exceptionnels, des vitesses d’avance et une qualité de trous remarquables sur un vaste éventail de matériaux comme le titane, les aciers inoxydables et les alliages à haute température ainsi que l’aluminium et les autres métaux non-ferreux.”

(DE)

Unser Hochleistungssortiment der Twister®- und Cyclone-Bohrer bieten höchste Leistungsfähigkeit, außergewöhnliche Bohrgeschwindigkeit und hervorragende Oberflächengüte der Bohrungen bei einem breiten Spektrum an Werkstoffen, von Titan, rostfreiem Stahl sowie hochtemperaturfesten Legierungen über Aluminium bis zu anderen, Nichteisenmetallen.

(IT)

Le nostre linee di punte ad alte prestazioni Twister® e Cyclone offrono estremo rendimento, capacità di penetrazione e straordinaria finitura del foro su una vasta gamma di materiali come titanio, acciai inossidabili e leghe ad alta temperatura, alluminio e altri metalli non ferrosi.

(PL)

Nasze wysokowydajne wiertła Twister® i Cyclone zapewniają ekstremalne osiągi, prędkość zagłębiania się i doskonałe wykończenie otworów w szerokim zakresie materiałów od tytanu, stali nierdzewnych i stopów wysokotemperaturowych do aluminium i innych metali nieżelaznych.

High Performance Drills

Foret Haute Performance Hochleistungsbohrer
Punte ad alte prestazioni Wiertła wysoko wydajne

	Page
Twister® Micro Tuff™ Drills	
Series 305 Uncoated	114 - 115
Series 305AM Coated	116
Twister®	
Series MPDCS	117
Twister® Micro XD Drills	
Series MXDSR	118
Twister®	
Series MXDCR	119
Twister® XD Spot Drill	
Series 200S	120
Cyclone CXD High Performance Drills 3xD	
Series CXDSS, CXDCS	120 - 123
Twister® XD High Performance Drills 3xD	
Series XDSSM, XDSCM	124 - 126
Cyclone CXD High Performance Drills 5xD	
Series CXDSR, CXDCR	127 - 129
Twister® XD High Performance Drills 5xD	
Series XD SRM & XD CRM	130 - 133
Twister® XD High Performance Drills 7+xD	
Series XDCLM	133 - 135
Cyclone CXD High Performance Drills 8xD	
Series CXDCLM	135 - 138
Cyclone CXD High Performance Drills 15xD	
Series CXDCEM	139
Twister® XD High Performance Micro Drill 10xD	
Series MDCLM	140
Twister® High Performance Micro Drill 12xD	
Series MXDCL	141
Twister® XD High Performance Drill 12+xD	
Series XDCEM	142
Cyclone CDA High Performance Aluminium Drill 5xD	
Series CDACRM	143 - 144
Technical Information	145 - 156

Twister® Micro-Tuff™ Drill Series 305 Uncoated

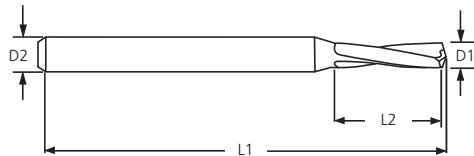

Series 305	Drill Dimensions			
Tool No	Ø D1	Ø D2	L1	L2
305 0010	0.1	3.0	38.0	1.7
305 0011	0.11	3.0	38.0	1.7
305 0012	0.12	3.0	38.0	1.7
305 0013	0.13	3.0	38.0	1.7
305 0014	0.14	3.0	38.0	1.7
305 0015	0.15	3.0	38.0	2.5
305 0016	0.16	3.0	38.0	2.5
305 0017	0.17	3.0	38.0	2.5
305 0018	0.18	3.0	38.0	2.5
305 0019	0.19	3.0	38.0	2.5
305 0020	0.2	3.0	38.0	2.5
305 0021	0.21	3.0	38.0	2.5
305 0022	0.22	3.0	38.0	2.5
305 0023	0.23	3.0	38.0	2.5
305 0024	0.24	3.0	38.0	2.5
305 0025	0.25	3.0	38.0	3.2
305 0026	0.26	3.0	38.0	3.2
305 0027	0.27	3.0	38.0	3.2
305 0028	0.28	3.0	38.0	3.2
305 0029	0.29	3.0	38.0	3.2
305 0030	0.3	3.0	38.0	4.8
305 0031	0.31	3.0	38.0	4.8
305 0032	0.32	3.0	38.0	4.8
305 0033	0.33	3.0	38.0	4.8
305 0034	0.34	3.0	38.0	4.8
305 0035	0.35	3.0	38.0	4.8
305 0036	0.36	3.0	38.0	4.8
305 0037	0.37	3.0	38.0	4.8
305 0038	0.38	3.0	38.0	4.8
305 0039	0.39	3.0	38.0	4.8
305 0040	0.4	3.0	38.0	4.8
305 0041	0.41	3.0	38.0	6.4
305 0042	0.42	3.0	38.0	6.4
305 0043	0.43	3.0	38.0	6.4
305 0044	0.44	3.0	38.0	6.4
305 0045	0.45	3.0	38.0	6.4
305 0046	0.46	3.0	38.0	6.4
305 0047	0.47	3.0	38.0	6.4
305 0048	0.48	3.0	38.0	6.4
305 0049	0.49	3.0	38.0	6.4
305 0050	0.5	3.0	38.0	6.4
305 0051	0.51	3.0	38.0	6.4
305 0052	0.52	3.0	38.0	6.4
305 0053	0.53	3.0	38.0	6.4
305 0054	0.54	3.0	38.0	6.4

Series 305	Drill Dimensions			
Tool No	Ø D1	Ø D2	L1	L2
305 0055	0.55	3.0	38.0	6.4
305 0056	0.56	3.0	38.0	6.4
305 0057	0.57	3.0	38.0	6.4
305 0058	0.58	3.0	38.0	6.4
305 0059	0.59	3.0	38.0	6.4
305 0060	0.6	3.0	38.0	6.4
305 0061	0.61	3.0	38.0	6.4
305 0062	0.62	3.0	38.0	6.4
305 0063	0.63	3.0	38.0	6.4
305 0064	0.64	3.0	38.0	6.4
305 0065	0.65	3.0	38.0	6.4
305 0066	0.66	3.0	38.0	8.1
305 0067	0.67	3.0	38.0	8.1
305 0068	0.68	3.0	38.0	8.1
305 0069	0.69	3.0	38.0	8.1
305 0070	0.7	3.0	38.0	8.1
305 0071	0.71	3.0	38.0	8.1
305 0072	0.72	3.0	38.0	8.1
305 0073	0.73	3.0	38.0	8.1
305 0074	0.74	3.0	38.0	8.1
305 0075	0.75	3.0	38.0	8.1
305 0076	0.76	3.0	38.0	10.2
305 0077	0.77	3.0	38.0	10.2
305 0078	0.78	3.0	38.0	10.2
305 0079	0.79	3.0	38.0	10.2
305 0080	0.8	3.0	38.0	10.2
305 0081	0.81	3.0	38.0	10.2
305 0082	0.82	3.0	38.0	10.2
305 0083	0.83	3.0	38.0	10.2
305 0084	0.84	3.0	38.0	10.2
305 0085	0.85	3.0	38.0	10.2
305 0086	0.86	3.0	38.0	10.2
305 0087	0.87	3.0	38.0	10.2
305 0088	0.88	3.0	38.0	10.2
305 0089	0.89	3.0	38.0	10.2
305 0090	0.9	3.0	38.0	10.2
305 0091	0.91	3.0	38.0	10.2
305 0092	0.92	3.0	38.0	10.2
305 0093	0.93	3.0	38.0	10.2
305 0094	0.94	3.0	38.0	10.2
305 0095	0.95	3.0	38.0	10.2
305 0096	0.96	3.0	38.0	10.2
305 0097	0.97	3.0	38.0	10.2
305 0098	0.98	3.0	38.0	10.2
305 0099	0.99	3.0	38.0	10.2

Twister® Micro-Tuff™ Drill Series 305 Uncoated

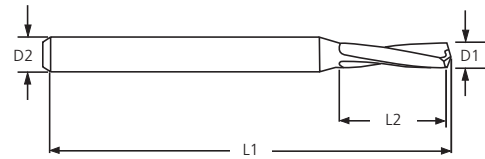
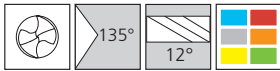

Series 305	Drill Dimensions			
Tool No	Ø D1	Ø D2	L1	L2
305 0100	1.0	3.0	38.0	10.2
305 0105	1.05	3.0	38.0	10.2
305 0110	1.1	3.0	38.0	10.2
305 0115	1.15	3.0	38.0	10.2
305 0120	1.2	3.0	38.0	10.2
305 0125	1.25	3.0	38.0	10.2
305 0130	1.3	3.0	38.0	10.2
305 0135	1.35	3.0	38.0	10.2
305 0140	1.4	3.0	38.0	10.2
305 0145	1.45	3.0	38.0	10.2
305 0150	1.5	3.0	38.0	10.2
305 0155	1.55	3.0	38.0	10.2
305 0160	1.6	3.0	38.0	12.2
305 0165	1.65	3.0	38.0	12.2
305 0170	1.7	3.0	38.0	12.2
305 0175	1.75	3.0	38.0	12.2
305 0180	1.8	3.0	38.0	12.2
305 0185	1.85	3.0	38.0	12.2
305 0190	1.9	3.0	38.0	12.2
305 0195	1.95	3.0	38.0	12.2
305 0200	2.0	3.0	38.0	12.2

Series 305	Drill Dimensions			
Tool No	Ø D1	Ø D2	L1	L2
305 0205	2.05	3.0	38.0	12.2
305 0210	2.1	3.0	38.0	12.2
305 0215	2.15	3.0	38.0	12.2
305 0220	2.2	3.0	38.0	12.2
305 0225	2.25	3.0	38.0	12.2
305 0230	2.3	3.0	38.0	12.2
305 0235	2.35	3.0	38.0	12.2
305 0240	2.4	3.0	38.0	12.2
305 0245	2.45	3.0	38.0	12.2
305 0250	2.5	3.0	38.0	12.2
305 0255	2.55	3.0	38.0	12.2
305 0260	2.6	3.0	38.0	12.2
305 0265	2.65	3.0	38.0	12.2
305 0270	2.7	3.0	38.0	12.2
305 0275	2.75	3.0	38.0	12.2
305 0280	2.8	3.0	38.0	12.2
305 0285	2.85	3.0	38.0	12.2
305 0290	2.9	3.0	38.0	12.2
305 0295	2.95	3.0	38.0	12.2
305 0300	3.0	3.0	38.0	12.2

Metric (mm)	
D1	Tolerance
0.10 - 3.00	+0/-0.008

Metric (mm)	
D2	Tolerance (h6)
3.00	+0/-0.005



Twister® Micro-Tuff™ Drill Series 305AM Coated

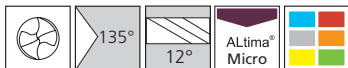

Series 305	Drill Dimensions			
Tool No	Ø D1	Ø D2	L1	L2
305 0030AM	0.3	3.0	38.0	4.8
305 0035AM	0.35	3.0	38.0	4.8
305 0040AM	0.4	3.0	38.0	4.8
305 0045AM	0.45	3.0	38.0	6.4
305 0050AM	0.5	3.0	38.0	6.4
305 0055AM	0.55	3.0	38.0	6.4
305 0060AM	0.6	3.0	38.0	6.4
305 0065AM	0.65	3.0	38.0	6.4
305 0070AM	0.7	3.0	38.0	8.1
305 0075AM	0.75	3.0	38.0	8.1
305 0080AM	0.8	3.0	38.0	10.2
305 0085AM	0.85	3.0	38.0	10.2
305 0090AM	0.9	3.0	38.0	10.2
305 0095AM	0.95	3.0	38.0	10.2
305 0100AM	1.0	3.0	38.0	10.2
305 0105AM	1.05	3.0	38.0	10.2
305 0110AM	1.1	3.0	38.0	10.2
305 0115AM	1.15	3.0	38.0	10.2
305 0120AM	1.2	3.0	38.0	10.2
305 0125AM	1.25	3.0	38.0	10.2
305 0130AM	1.3	3.0	38.0	10.2
305 0135AM	1.35	3.0	38.0	10.2
305 0140AM	1.4	3.0	38.0	10.2
305 0145AM	1.45	3.0	38.0	10.2
305 0150AM	1.5	3.0	38.0	10.2
305 0155AM	1.55	3.0	38.0	10.2
305 0160AM	1.6	3.0	38.0	12.2
305 0165AM	1.65	3.0	38.0	12.2

Series 305	Drill Dimensions			
Tool No	Ø D1	Ø D2	L1	L2
305 0170AM	1.7	3.0	38.0	12.2
305 0175AM	1.75	3.0	38.0	12.2
305 0180AM	1.8	3.0	38.0	12.2
305 0185AM	1.85	3.0	38.0	12.2
305 0190AM	1.9	3.0	38.0	12.2
305 0195AM	1.95	3.0	38.0	12.2
305 0200AM	2.0	3.0	38.0	12.2
305 0205AM	2.05	3.0	38.0	12.2
305 0210AM	2.1	3.0	38.0	12.2
305 0215AM	2.15	3.0	38.0	12.2
305 0220AM	2.2	3.0	38.0	12.2
305 0225AM	2.25	3.0	38.0	12.2
305 0230AM	2.3	3.0	38.0	12.2
305 0235AM	2.35	3.0	38.0	12.2
305 0240AM	2.4	3.0	38.0	12.2
305 0245AM	2.45	3.0	38.0	12.2
305 0250AM	2.5	3.0	38.0	12.2
305 0255AM	2.55	3.0	38.0	12.2
305 0260AM	2.6	3.0	38.0	12.2
305 0265AM	2.65	3.0	38.0	12.2
305 0270AM	2.7	3.0	38.0	12.2
305 0275AM	2.75	3.0	38.0	12.2
305 0280AM	2.8	3.0	38.0	12.2
305 0285AM	2.85	3.0	38.0	12.2
305 0290AM	2.9	3.0	38.0	12.2
305 0295AM	2.95	3.0	38.0	12.2
305 0300AM	3.0	3.0	38.0	12.2



Metric (mm)	
D1	Tolerance
0.10 - 3.00	+0/-0.008

Metric (mm)	
D2	Tolerance (h6)
3.00	+0/-0.005

Twister® Micro XD Series MPDCS

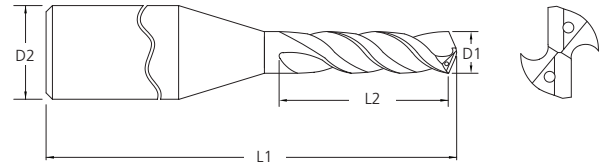
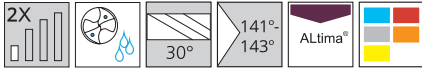

Series MPDCS		Drill Dimensions			
Tool No.	EDP	Ø D1	Ø D2	L1	L2
MPDCSM0100A	04874	1.0	3.0	45.0	4.0
MPDCSM0105A	04875	1.0	3.0	45.0	4.0
MPDCSM0110A	04876	1.1	3.0	45.0	4.0
MPDCSM0115A	04877	1.15	3.0	45.0	5.0
MPDCSM0120A	04878	1.2	3.0	45.0	5.0
MPDCSM0125A	04879	1.25	3.0	45.0	5.0
MPDCSM0130A	04880	1.3	3.0	45.0	5.0
MPDCSM0135A	04881	1.35	3.0	45.0	5.0
MPDCSM0140A	04882	1.4	3.0	45.0	6.0
MPDCSM0145A	04883	1.45	3.0	45.0	6.0
MPDCSM0150A	04884	1.5	3.0	45.0	6.0
MPDCSM0155A	04885	1.55	3.0	45.0	6.0
MPDCSM0160A	04886	1.6	3.0	45.0	6.0
MPDCSM0165A	04887	1.65	3.0	50.0	7.0
MPDCSM0170A	04888	1.7	3.0	50.0	7.0
MPDCSM0175A	04889	1.75	3.0	50.0	7.0
MPDCSM0180A	04890	1.8	3.0	50.0	7.0
MPDCSM0185A	04891	1.85	3.0	50.0	7.0
MPDCSM0190A	04892	1.9	3.0	50.0	8.0
MPDCSM0195A	04893	1.95	3.0	50.0	8.0

Series MPDCS		Drill Dimensions			
Tool No.	EDP	Ø D1	Ø D2	L1	L2
MPDCSM0200A	04894	2.0	3.0	50.0	8.0
MPDCSM0205A	04895	2.05	3.0	60.0	8.0
MPDCSM0210A	04896	2.1	3.0	60.0	8.0
MPDCSM0215A	04897	2.15	3.0	60.0	9.0
MPDCSM0220A	04898	2.2	3.0	60.0	9.0
MPDCSM0225A	04899	2.25	3.0	60.0	9.0
MPDCSM0230A	04900	2.3	3.0	60.0	9.0
MPDCSM0235A	04901	2.35	3.0	60.0	9.0
MPDCSM0240A	04902	2.4	3.0	60.0	10.0
MPDCSM0245A	04903	2.45	3.0	60.0	10.0
MPDCSM0250A	04904	2.5	3.0	60.0	10.0
MPDCSM0255A	04905	2.55	3.0	60.0	10.0
MPDCSM0260A	04906	2.6	3.0	60.0	10.0
MPDCSM0265A	04907	2.65	3.0	60.0	11.0
MPDCSM0270A	04908	2.7	3.0	60.0	11.0
MPDCSM0275A	04909	2.75	3.0	60.0	11.0
MPDCSM0280A	04910	2.8	3.0	60.0	11.0
MPDCSM0285A	04911	2.85	3.0	60.0	11.0
MPDCSM0290A	04912	2.9	3.0	60.0	12.0
MPDCSM0295A	04913	2.95	3.0	60.0	12.0

Metric (mm)	
D1	Tolerance
1.00 - 2.95	+0.004/+0.014

Metric (mm)	
D2	Tolerance (h6)
3.00	+0/-0.006



Twister® Micro XD Series MXDSR

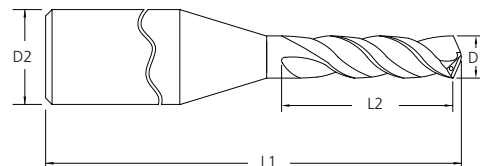
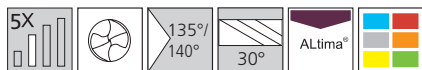

ALtima®		Drill Dimensions			
Tool No	EDP	Ø D1	Ø D2	L1	L2
MXDSRM0050A	04694	0.5	3.0	57.0	4.0
MXDSRM0055A	04696	0.55	3.0	57.0	4.0
MXDSRM0060A	04698	0.6	3.0	57.0	5.0
MXDSRM0065A	04700	0.65	3.0	57.0	5.0
MXDSRM0070A	04702	0.7	3.0	57.0	5.0
MXDSRM0075A	04704	0.75	3.0	57.0	6.0
MXDSRM0080A	04706	0.8	3.0	57.0	6.0
MXDSRM0085A	04708	0.85	3.0	57.0	7.0
MXDSRM0090A	04710	0.9	3.0	57.0	7.0
MXDSRM0095A	04712	0.95	3.0	57.0	7.0
MXDSRM0100A	04714	1.0	3.0	57.0	8.0
MXDSRM0105A	04716	1.05	3.0	57.0	8.0
MXDSRM0110A	04718	1.1	3.0	57.0	8.0
MXDSRM0115A	04720	1.15	3.0	57.0	9.0
MXDSRM0120A	04722	1.2	3.0	57.0	9.0
MXDSRM0125A	04724	1.25	3.0	57.0	9.0
MXDSRM0130A	04726	1.3	3.0	57.0	10.0
MXDSRM0135A	04728	1.35	3.0	57.0	10.0
MXDSRM0140A	04730	1.4	3.0	57.0	10.0
MXDSRM0145A	04732	1.45	3.0	57.0	11.0
MXDSRM0150A	04734	1.5	3.0	57.0	11.0
MXDSRM0155A	04736	1.55	3.0	57.0	12.0
MXDSRM0160A	04738	1.6	3.0	57.0	12.0
MXDSRM0165A	04740	1.65	3.0	57.0	12.0
MXDSRM0170A	04742	1.7	3.0	57.0	13.0

ALtima®		Drill Dimensions			
Tool No	EDP	Ø D1	Ø D2	L1	L2
MXDSRM0175A	04744	1.75	3.0	57.0	13.0
MXDSRM0180A	04746	1.8	3.0	57.0	13.0
MXDSRM0185A	04748	1.85	3.0	57.0	14.0
MXDSRM0190A	04750	1.9	3.0	57.0	14.0
MXDSRM0195A	04752	1.95	3.0	57.0	14.0
MXDSRM0200A	04754	2.0	3.0	57.0	15.0
MXDSRM0205A	04756	2.05	3.0	57.0	15.0
MXDSRM0210A	04758	2.1	3.0	57.0	15.0
MXDSRM0215A	04760	2.15	3.0	57.0	16.0
MXDSRM0220A	04762	2.2	3.0	57.0	16.0
MXDSRM0225A	04764	2.25	3.0	57.0	17.0
MXDSRM0230A	04766	2.3	3.0	57.0	17.0
MXDSRM0235A	04768	2.35	3.0	57.0	17.0
MXDSRM0240A	04770	2.4	3.0	57.0	18.0
MXDSRM0245A	04772	2.45	3.0	57.0	18.0
MXDSRM0250A	04774	2.5	3.0	57.0	18.0
MXDSRM0255A	04776	2.55	3.0	57.0	19.0
MXDSRM0260A	04778	2.6	3.0	57.0	19.0
MXDSRM0265A	04780	2.65	3.0	57.0	19.0
MXDSRM0270A	04782	2.7	3.0	57.0	20.0
MXDSRM0275A	04784	2.75	3.0	57.0	20.0
MXDSRM0280A	04786	2.8	3.0	57.0	20.0
MXDSRM0285A	04788	2.85	3.0	57.0	21.0
MXDSRM0290A	04790	2.9	3.0	57.0	21.0
MXDSRM0295A	04792	2.95	3.0	57.0	22.0

Metric (mm)	
D1	Tolerance (h7)
0.5 - 2.95	+0/-0.010

Metric (mm)	
D2	Tolerance (h6)
3.0	+0/-0.006



Twister® Micro XD Series MXDCR

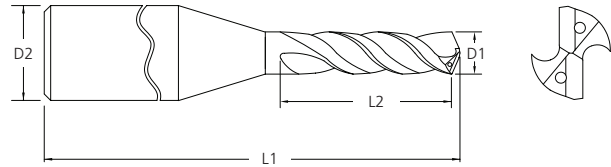
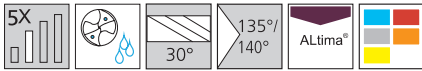

ALtima®		Drill Dimensions			
Tool No.	EDP	Ø D1	Ø D2	L1	L2
MXDCRM0100A	04794	1.0	3.0	57.0	8.0
MXDCRM0105A	04795	1.05	3.0	57.0	8.0
MXDCRM0110A	04796	1.1	3.0	57.0	8.0
MXDCRM0115A	04797	1.15	3.0	57.0	9.0
MXDCRM0120A	04798	1.2	3.0	57.0	9.0
MXDCRM0125A	04799	1.25	3.0	57.0	9.0
MXDCRM0130A	04800	1.3	3.0	57.0	10.0
MXDCRM0135A	04801	1.35	3.0	57.0	10.0
MXDCRM0140A	04802	1.4	3.0	57.0	10.0
MXDCRM0145A	04803	1.45	3.0	57.0	11.0
MXDCRM0150A	04804	1.5	3.0	57.0	11.0
MXDCRM0155A	04805	1.55	3.0	57.0	12.0
MXDCRM0160A	04806	1.6	3.0	57.0	12.0
MXDCRM0165A	04807	1.65	3.0	57.0	12.0
MXDCRM0170A	04808	1.7	3.0	57.0	13.0
MXDCRM0175A	04809	1.75	3.0	57.0	13.0
MXDCRM0180A	04810	1.8	3.0	57.0	13.0
MXDCRM0185A	04811	1.85	3.0	57.0	14.0
MXDCRM0190A	04812	1.9	3.0	57.0	14.0
MXDCRM0195A	04813	1.95	3.0	57.0	14.0

ALtima®		Drill Dimensions			
Tool No.	EDP	Ø D1	Ø D2	L1	L2
MXDCRM0200A	04814	2.0	3.0	57.0	15.0
MXDCRM0205A	04815	2.05	3.0	60.0	15.0
MXDCRM0210A	04816	2.1	3.0	60.0	15.0
MXDCRM0215A	04817	2.15	3.0	60.0	16.0
MXDCRM0220A	04818	2.2	3.0	60.0	16.0
MXDCRM0225A	04819	2.25	3.0	60.0	17.0
MXDCRM0230A	04820	2.3	3.0	60.0	17.0
MXDCRM0235A	04821	2.35	3.0	60.0	17.0
MXDCRM0240A	04822	2.4	3.0	60.0	18.0
MXDCRM0245A	04823	2.45	3.0	60.0	18.0
MXDCRM0250A	04824	2.5	3.0	60.0	18.0
MXDCRM0255A	04825	2.55	3.0	60.0	19.0
MXDCRM0260A	04826	2.6	3.0	60.0	19.0
MXDCRM0265A	04827	2.65	3.0	60.0	19.0
MXDCRM0270A	04828	2.7	3.0	60.0	20.0
MXDCRM0275A	04829	2.75	3.0	60.0	20.0
MXDCRM0280A	04830	2.8	3.0	60.0	20.0
MXDCRM0285A	04831	2.85	3.0	60.0	21.0
MXDCRM0290A	04832	2.9	3.0	60.0	21.0
MXDCRM0295A	04833	2.95	3.0	60.0	22.0

Metric (mm)	
D1	Tolerance (h7)
1.00 - 2.95	+0/-0.010

Metric (mm)	
D2	Tolerance (h6)
3.00	+0/-0.006



Twister® XD Spot Drill Series 200S

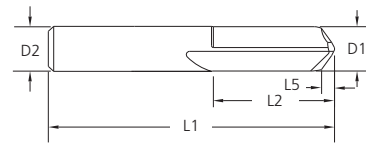
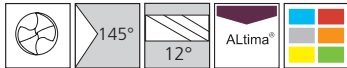

Series 200S	Drill Dimensions				
Tool No.	Ø D1	Ø D2	L1	L2	L5
200S 0300A	3.0	3.0	38.0	16.0	0.4
200S 0600A	6.0	6.0	51.0	19.0	0.8
200S 0800A	8.0	8.0	64.0	19.0	1.1
200S 1000A	10.0	10.0	70.0	25.0	1.4
200S 1200A	12.0	12.0	76.0	25.0	1.7
200S 1600A	16.0	16.0	89.0	32.0	2.2



CYCLONE CXD High Performance Drill - 3xD Series CXDSS & CXDCS

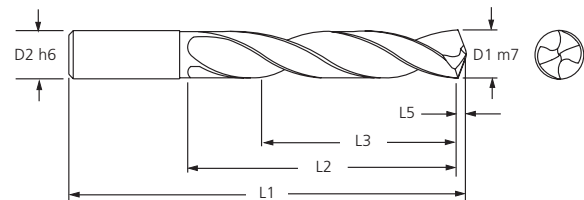
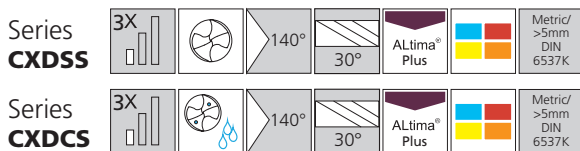

Tool No.		Drill Dimensions (mm)					
CXDSS	CXDCS	Ø D1	Ø D2	L1	L2 (Max.)	L3	L5
CXDSS 0300AP	CXDCS 0300AP	3.0	3.0	62.0	20.0	14.0	0.46
CXDSS 0310AP	CXDCS 0310AP	3.1	4.0	62.0	20.0	14.0	0.48
CXDSS 0320AP	CXDCS 0320AP	3.2	4.0	62.0	20.0	14.0	0.5
CXDSS 0330AP	CXDCS 0330AP	3.3	4.0	62.0	20.0	14.0	0.51
CXDSS 0340AP	CXDCS 0340AP	3.4	4.0	62.0	20.0	14.0	0.53
CXDSS 0350AP	CXDCS 0350AP	3.5	4.0	62.0	20.0	14.0	0.54
CXDSS 0360AP	CXDCS 0360AP	3.6	4.0	62.0	20.0	14.0	0.56
CXDSS 0370AP	CXDCS 0370AP	3.7	4.0	62.0	20.0	14.0	0.57
CXDSS 0380AP	CXDCS 0380AP	3.8	4.0	66.0	24.0	17.0	0.59
CXDSS 0390AP	CXDCS 0390AP	3.9	4.0	66.0	24.0	17.0	0.6
CXDSS 0400AP	CXDCS 0400AP	4.0	4.0	66.0	24.0	17.0	0.62
CXDSS 0410AP	CXDCS 0410AP	4.1	5.0	66.0	24.0	17.0	0.64
CXDSS 0420AP	CXDCS 0420AP	4.2	5.0	66.0	24.0	17.0	0.65
CXDSS 0430AP	CXDCS 0430AP	4.3	5.0	66.0	24.0	17.0	0.67
CXDSS 0440AP	CXDCS 0440AP	4.4	5.0	66.0	24.0	17.0	0.68
CXDSS 0450AP	CXDCS 0450AP	4.5	5.0	66.0	24.0	17.0	0.7
CXDSS 0460AP	CXDCS 0460AP	4.6	5.0	66.0	24.0	17.0	0.71
CXDSS 0470AP	CXDCS 0470AP	4.7	5.0	66.0	24.0	17.0	0.73

CYCLONE CXD High Performance Drill - 3xD Series CXDSS & CXDCS

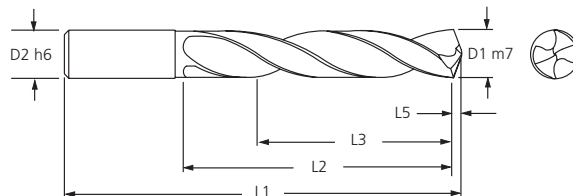
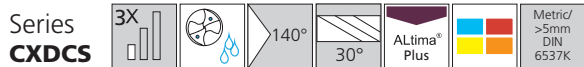
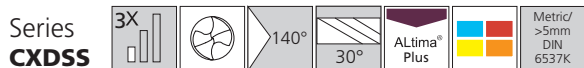

Tool No.		Drill Dimensions (mm)					
CXDSS	CXDCS	Ø D1	Ø D2	L1	L2 (Max.)	L3	L5
CXDSS 0480AP	CXDCS 0480AP	4.8	5.0	66.0	28.0	20.0	0.74
CXDSS 0490AP	CXDCS 0490AP	4.9	5.0	66.0	28.0	20.0	0.76
CXDSS 0500AP	CXDCS 0500AP	5.0	5.0	66.0	28.0	20.0	0.77
CXDSS 0510AP	CXDCS 0510AP	5.1	6.0	66.0	28.0	20.0	0.79
CXDSS 0520AP	CXDCS 0520AP	5.2	6.0	66.0	28.0	20.0	0.81
CXDSS 0530AP	CXDCS 0530AP	5.3	6.0	66.0	28.0	20.0	0.82
CXDSS 0540AP	CXDCS 0540AP	5.4	6.0	66.0	28.0	20.0	0.84
CXDSS 0550AP	CXDCS 0550AP	5.5	6.0	66.0	28.0	20.0	0.85
CXDSS 0560AP	CXDCS 0560AP	5.6	6.0	66.0	28.0	20.0	0.86
CXDSS 0570AP	CXDCS 0570AP	5.7	6.0	66.0	28.0	20.0	0.88
CXDSS 0580AP	CXDCS 0580AP	5.8	6.0	66.0	28.0	20.0	0.9
CXDSS 0590AP	CXDCS 0590AP	5.9	6.0	66.0	28.0	20.0	0.91
CXDSS 0600AP	CXDCS 0600AP	6.0	6.0	66.0	28.0	20.0	0.93
CXDSS 0610AP	CXDCS 0610AP	6.1	8.0	79.0	34.0	24.0	0.95
CXDSS 0620AP	CXDCS 0620AP	6.2	8.0	79.0	34.0	24.0	0.96
CXDSS 0630AP	CXDCS 0630AP	6.3	8.0	79.0	34.0	24.0	0.98
CXDSS 0640AP	CXDCS 0640AP	6.4	8.0	79.0	34.0	24.0	0.99
CXDSS 0650AP	CXDCS 0650AP	6.5	8.0	79.0	34.0	24.0	1.01
CXDSS 0660AP	CXDCS 0660AP	6.6	8.0	79.0	34.0	24.0	1.03
CXDSS 0670AP	CXDCS 0670AP	6.7	8.0	79.0	34.0	24.0	1.04
CXDSS 0680AP	CXDCS 0680AP	6.8	8.0	79.0	34.0	24.0	1.05
CXDSS 0690AP	CXDCS 0690AP	6.9	8.0	79.0	34.0	24.0	1.07
CXDSS 0700AP	CXDCS 0700AP	7.0	8.0	79.0	34.0	24.0	1.08
CXDSS 0710AP	CXDCS 0710AP	7.1	8.0	79.0	41.0	29.0	1.1
CXDSS 0720AP	CXDCS 0720AP	7.2	8.0	79.0	41.0	29.0	1.12
CXDSS 0730AP	CXDCS 0730AP	7.3	8.0	79.0	41.0	29.0	1.13
CXDSS 0740AP	CXDCS 0740AP	7.4	8.0	79.0	41.0	29.0	1.15
CXDSS 0750AP	CXDCS 0750AP	7.5	8.0	79.0	41.0	29.0	1.16
CXDSS 0760AP	CXDCS 0760AP	7.6	8.0	79.0	41.0	29.0	1.18
CXDSS 0770AP	CXDCS 0770AP	7.7	8.0	79.0	41.0	29.0	1.19
CXDSS 0780AP	CXDCS 0780AP	7.8	8.0	79.0	41.0	29.0	1.21
CXDSS 0790AP	CXDCS 0790AP	7.9	8.0	79.0	41.0	29.0	1.22
CXDSS 0800AP	CXDCS 0800AP	8.0	8.0	79.0	41.0	29.0	1.24
CXDSS 0810AP	CXDCS 0810AP	8.1	10.0	89.0	47.0	35.0	1.26
CXDSS 0820AP	CXDCS 0820AP	8.2	10.0	89.0	47.0	35.0	1.27
CXDSS 0830AP	CXDCS 0830AP	8.3	10.0	89.0	47.0	35.0	1.29
CXDSS 0840AP	CXDCS 0840AP	8.4	10.0	89.0	47.0	35.0	1.31
CXDSS 0850AP	CXDCS 0850AP	8.5	10.0	89.0	47.0	35.0	1.32
CXDSS 0860AP	CXDCS 0860AP	8.6	10.0	89.0	47.0	35.0	1.33
CXDSS 0870AP	CXDCS 0870AP	8.7	10.0	89.0	47.0	35.0	1.35
CXDSS 0880AP	CXDCS 0880AP	8.8	10.0	89.0	47.0	35.0	1.36



CYCLONE CXD High Performance Drill - 3xD Series CXDSS & CXDCS

Series **CXDSS**

Series **CXDCS**

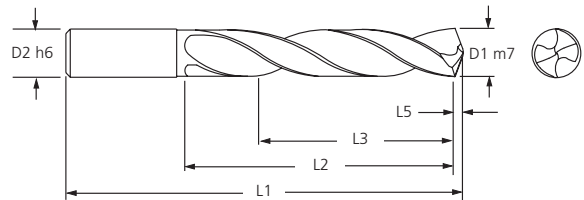

Tool No.		Drill Dimensions (mm)					
CXDSS	CXDCS	Ø D1	Ø D2	L1	L2 (Max.)	L3	L5
CXDSS 0890AP	CXDCS 0890AP	8.9	10.0	89.0	47.0	35.0	1.38
CXDSS 0900AP	CXDCS 0900AP	9.0	10.0	89.0	47.0	35.0	1.39
CXDSS 0910AP	CXDCS 0910AP	9.1	10.0	89.0	47.0	35.0	1.41
CXDSS 0920AP	CXDCS 0920AP	9.2	10.0	89.0	47.0	35.0	1.43
CXDSS 0925AP	CXDCS 0925AP	9.25	10.0	89.0	47.0	35.0	1.43
CXDSS 0930AP	CXDCS 0930AP	9.3	10.0	89.0	47.0	35.0	1.44
CXDSS 0940AP	CXDCS 0940AP	9.4	10.0	89.0	47.0	35.0	1.46
CXDSS 0950AP	CXDCS 0950AP	9.5	10.0	89.0	47.0	35.0	1.47
CXDSS 0960AP	CXDCS 0960AP	9.6	10.0	89.0	47.0	35.0	1.49
CXDSS 0970AP	CXDCS 0970AP	9.7	10.0	89.0	47.0	35.0	1.5
CXDSS 0980AP	CXDCS 0980AP	9.8	10.0	89.0	47.0	35.0	1.52
CXDSS 0990AP	CXDCS 0990AP	9.9	10.0	89.0	47.0	35.0	1.53
CXDSS 1000AP	CXDCS 1000AP	10.0	10.0	89.0	47.0	35.0	1.55
CXDSS 1010AP	CXDCS 1010AP	10.1	12.0	102.0	55.0	40.0	1.56
CXDSS 1020AP	CXDCS 1020AP	10.2	12.0	102.0	55.0	40.0	1.58
CXDSS 1030AP	CXDCS 1030AP	10.3	12.0	102.0	55.0	40.0	1.6
CXDSS 1040AP	CXDCS 1040AP	10.4	12.0	102.0	55.0	40.0	1.61
CXDSS 1050AP	CXDCS 1050AP	10.5	12.0	102.0	55.0	40.0	1.63
CXDSS 1060AP	CXDCS 1060AP	10.6	12.0	102.0	55.0	40.0	1.64
CXDSS 1070AP	CXDCS 1070AP	10.7	12.0	102.0	55.0	40.0	1.66
CXDSS 1080AP	CXDCS 1080AP	10.8	12.0	102.0	55.0	40.0	1.67
CXDSS 1090AP	CXDCS 1090AP	10.9	12.0	102.0	55.0	40.0	1.69
CXDSS 1100AP	CXDCS 1100AP	11.0	12.0	102.0	55.0	40.0	1.7
CXDSS 1110AP	CXDCS 1110AP	11.1	12.0	102.0	55.0	40.0	1.72
CXDSS 1120AP	CXDCS 1120AP	11.2	12.0	102.0	55.0	40.0	1.74
CXDSS 1130AP	CXDCS 1130AP	11.3	12.0	102.0	55.0	40.0	1.75
CXDSS 1140AP	CXDCS 1140AP	11.4	12.0	102.0	55.0	40.0	1.77
CXDSS 1150AP	CXDCS 1150AP	11.5	12.0	102.0	55.0	40.0	1.78
CXDSS 1160AP	CXDCS 1160AP	11.6	12.0	102.0	55.0	40.0	1.8
CXDSS 1170AP	CXDCS 1170AP	11.7	12.0	102.0	55.0	40.0	1.81

CYCLONE CXD High Performance Drill - 3xD Series CXDSS & CXDCS

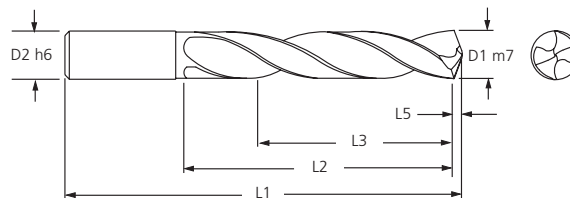
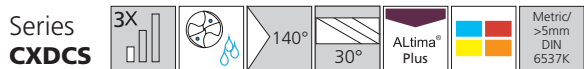
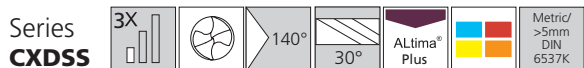

Tool No.		Drill Dimensions (mm)					
CXDSS	CXDCS	Ø D1	Ø D2	L1	L2 (Max.)	L3	L5
CXDSS 1180AP	CXDCS 1180AP	11.8	12.0	102.0	55.0	40.0	1.83
CXDSS 1190AP	CXDCS 1190AP	11.9	12.0	102.0	55.0	40.0	1.84
CXDSS 1200AP	CXDCS 1200AP	12.0	12.0	102.0	55.0	40.0	1.86
CXDSS 1210AP	CXDCS 1210AP	12.1	14.0	107.0	60.0	43.0	1.87
CXDSS 1250AP	CXDCS 1250AP	12.5	14.0	107.0	60.0	43.0	1.94
CXDSS 1280AP	CXDCS 1280AP	12.8	14.0	107.0	60.0	43.0	1.98
CXDSS 1283AP	CXDCS 1283AP	12.83	14.0	107.0	60.0	43.0	1.99
CXDSS 1290AP	CXDCS 1290AP	12.9	14.0	107.0	60.0	43.0	2.0
CXDSS 1300AP	CXDCS 1300AP	13.0	14.0	107.0	60.0	43.0	2.01
CXDSS 1350AP	CXDCS 1350AP	13.5	14.0	107.0	60.0	43.0	2.09
CXDSS 1370AP	CXDCS 1370AP	13.7	14.0	107.0	60.0	43.0	2.12
CXDSS 1400AP	CXDCS 1400AP	14.0	14.0	107.0	60.0	43.0	2.17
CXDSS 1450AP	CXDCS 1450AP	14.5	16.0	115.0	65.0	45.0	2.25
CXDSS 1470AP	CXDCS 1470AP	14.7	16.0	115.0	65.0	45.0	2.28
CXDSS 1500AP	CXDCS 1500AP	15.0	16.0	115.0	65.0	45.0	2.32
CXDSS 1530AP	CXDCS 1530AP	15.3	16.0	115.0	65.0	45.0	2.37
CXDSS 1550AP	CXDCS 1550AP	15.5	16.0	115.0	65.0	45.0	2.4
CXDSS 1570AP	CXDCS 1570AP	15.7	16.0	115.0	65.0	45.0	2.43
CXDSS 1600AP	CXDCS 1600AP	16.0	16.0	115.0	65.0	45.0	2.48
CXDSS 1608AP	-	16.08	18.0	123.0	73.0	51.0	2.49
CXDSS 1630AP	-	16.3	18.0	123.0	73.0	51.0	2.53
CXDSS 1650AP	-	16.5	18.0	123.0	73.0	51.0	2.56
CXDSS 1700AP	-	17.0	18.0	123.0	73.0	51.0	2.63
CXDSS 1750AP	-	17.5	18.0	123.0	73.0	51.0	2.71
CXDSS 1800AP	-	18.0	18.0	123.0	73.0	51.0	2.79
CXDSS 1850AP	-	18.5	20.0	131.0	79.0	55.0	2.87
CXDSS 1916AP	-	19.16	20.0	131.0	79.0	55.0	2.97
CXDSS 1925AP	-	19.25	20.0	131.0	79.0	55.0	2.98
CXDSS 1930AP	-	19.3	20.0	131.0	79.0	55.0	2.99
CXDSS 1950AP	-	19.5	20.0	131.0	79.0	55.0	3.02
CXDSS 2000AP	-	20.0	20.0	131.0	79.0	55.0	3.1

D1	Tolerance (m7)	D2	Tolerance (h6)
0 - 3.0	+0.002/+0.012	0 - 3.0	+0/-0.006
3.01 - 6.0	+0.004/+0.016	3.01 - 6.0	+0/-0.008
6.01 - 10.0	+0.006/+0.021	6.01 - 10.0	+0/-0.009
10.01 - 18.0	+0.007/+0.025	10.01 - 18.0	+0/-0.011
18.01 - 20.0	+0.008/+0.029	18.01 - 20.0	+0/-0.013



Twister® XD High Performance Drill - 3xD Series XDSSM & XDSCSM

Series XD SSM

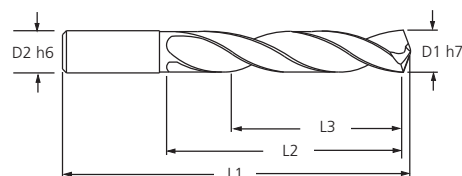
Series XD CSM

Series 2XDSSM	Drill Dimensions XD SSM					Series 2XDSCSM	Drill Dimensions XD CSM				
Tool No.	Ø D1	Ø D2	L1	L2	L3	Tool No.	Ø D1	Ø D2	L1	L2	L3
2XDSSM0250A	2.5	2.5	43.0	14.0	11.0	-	-	-	-	-	-
2XDSSM0290A	2.9	2.9	46.0	16.0	12.0	-	-	-	-	-	-
2XDSSM0300A	3.0	3.0	57.0	16.0	13.0	2XDSCSM0300A	3.0	3.0	57.0	16.0	13.0
2XDSSM0310A	3.1	4.0	63.0	22.0	18.0	2XDSCSM0310A	3.1	4.0	63.0	22.0	18.0
2XDSSM0320A	3.2	4.0	63.0	22.0	18.0	2XDSCSM0320A	3.2	4.0	63.0	22.0	18.0
2XDSSM0330A	3.3	4.0	63.0	22.0	18.0	2XDSCSM0330A	3.3	4.0	63.0	22.0	18.0
2XDSSM0340A	3.4	4.0	63.0	22.0	18.0	2XDSCSM0340A	3.4	4.0	63.0	22.0	18.0
2XDSSM0350A	3.5	4.0	63.0	22.0	18.0	2XDSCSM0350A	3.5	4.0	63.0	22.0	18.0
2XDSSM0360A	3.6	4.0	63.0	22.0	18.0	2XDSCSM0360A	3.6	4.0	63.0	22.0	18.0
2XDSSM0370A	3.7	4.0	63.0	22.0	18.0	2XDSCSM0370A	3.7	4.0	63.0	22.0	18.0
2XDSSM0380A	3.8	4.0	63.0	22.0	18.0	2XDSCSM0380A	3.8	4.0	63.0	22.0	18.0
2XDSSM0390A	3.9	4.0	63.0	22.0	18.0	2XDSCSM0390A	3.9	4.0	63.0	22.0	18.0
2XDSSM0400A	4.0	4.0	63.0	22.0	18.0	2XDSCSM0400A	4.0	4.0	63.0	22.0	18.0
2XDSSM0410A	4.1	5.0	63.0	26.0	21.0	2XDSCSM0410A	4.1	5.0	63.0	26.0	21.0
2XDSSM0420A	4.2	5.0	63.0	26.0	21.0	2XDSCSM0420A	4.2	5.0	63.0	26.0	21.0
2XDSSM0430A	4.3	5.0	63.0	26.0	21.0	2XDSCSM0430A	4.3	5.0	63.0	26.0	21.0
2XDSSM0440A	4.4	5.0	63.0	26.0	21.0	2XDSCSM0440A	4.4	5.0	63.0	26.0	21.0
2XDSSM0450A	4.5	5.0	63.0	26.0	21.0	2XDSCSM0450A	4.5	5.0	63.0	26.0	21.0
2XDSSM0460A	4.6	5.0	63.0	26.0	21.0	2XDSCSM0460A	4.6	5.0	63.0	26.0	21.0
2XDSSM0470A	4.7	5.0	63.0	26.0	21.0	2XDSCSM0470A	4.7	5.0	63.0	26.0	21.0
2XDSSM0480A	4.8	5.0	63.0	26.0	21.0	2XDSCSM0480A	4.8	5.0	63.0	26.0	21.0
2XDSSM0490A	4.9	5.0	63.0	26.0	21.0	2XDSCSM0490A	4.9	5.0	63.0	26.0	21.0
2XDSSM0500A	5.0	5.0	63.0	26.0	21.0	2XDSCSM0500A	5.0	5.0	63.0	26.0	21.0
2XDSSM0510A	5.1	6.0	76.0	30.0	24.0	2XDSCSM0510A	5.1	6.0	66.0	28.0	20.0
2XDSSM0520A	5.2	6.0	76.0	30.0	24.0	2XDSCSM0520A	5.2	6.0	66.0	28.0	20.0
2XDSSM0530A	5.3	6.0	76.0	30.0	24.0	2XDSCSM0530A	5.3	6.0	66.0	28.0	20.0
2XDSSM0540A	5.4	6.0	76.0	30.0	24.0	2XDSCSM0540A	5.4	6.0	66.0	28.0	20.0
2XDSSM0550A	5.5	6.0	76.0	30.0	24.0	2XDSCSM0550A	5.5	6.0	66.0	28.0	20.0
2XDSSM0570A	5.7	6.0	76.0	30.0	24.0	2XDSCSM0570A	5.7	6.0	66.0	28.0	20.0
2XDSSM0580A	5.8	6.0	76.0	30.0	24.0	2XDSCSM0580A	5.8	6.0	66.0	28.0	20.0
2XDSSM0590A	5.9	6.0	76.0	30.0	24.0	2XDSCSM0590A	5.9	6.0	66.0	28.0	20.0
2XDSSM0600A	6.0	6.0	76.0	30.0	24.0	2XDSCSM0600A	6.0	6.0	66.0	28.0	20.0
2XDSSM0610A	6.1	8.0	82.0	35.0	28.0	2XDSCSM0610A	6.1	8.0	79.0	34.0	24.0
2XDSSM0620A	6.2	8.0	82.0	35.0	28.0	2XDSCSM0620A	6.2	8.0	79.0	34.0	24.0
2XDSSM0630A	6.3	8.0	82.0	35.0	28.0	2XDSCSM0630A	6.3	8.0	79.0	34.0	24.0
2XDSSM0640A	6.4	8.0	82.0	35.0	28.0	2XDSCSM0640A	6.4	8.0	79.0	34.0	24.0
2XDSSM0650A	6.5	8.0	82.0	35.0	28.0	2XDSCSM0650A	6.5	8.0	79.0	34.0	24.0
2XDSSM0660A	6.6	8.0	82.0	35.0	28.0	2XDSCSM0660A	6.6	8.0	79.0	34.0	24.0
2XDSSM0670A	6.7	8.0	82.0	35.0	28.0	2XDSCSM0670A	6.7	8.0	79.0	34.0	24.0
2XDSSM0680A	6.8	8.0	82.0	35.0	28.0	2XDSCSM0680A	6.8	8.0	79.0	34.0	24.0
2XDSSM0690A	6.9	8.0	82.0	35.0	28.0	2XDSCSM0690A	6.9	8.0	79.0	34.0	24.0
2XDSSM0700A	7.0	8.0	82.0	35.0	28.0	2XDSCSM0700A	7.0	8.0	79.0	34.0	24.0

Twister® XD High Performance Drill - 3xD Series XDSSM & XDSCSM

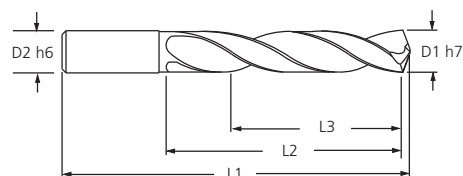
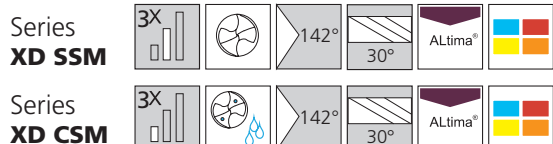

Series 2XDSSM	Drill Dimensions XD SSM					Series 2XDSCSM	Drill Dimensions XD CSM				
Tool No.	Ø D1	Ø D2	L1	L2	L3	Tool No.	Ø D1	Ø D2	L1	L2	L3
2XDSSM0710A	7.1	8.0	82.0	38.0	31.0	2XDSCSM0710A	7.1	8.0	79.0	41.0	29.0
2XDSSM0720A	7.2	8.0	82.0	38.0	31.0	2XDSCSM0720A	7.2	8.0	79.0	41.0	29.0
2XDSSM0730A	7.3	8.0	82.0	38.0	31.0	2XDSCSM0730A	7.3	8.0	79.0	41.0	29.0
2XDSSM0740A	7.4	8.0	82.0	38.0	31.0	2XDSCSM0740A	7.4	8.0	79.0	41.0	29.0
2XDSSM0750A	7.5	8.0	82.0	38.0	31.0	2XDSCSM0750A	7.5	8.0	79.0	41.0	29.0
2XDSSM0760A	7.6	8.0	82.0	38.0	31.0	2XDSCSM0760A	7.6	8.0	79.0	41.0	29.0
2XDSSM0770A	7.7	8.0	82.0	38.0	31.0	2XDSCSM0770A	7.7	8.0	79.0	41.0	29.0
2XDSSM0780A	7.8	8.0	82.0	38.0	31.0	2XDSCSM0780A	7.8	8.0	79.0	41.0	29.0
2XDSSM0790A	7.9	8.0	82.0	38.0	31.0	2XDSCSM0790A	7.9	8.0	79.0	41.0	29.0
2XDSSM0800A	8.0	8.0	82.0	38.0	31.0	2XDSCSM0800A	8.0	8.0	79.0	41.0	29.0
2XDSSM0810A	8.1	10.0	89.0	43.0	35.0	2XDSCSM0810A	8.1	10.0	89.0	47.0	35.0
2XDSSM0820A	8.2	10.0	89.0	43.0	35.0	2XDSCSM0820A	8.2	10.0	89.0	47.0	35.0
2XDSSM0830A	8.3	10.0	89.0	43.0	35.0	2XDSCSM0830A	8.3	10.0	89.0	47.0	35.0
2XDSSM0840A	8.4	10.0	89.0	43.0	35.0	2XDSCSM0840A	8.4	10.0	89.0	47.0	35.0
2XDSSM0850A	8.5	10.0	89.0	43.0	35.0	2XDSCSM0850A	8.5	10.0	89.0	47.0	35.0
2XDSSM0860A	8.6	10.0	89.0	43.0	35.0	2XDSCSM0860A	8.6	10.0	89.0	47.0	35.0
2XDSSM0870A	8.7	10.0	89.0	43.0	35.0	2XDSCSM0870A	8.7	10.0	89.0	47.0	35.0
2XDSSM0880A	8.8	10.0	89.0	43.0	35.0	2XDSCSM0880A	8.8	10.0	89.0	47.0	35.0
2XDSSM0890A	8.9	10.0	89.0	43.0	35.0	2XDSCSM0890A	8.9	10.0	89.0	47.0	35.0
2XDSSM0900A	9.0	10.0	89.0	43.0	35.0	2XDSCSM0900A	9.0	10.0	89.0	47.0	35.0
2XDSSM0910A	9.1	10.0	89.0	43.0	35.0	2XDSCSM0910A	9.1	10.0	89.0	47.0	35.0
2XDSSM0920A	9.2	10.0	89.0	43.0	35.0	2XDSCSM0920A	9.2	10.0	89.0	47.0	35.0
2XDSSM0925A	9.25	10.0	89.0	43.0	35.0	2XDSCSM0925A	9.25	10.0	89.0	47.0	35.0
2XDSSM0930A	9.3	10.0	89.0	43.0	35.0	2XDSCSM0930A	9.3	10.0	89.0	47.0	35.0
2XDSSM0940A	9.4	10.0	89.0	43.0	35.0	2XDSCSM0940A	9.4	10.0	89.0	47.0	35.0
2XDSSM0950A	9.5	10.0	89.0	43.0	35.0	2XDSCSM0950A	9.5	10.0	89.0	47.0	35.0
2XDSSM0960A	9.6	10.0	89.0	43.0	35.0	2XDSCSM0960A	9.6	10.0	89.0	47.0	35.0
2XDSSM0970A	9.7	10.0	89.0	43.0	35.0	2XDSCSM0970A	9.7	10.0	89.0	47.0	35.0
2XDSSM0980A	9.8	10.0	89.0	43.0	35.0	2XDSCSM0980A	9.8	10.0	89.0	47.0	35.0
2XDSSM0990A	9.9	10.0	89.0	43.0	35.0	2XDSCSM0990A	9.9	10.0	89.0	47.0	35.0
2XDSSM1000A	10.0	10.0	89.0	43.0	35.0	2XDSCSM1000A	10.0	10.0	89.0	47.0	35.0
2XDSSM1010A	10.1	12.0	101.0	51.0	41.0	2XDSCSM1010A	10.1	12.0	102.0	55.0	40.0
2XDSSM1020A	10.2	12.0	101.0	51.0	41.0	2XDSCSM1020A	10.2	12.0	102.0	55.0	40.0
2XDSSM1030A	10.3	12.0	101.0	51.0	41.0	2XDSCSM1030A	10.3	12.0	102.0	55.0	40.0
2XDSSM1040A	10.4	12.0	101.0	51.0	41.0	2XDSCSM1040A	10.4	12.0	102.0	55.0	40.0
2XDSSM1050A	10.5	12.0	101.0	51.0	41.0	2XDSCSM1050A	10.5	12.0	102.0	55.0	40.0
2XDSSM1060A	10.6	12.0	101.0	51.0	41.0	2XDSCSM1060A	10.6	12.0	102.0	55.0	40.0
2XDSSM1070A	10.7	12.0	101.0	51.0	41.0	2XDSCSM1070A	10.7	12.0	102.0	55.0	40.0
2XDSSM1080A	10.8	12.0	101.0	51.0	41.0	2XDSCSM1080A	10.8	12.0	102.0	55.0	40.0
2XDSSM1090A	10.9	12.0	101.0	51.0	41.0	2XDSCSM1090A	10.9	12.0	102.0	55.0	40.0
2XDSSM1100A	11.0	12.0	101.0	51.0	41.0	2XDSCSM1100A	11.0	12.0	102.0	55.0	40.0
2XDSSM1110A	11.1	12.0	101.0	51.0	41.0	2XDSCSM1110A	11.1	12.0	102.0	55.0	40.0

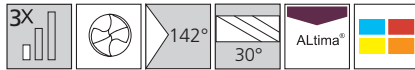
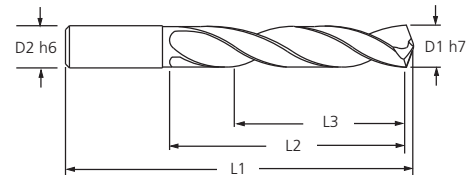
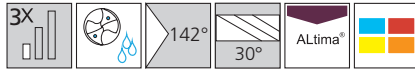

Twister® XD High Performance Drill - 3xD Series XDSSM & XDSCSM

Series XD SSM

Series XD CSM

Series 2XDSSM	Drill Dimensions XD SSM					Series 2XDSCSM	Drill Dimensions XD CSM				
Tool No.	Ø D1	Ø D2	L1	L2	L3	Tool No.	Ø D1	Ø D2	L1	L2	L3
2XDSSM1120A	11.2	12.0	101.0	51.0	41.0	2XDSCSM1120A	11.2	12.0	102.0	55.0	40.0
2XDSSM1130A	11.3	12.0	101.0	51.0	41.0	2XDSCSM1130A	11.3	12.0	102.0	55.0	40.0
2XDSSM1140A	11.4	12.0	101.0	51.0	41.0	2XDSCSM1140A	11.4	12.0	102.0	55.0	40.0
2XDSSM1150A	11.5	12.0	101.0	51.0	41.0	2XDSCSM1150A	11.5	12.0	102.0	55.0	40.0
2XDSSM1160A	11.6	12.0	101.0	51.0	41.0	2XDSCSM1160A	11.6	12.0	102.0	55.0	40.0
2XDSSM1170A	11.7	12.0	101.0	51.0	41.0	2XDSCSM1170A	11.7	12.0	102.0	55.0	40.0
2XDSSM1180A	11.8	12.0	101.0	51.0	41.0	2XDSCSM1180A	11.8	12.0	102.0	55.0	40.0
2XDSSM1190A	11.9	12.0	101.0	51.0	41.0	2XDSCSM1190A	11.9	12.0	102.0	55.0	40.0
2XDSSM1200A	12.0	12.0	101.0	51.0	41.0	2XDSCSM1200A	12.0	12.0	102.0	55.0	40.0
2XDSSM1210A	12.1	14.0	107.0	54.0	43.0	2XDSCSM1210A	12.1	14.0	107.0	60.0	43.0
2XDSSM1250A	12.5	14.0	107.0	54.0	43.0	2XDSCSM1250A	12.5	14.0	107.0	60.0	43.0
2XDSSM1280A	12.8	14.0	107.0	54.0	43.0	2XDSCSM1280A	12.8	14.0	107.0	60.0	43.0
2XDSSM1283A	12.83	14.0	107.0	54.0	43.0	2XDSCSM1283A	12.83	14.0	107.0	60.0	43.0
2XDSSM1290A	12.9	14.0	107.0	54.0	43.0	2XDSCSM1290A	12.9	14.0	107.0	60.0	43.0
2XDSSM1300A	13.0	14.0	107.0	54.0	43.0	2XDSCSM1300A	13.0	14.0	107.0	60.0	43.0
2XDSSM1350A	13.5	14.0	107.0	54.0	43.0	2XDSCSM1350A	13.5	14.0	107.0	60.0	43.0
2XDSSM1370A	13.7	14.0	107.0	54.0	43.0	2XDSCSM1370A	13.7	14.0	107.0	60.0	43.0
2XDSSM1400A	14.0	14.0	107.0	54.0	43.0	2XDSCSM1400A	14.0	14.0	107.0	60.0	43.0
2XDSSM1450A	14.5	16.0	117.0	60.0	48.0	2XDSCSM1450A	14.5	16.0	115.0	65.0	45.0
2XDSSM1470A	14.7	16.0	117.0	60.0	48.0	2XDSCSM1470A	14.7	16.0	115.0	65.0	45.0
2XDSSM1500A	15.0	16.0	117.0	60.0	48.0	2XDSCSM1500A	15.0	16.0	115.0	65.0	45.0
2XDSSM1530A	15.3	16.0	117.0	60.0	48.0	2XDSCSM1530A	15.3	16.0	115.0	65.0	45.0
2XDSSM1550A	15.5	16.0	117.0	60.0	48.0	2XDSCSM1550A	15.5	16.0	115.0	65.0	45.0
2XDSSM1570A	15.7	16.0	117.0	60.0	48.0	2XDSCSM1570A	15.7	16.0	115.0	65.0	45.0
2XDSSM1600A	16.0	16.0	117.0	60.0	48.0	2XDSCSM1600A	16.0	16.0	115.0	65.0	45.0
2XDSSM1608A	16.08	18.0	122.0	63.0	51.0						
2XDSSM1630A	16.3	18.0	122.0	63.0	51.0						
2XDSSM1650A	16.5	18.0	122.0	63.0	51.0						
2XDSSM1700A	17.0	18.0	122.0	63.0	51.0						
2XDSSM1750A	17.5	18.0	122.0	63.0	51.0						
2XDSSM1800A	18.0	18.0	122.0	63.0	51.0						
2XDSSM1850A	18.5	20.0	133.0	70.0	56.0						
2XDSSM1916A	19.16	20.0	133.0	70.0	56.0						
2XDSSM1925A	19.25	20.0	133.0	70.0	56.0						
2XDSSM1930A	19.3	20.0	133.0	70.0	56.0						
2XDSSM1950A	19.5	20.0	133.0	70.0	56.0						
2XDSSM2000A	20.0	20.0	133.0	70.0	56.0						

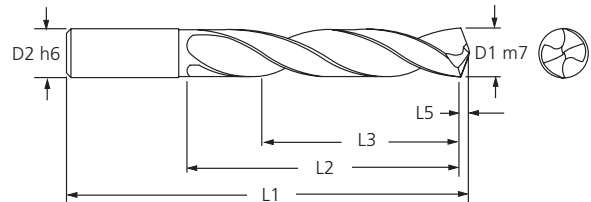
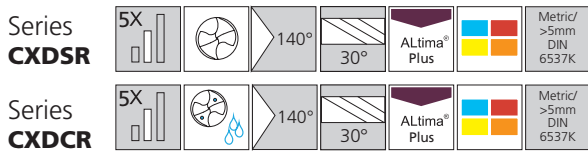

CYCLONE CXD High Performance Drill - 5xD Series CXDSR & CXDCR



Tool No.		Drill Dimensions (mm)					
CXDSR	CXDCR	Ø D1	Ø D2	L1	L2 (Max.)	L3	L5
CXDSR 0300AP	CXDCR 0300AP	3.0	3.0	66.0	28.0	23.0	0.46
CXDSR 0310AP	CXDCR 0310AP	3.1	4.0	66.0	28.0	23.0	0.48
CXDSR 0320AP	CXDCR 0320AP	3.2	4.0	66.0	28.0	23.0	0.5
CXDSR 0330AP	CXDCR 0330AP	3.3	4.0	66.0	28.0	23.0	0.51
CXDSR 0340AP	CXDCR 0340AP	3.4	4.0	66.0	28.0	23.0	0.53
CXDSR 0350AP	CXDCR 0350AP	3.5	4.0	66.0	28.0	23.0	0.54
CXDSR 0360AP	CXDCR 0360AP	3.6	4.0	66.0	28.0	23.0	0.56
CXDSR 0370AP	CXDCR 0370AP	3.7	4.0	66.0	28.0	23.0	0.57
CXDSR 0380AP	CXDCR 0380AP	3.8	4.0	74.0	36.0	29.0	0.59
CXDSR 0390AP	CXDCR 0390AP	3.9	4.0	74.0	36.0	29.0	0.6
CXDSR 0400AP	CXDCR 0400AP	4.0	4.0	74.0	36.0	29.0	0.62
CXDSR 0410AP	CXDCR 0410AP	4.1	5.0	74.0	36.0	29.0	0.64
CXDSR 0420AP	CXDCR 0420AP	4.2	5.0	74.0	36.0	29.0	0.65
CXDSR 0430AP	CXDCR 0430AP	4.3	5.0	74.0	36.0	29.0	0.67
CXDSR 0440AP	CXDCR 0440AP	4.4	5.0	74.0	36.0	29.0	0.68
CXDSR 0450AP	CXDCR 0450AP	4.5	5.0	74.0	36.0	29.0	0.7
CXDSR 0460AP	CXDCR 0460AP	4.6	5.0	74.0	36.0	29.0	0.71
CXDSR 0470AP	CXDCR 0470AP	4.7	5.0	74.0	36.0	29.0	0.73
CXDSR 0480AP	CXDCR 0480AP	4.8	5.0	82.0	44.0	35.0	0.74
CXDSR 0490AP	CXDCR 0490AP	4.9	5.0	82.0	44.0	35.0	0.76
CXDSR 0500AP	CXDCR 0500AP	5.0	5.0	82.0	44.0	35.0	0.77
CXDSR 0510AP	CXDCR 0510AP	5.1	6.0	82.0	44.0	35.0	0.79
CXDSR 0520AP	CXDCR 0520AP	5.2	6.0	82.0	44.0	35.0	0.81
CXDSR 0530AP	CXDCR 0530AP	5.3	6.0	82.0	44.0	35.0	0.82
CXDSR 0540AP	CXDCR 0540AP	5.4	6.0	82.0	44.0	35.0	0.84
CXDSR 0550AP	CXDCR 0550AP	5.5	6.0	82.0	44.0	35.0	0.85
CXDSR 0560AP	CXDCR 0560AP	5.6	6.0	82.0	44.0	35.0	0.86
CXDSR 0570AP	CXDCR 0570AP	5.7	6.0	82.0	44.0	35.0	0.88
CXDSR 0580AP	CXDCR 0580AP	5.8	6.0	82.0	44.0	35.0	0.9
CXDSR 0590AP	CXDCR 0590AP	5.9	6.0	82.0	44.0	35.0	0.91
CXDSR 0600AP	CXDCR 0600AP	6.0	6.0	82.0	44.0	35.0	0.93
CXDSR 0610AP	CXDCR 0610AP	6.1	8.0	91.0	53.0	43.0	0.95
CXDSR 0620AP	CXDCR 0620AP	6.2	8.0	91.0	53.0	43.0	0.96
CXDSR 0630AP	CXDCR 0630AP	6.3	8.0	91.0	53.0	43.0	0.98
CXDSR 0640AP	CXDCR 0640AP	6.4	8.0	91.0	53.0	43.0	0.99
CXDSR 0650AP	CXDCR 0650AP	6.5	8.0	91.0	53.0	43.0	1.01
CXDSR 0660AP	CXDCR 0660AP	6.6	8.0	91.0	53.0	43.0	1.03
CXDSR 0670AP	CXDCR 0670AP	6.7	8.0	91.0	53.0	43.0	1.04
CXDSR 0680AP	CXDCR 0680AP	6.8	8.0	91.0	53.0	43.0	1.05
CXDSR 0690AP	CXDCR 0690AP	6.9	8.0	91.0	53.0	43.0	1.07



CYCLONE CXD High Performance Drill - 5xD Series CXDSR & CXDCR

Series CXDSR							Metric/ >5mm DIN 6537K
Series CXDCR							Metric/ >5mm DIN 6537K

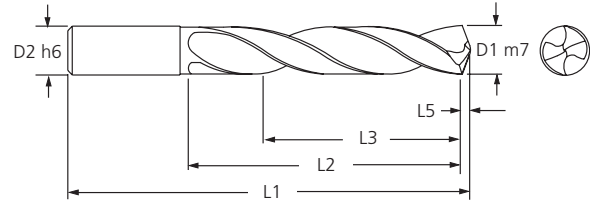

Tool No.		Drill Dimensions (mm)					
CXDSR	CXDCR	Ø D1	Ø D2	L1	L2 (Max.)	L3	L5
CXDSR 0700AP	CXDCR 0700AP	7.0	8.0	91.0	53.0	43.0	1.08
CXDSR 0710AP	CXDCR 0710AP	7.1	8.0	91.0	53.0	43.0	1.1
CXDSR 0720AP	CXDCR 0720AP	7.2	8.0	91.0	53.0	43.0	1.12
CXDSR 0730AP	CXDCR 0730AP	7.3	8.0	91.0	53.0	43.0	1.13
CXDSR 0740AP	CXDCR 0740AP	7.4	8.0	91.0	53.0	43.0	1.15
CXDSR 0750AP	CXDCR 0750AP	7.5	8.0	91.0	53.0	43.0	1.16
CXDSR 0760AP	CXDCR 0760AP	7.6	8.0	91.0	53.0	43.0	1.18
CXDSR 0770AP	CXDCR 0770AP	7.7	8.0	91.0	53.0	43.0	1.19
CXDSR 0780AP	CXDCR 0780AP	7.8	8.0	91.0	53.0	43.0	1.21
CXDSR 0790AP	CXDCR 0790AP	7.9	8.0	91.0	53.0	43.0	1.22
CXDSR 0800AP	CXDCR 0800AP	8.0	8.0	91.0	53.0	43.0	1.24
CXDSR 0810AP	CXDCR 0810AP	8.1	10.0	103.0	61.0	49.0	1.26
CXDSR 0820AP	CXDCR 0820AP	8.2	10.0	103.0	61.0	49.0	1.27
CXDSR 0830AP	CXDCR 0830AP	8.3	10.0	103.0	61.0	49.0	1.29
CXDSR 0840AP	CXDCR 0840AP	8.4	10.0	103.0	61.0	49.0	1.31
CXDSR 0850AP	CXDCR 0850AP	8.5	10.0	103.0	61.0	49.0	1.32
CXDSR 0860AP	CXDCR 0860AP	8.6	10.0	103.0	61.0	49.0	1.33
CXDSR 0870AP	CXDCR 0870AP	8.7	10.0	103.0	61.0	49.0	1.35
CXDSR 0880AP	CXDCR 0880AP	8.8	10.0	103.0	61.0	49.0	1.36
CXDSR 0890AP	CXDCR 0890AP	8.9	10.0	103.0	61.0	49.0	1.38
CXDSR 0900AP	CXDCR 0900AP	9.0	10.0	103.0	61.0	49.0	1.39
CXDSR 0910AP	CXDCR 0910AP	9.1	10.0	103.0	61.0	49.0	1.41
CXDSR 0920AP	CXDCR 0920AP	9.2	10.0	103.0	61.0	49.0	1.43
CXDSR 0925AP	CXDCR 0925AP	9.3	10.0	103.0	61.0	49.0	1.43
CXDSR 0930AP	CXDCR 0930AP	9.3	10.0	103.0	61.0	49.0	1.44
CXDSR 0940AP	CXDCR 0940AP	9.4	10.0	103.0	61.0	49.0	1.46
CXDSR 0950AP	CXDCR 0950AP	9.5	10.0	103.0	61.0	49.0	1.47
CXDSR 0960AP	CXDCR 0960AP	9.6	10.0	103.0	61.0	49.0	1.49
CXDSR 0970AP	CXDCR 0970AP	9.7	10.0	103.0	61.0	49.0	1.5
CXDSR 0980AP	CXDCR 0980AP	9.8	10.0	103.0	61.0	49.0	1.52
CXDSR 0990AP	CXDCR 0990AP	9.9	10.0	103.0	61.0	49.0	1.53
CXDSR 1000AP	CXDCR 1000AP	10.0	10.0	103.0	61.0	49.0	1.55
CXDSR 1010AP	CXDCR 1010AP	10.1	12.0	118.0	71.0	56.0	1.56
CXDSR 1020AP	CXDCR 1020AP	10.2	12.0	118.0	71.0	56.0	1.58
CXDSR 1030AP	CXDCR 1030AP	10.3	12.0	118.0	71.0	56.0	1.6
CXDSR 1040AP	CXDCR 1040AP	10.4	12.0	118.0	71.0	56.0	1.61
CXDSR 1050AP	CXDCR 1050AP	10.5	12.0	118.0	71.0	56.0	1.63
CXDSR 1060AP	CXDCR 1060AP	10.6	12.0	118.0	71.0	56.0	1.64
CXDSR 1070AP	CXDCR 1070AP	10.7	12.0	118.0	71.0	56.0	1.66
CXDSR 1080AP	CXDCR 1080AP	10.8	12.0	118.0	71.0	56.0	1.67

CYCLONE CXD High Performance Drill - 5xD Series CXDSR & CXDCR

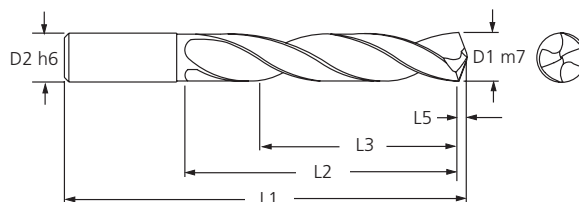
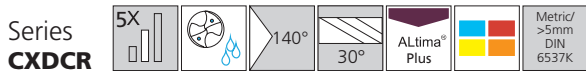
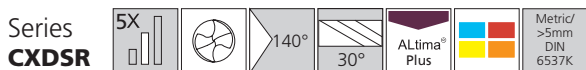

Tool No.		Drill Dimensions (mm)					
CXDSR	CXDCR	Ø D1	Ø D2	L1	L2 (Max.)	L3	L5
CXDSR 1090AP	CXDCR 1090AP	10.9	12.0	118.0	71.0	56.0	1.69
CXDSR 1100AP	CXDCR 1100AP	11.0	12.0	118.0	71.0	56.0	1.7
CXDSR 1110AP	CXDCR 1110AP	11.1	12.0	118.0	71.0	56.0	1.72
CXDSR 1120AP	CXDCR 1120AP	11.2	12.0	118.0	71.0	56.0	1.74
CXDSR 1130AP	CXDCR 1130AP	11.3	12.0	118.0	71.0	56.0	1.75
CXDSR 1140AP	CXDCR 1140AP	11.4	12.0	118.0	71.0	56.0	1.77
CXDSR 1150AP	CXDCR 1150AP	11.5	12.0	118.0	71.0	56.0	1.78
CXDSR 1160AP	CXDCR 1160AP	11.6	12.0	118.0	71.0	56.0	1.8
CXDSR 1170AP	CXDCR 1170AP	11.7	12.0	118.0	71.0	56.0	1.81
CXDSR 1180AP	CXDCR 1180AP	11.8	12.0	118.0	71.0	56.0	1.83
CXDSR 1190AP	CXDCR 1190AP	11.9	12.0	118.0	71.0	56.0	1.84
CXDSR 1200AP	CXDCR 1200AP	12.0	12.0	118.0	71.0	56.0	1.86
CXDSR 1210AP	CXDCR 1210AP	12.1	14.0	124.0	77.0	60.0	1.87
CXDSR 1250AP	CXDCR 1250AP	12.5	14.0	124.0	77.0	60.0	1.94
CXDSR 1280AP	CXDCR 1280AP	12.8	14.0	124.0	77.0	60.0	1.98
CXDSR 1283AP	CXDCR 1283AP	12.8	14.0	124.0	77.0	60.0	1.99
CXDSR 1290AP	CXDCR 1290AP	12.9	14.0	124.0	77.0	60.0	2.0
CXDSR 1300AP	CXDCR 1300AP	13.0	14.0	124.0	77.0	60.0	2.01
CXDSR 1350AP	CXDCR 1350AP	13.5	14.0	124.0	77.0	60.0	2.09
CXDSR 1370AP	CXDCR 1370AP	13.7	14.0	124.0	77.0	60.0	2.12
CXDSR 1400AP	CXDCR 1400AP	14.0	14.0	124.0	77.0	60.0	2.17
CXDSR 1450AP	CXDCR 1450AP	14.5	16.0	133.0	83.0	63.0	2.25
CXDSR 1470AP	CXDCR 1470AP	14.7	16.0	133.0	83.0	63.0	2.28
CXDSR 1500AP	CXDCR 1500AP	15.0	16.0	133.0	83.0	63.0	2.32
CXDSR 1530AP	CXDCR 1530AP	15.3	16.0	133.0	83.0	63.0	2.37
CXDSR 1550AP	CXDCR 1550AP	15.5	16.0	133.0	83.0	63.0	2.4
CXDSR 1570AP	CXDCR 1570AP	15.7	16.0	133.0	83.0	63.0	2.43
CXDSR 1600AP	CXDCR 1600AP	16.0	16.0	133.0	83.0	63.0	2.48
-	CXDCR 1608AP	16.08	18.0	143.0	93.0	71.0	2.49
-	CXDCR 1630AP	16.3	18.0	143.0	93.0	71.0	2.53
-	CXDCR 1650AP	16.5	18.0	143.0	93.0	71.0	2.56
-	CXDCR 1700AP	17.0	18.0	143.0	93.0	71.0	2.63
-	CXDCR 1750AP	17.5	18.0	143.0	93.0	71.0	2.71
-	CXDCR 1800AP	18.0	18.0	143.0	93.0	71.0	2.79
-	CXDCR 1850AP	18.5	20.0	153.0	101.0	79.0	2.87
-	CXDCR 1916AP	19.16	20.0	153.0	101.0	79.0	2.97
-	CXDCR 1925AP	19.25	20.0	153.0	101.0	79.0	2.98
-	CXDCR 1930AP	19.3	20.0	153.0	101.0	79.0	2.99
-	CXDCR 1950AP	19.5	20.0	153.0	101.0	79.0	3.02
-	CXDCR 2000AP	20.0	20.0	153.0	101.0	79.0	3.1



Twister® XD High Performance Drill - 5xD Series XDSRM & XDCRM

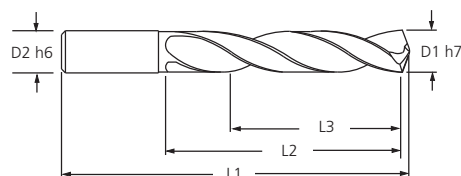

Series 2XD SRM	Drill Dimensions XD SRM					Series 2XD CRM	Drill Dimensions XD CRM				
Tool No.	Ø D1	Ø D2	L1	L2	L3	Tool No.	Ø D1	Ø D2	L1	L2	L3
2XD SRM0050A	0.5	0.5	26.0	6.0	5.0	-	-	-	-	-	-
2XD SRM0060A	0.6	0.6	26.0	7.0	5.0	-	-	-	-	-	-
2XD SRM0065A	0.65	0.65	26.0	8.0	6.0	-	-	-	-	-	-
2XD SRM0095A	0.95	0.95	32.0	11.0	8.0	-	-	-	-	-	-
2XD SRM0100A	1.0	1.0	34.0	12.0	9.0	-	-	-	-	-	-
2XD SRM0105A	1.05	1.05	34.0	12.0	9.0	-	-	-	-	-	-
2XD SRM0125A	1.25	1.25	38.0	16.0	12.0	-	-	-	-	-	-
2XD SRM0150A	1.5	1.5	40.0	18.0	14.0	-	-	-	-	-	-
2XD SRM0160A	1.6	1.6	43.0	20.0	15.0	-	-	-	-	-	-
2XD SRM0180A	1.8	1.8	46.0	22.0	17.0	-	-	-	-	-	-
2XD SRM0190A	1.9	1.9	46.0	22.0	17.0	-	-	-	-	-	-
2XD SRM0200A	2.0	2.0	49.0	24.0	18.0	-	-	-	-	-	-
2XD SRM0205A	2.05	2.05	49.0	24.0	18.0	-	-	-	-	-	-
2XD SRM0230A	2.3	2.3	53.0	27.0	20.0	-	-	-	-	-	-
2XD SRM0240A	2.4	2.4	57.0	30.0	23.0	-	-	-	-	-	-
2XD SRM0250A	2.5	2.5	57.0	30.0	23.0	-	-	-	-	-	-
2XD SRM0290A	2.9	2.9	61.0	33.0	25.0	-	-	-	-	-	-
2XD SRM0300A	3.0	3.0	63.0	24.0	19.0	2XD CRM0300A	3.0	3.0	75.0	24.0	19.0
2XD SRM0310A	3.1	4.0	69.0	32.0	26.0	2XD CRM0310A	3.1	4.0	80.0	32.0	26.0
2XD SRM0320A	3.2	4.0	69.0	32.0	26.0	2XD CRM0320A	3.2	4.0	80.0	32.0	26.0
2XD SRM0330A	3.3	4.0	69.0	32.0	26.0	2XD CRM0330A	3.3	4.0	80.0	32.0	26.0
2XD SRM0340A	3.4	4.0	69.0	32.0	26.0	2XD CRM0340A	3.4	4.0	80.0	32.0	26.0
2XD SRM0350A	3.5	4.0	69.0	32.0	26.0	2XD CRM0350A	3.5	4.0	80.0	32.0	26.0
2XD SRM0360A	3.6	4.0	69.0	32.0	26.0	2XD CRM0360A	3.6	4.0	80.0	32.0	26.0
2XD SRM0370A	3.7	4.0	69.0	32.0	26.0	2XD CRM0370A	3.7	4.0	80.0	32.0	26.0
2XD SRM0380A	3.8	4.0	69.0	32.0	26.0	2XD CRM0380A	3.8	4.0	80.0	32.0	26.0
2XD SRM0390A	3.9	4.0	69.0	32.0	26.0	2XD CRM0390A	3.9	4.0	80.0	32.0	26.0
2XD SRM0400A	4.0	4.0	69.0	32.0	26.0	2XD CRM0400A	4.0	4.0	80.0	32.0	26.0
2XD SRM0410A	4.1	5.0	80.0	38.0	30.0	2XD CRM0410A	4.1	5.0	82.0	38.0	30.0
2XD SRM0420A	4.2	5.0	80.0	38.0	30.0	2XD CRM0420A	4.2	5.0	82.0	38.0	30.0
2XD SRM0430A	4.3	5.0	80.0	38.0	30.0	2XD CRM0430A	4.3	5.0	82.0	38.0	30.0
2XD SRM0440A	4.4	5.0	80.0	38.0	30.0	2XD CRM0440A	4.4	5.0	82.0	38.0	30.0
2XD SRM0450A	4.5	5.0	80.0	38.0	30.0	2XD CRM0450A	4.5	5.0	82.0	38.0	30.0
2XD SRM0460A	4.6	5.0	80.0	38.0	30.0	2XD CRM0460A	4.6	5.0	82.0	38.0	30.0
2XD SRM0470A	4.7	5.0	80.0	38.0	30.0	2XD CRM0470A	4.7	5.0	82.0	38.0	30.0
2XD SRM0480A	4.8	5.0	80.0	38.0	30.0	2XD CRM0480A	4.8	5.0	82.0	38.0	30.0
2XD SRM0490A	4.9	5.0	80.0	38.0	30.0	2XD CRM0490A	4.9	5.0	82.0	38.0	30.0
2XD SRM0500A	5.0	5.0	80.0	38.0	30.0	2XD CRM0500A	5.0	5.0	82.0	38.0	30.0
2XD SRM0510A	5.1	6.0	82.0	40.0	32.0	2XD CRM0510A	5.1	6.0	82.0	40.0	32.0
2XD SRM0520A	5.2	6.0	82.0	40.0	32.0	2XD CRM0520A	5.2	6.0	82.0	40.0	32.0
2XD SRM0530A	5.3	6.0	82.0	40.0	32.0	2XD CRM0530A	5.3	6.0	82.0	40.0	32.0
2XD SRM0540A	5.4	6.0	82.0	40.0	32.0	2XD CRM0540A	5.4	6.0	82.0	40.0	32.0
2XD SRM0550A	5.5	6.0	82.0	40.0	32.0	2XD CRM0550A	5.5	6.0	82.0	40.0	32.0

Twister® XD High Performance Drill - 5xD Series XDSRM & XDCRM

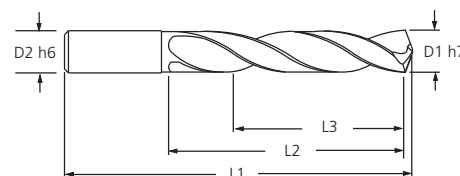
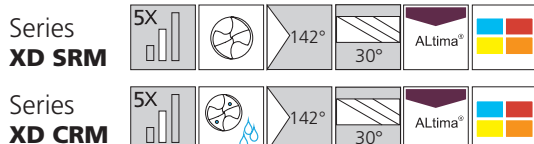

Series 2XD5SRM	Drill Dimensions XD SRM					Series 2XDCRM	Drill Dimensions XD CRM				
Tool No.	Ø D1	Ø D2	L1	L2	L3	Tool No.	Ø D1	Ø D2	L1	L2	L3
2XD5SRM0570A	5.7	6.0	82.0	40.0	32.0	2XD5CRM0570A	5.7	6.0	82.0	40.0	32.0
2XD5SRM0580A	5.8	6.0	82.0	40.0	32.0	2XD5CRM0580A	5.8	6.0	82.0	40.0	32.0
2XD5SRM0590A	5.9	6.0	82.0	40.0	32.0	2XD5CRM0590A	5.9	6.0	82.0	40.0	32.0
2XD5SRM0600A	6.0	6.0	82.0	40.0	32.0	2XD5CRM0600A	6.0	6.0	82.0	40.0	32.0
2XD5SRM0610A	6.1	8.0	91.0	48.0	38.0	2XD5CRM0610A	6.1	8.0	91.0	48.0	38.0
2XD5SRM0620A	6.2	8.0	91.0	48.0	38.0	2XD5CRM0620A	6.2	8.0	91.0	48.0	38.0
2XD5SRM0630A	6.3	8.0	91.0	48.0	38.0	2XD5CRM0630A	6.3	8.0	91.0	48.0	38.0
2XD5SRM0640A	6.4	8.0	91.0	48.0	38.0	2XD5CRM0640A	6.4	8.0	91.0	48.0	38.0
2XD5SRM0650A	6.5	8.0	91.0	48.0	38.0	2XD5CRM0650A	6.5	8.0	91.0	48.0	38.0
2XD5SRM0660A	6.6	8.0	91.0	48.0	38.0	2XD5CRM0660A	6.6	8.0	91.0	48.0	38.0
2XD5SRM0670A	6.7	8.0	91.0	48.0	38.0	2XD5CRM0670A	6.7	8.0	91.0	48.0	38.0
2XD5SRM0680A	6.8	8.0	91.0	48.0	38.0	2XD5CRM0680A	6.8	8.0	91.0	48.0	38.0
2XD5SRM0690A	6.9	8.0	91.0	48.0	38.0	2XD5CRM0690A	6.9	8.0	91.0	48.0	38.0
2XD5SRM0700A	7.0	8.0	91.0	48.0	38.0	2XD5CRM0700A	7.0	8.0	91.0	48.0	38.0
2XD5SRM0710A	7.1	8.0	91.0	48.0	38.0	2XD5CRM0710A	7.1	8.0	91.0	48.0	38.0
2XD5SRM0720A	7.2	8.0	91.0	48.0	38.0	2XD5CRM0720A	7.2	8.0	91.0	48.0	38.0
2XD5SRM0730A	7.3	8.0	91.0	48.0	38.0	2XD5CRM0730A	7.3	8.0	91.0	48.0	38.0
2XD5SRM0740A	7.4	8.0	91.0	48.0	38.0	2XD5CRM0740A	7.4	8.0	91.0	48.0	38.0
2XD5SRM0750A	7.5	8.0	91.0	48.0	38.0	2XD5CRM0750A	7.5	8.0	91.0	48.0	38.0
2XD5SRM0760A	7.6	8.0	91.0	48.0	38.0	2XD5CRM0760A	7.6	8.0	91.0	48.0	38.0
2XD5SRM0770A	7.7	8.0	91.0	48.0	38.0	2XD5CRM0770A	7.7	8.0	91.0	48.0	38.0
2XD5SRM0780A	7.8	8.0	91.0	48.0	38.0	2XD5CRM0780A	7.8	8.0	91.0	48.0	38.0
2XD5SRM0790A	7.9	8.0	91.0	48.0	38.0	2XD5CRM0790A	7.9	8.0	91.0	48.0	38.0
2XD5SRM0800A	8.0	8.0	91.0	48.0	38.0	2XD5CRM0800A	8.0	8.0	91.0	48.0	38.0
2XD5SRM0810A	8.1	10.0	103.0	55.0	44.0	2XD5CRM0810A	8.1	10.0	103.0	55.0	44.0
2XD5SRM0820A	8.2	10.0	103.0	55.0	44.0	2XD5CRM0820A	8.2	10.0	103.0	55.0	44.0
2XD5SRM0830A	8.3	10.0	103.0	55.0	44.0	2XD5CRM0830A	8.3	10.0	103.0	55.0	44.0
2XD5SRM0840A	8.4	10.0	103.0	55.0	44.0	2XD5CRM0840A	8.4	10.0	103.0	55.0	44.0
2XD5SRM0850A	8.5	10.0	103.0	55.0	44.0	2XD5CRM0850A	8.5	10.0	103.0	55.0	44.0
2XD5SRM0860A	8.6	10.0	103.0	55.0	44.0	2XD5CRM0860A	8.6	10.0	103.0	55.0	44.0
2XD5SRM0870A	8.7	10.0	103.0	55.0	44.0	2XD5CRM0870A	8.7	10.0	103.0	55.0	44.0
2XD5SRM0880A	8.8	10.0	103.0	55.0	44.0	2XD5CRM0880A	8.8	10.0	103.0	55.0	44.0
2XD5SRM0890A	8.9	10.0	103.0	55.0	44.0	2XD5CRM0890A	8.9	10.0	103.0	55.0	44.0
2XD5SRM0900A	9.0	10.0	103.0	55.0	44.0	2XD5CRM0900A	9.0	10.0	103.0	55.0	44.0
2XD5SRM0910A	9.1	10.0	103.0	55.0	44.0	2XD5CRM0910A	9.1	10.0	103.0	55.0	44.0
2XD5SRM0920A	9.2	10.0	103.0	55.0	44.0	2XD5CRM0920A	9.2	10.0	103.0	55.0	44.0
2XD5SRM0925A	9.25	10.0	103.0	55.0	44.0	2XD5CRM0925A	9.25	10.0	103.0	55.0	44.0
2XD5SRM0930A	9.3	10.0	103.0	55.0	44.0	2XD5CRM0930A	9.3	10.0	103.0	55.0	44.0
2XD5SRM0940A	9.4	10.0	103.0	55.0	44.0	2XD5CRM0940A	9.4	10.0	103.0	55.0	44.0
2XD5SRM0950A	9.5	10.0	103.0	55.0	44.0	2XD5CRM0950A	9.5	10.0	103.0	55.0	44.0
2XD5SRM0960A	9.6	10.0	103.0	55.0	44.0	2XD5CRM0960A	9.6	10.0	103.0	55.0	44.0
2XD5SRM0970A	9.7	10.0	103.0	55.0	44.0	2XD5CRM0970A	9.7	10.0	103.0	55.0	44.0
2XD5SRM0980A	9.8	10.0	103.0	55.0	44.0	2XD5CRM0980A	9.8	10.0	103.0	55.0	44.0



Twister® XD High Performance Drill - 5xD Series XDSRM & XDCRM

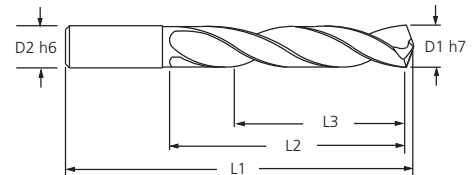

Series 2XDSRM	Drill Dimensions XD SRM					Series 2XDCRM	Drill Dimensions XD CRM				
Tool No.	Ø D1	Ø D2	L1	L2	L3	Tool No.	Ø D1	Ø D2	L1	L2	L3
2XDSRM0990A	9.9	10.0	103.0	55.0	44.0	2XDCRM0990A	9.9	10.0	103.0	55.0	44.0
2XDSRM1000A	10.0	10.0	103.0	55.0	44.0	2XDCRM1000A	10.0	10.0	103.0	55.0	44.0
2XDSRM1010A	10.1	12.0	120.0	60.0	48.0	2XDCRM1010A	10.1	12.0	120.0	60.0	48.0
2XDSRM1020A	10.2	12.0	120.0	60.0	48.0	2XDCRM1020A	10.2	12.0	120.0	60.0	48.0
2XDSRM1030A	10.3	12.0	120.0	60.0	48.0	2XDCRM1030A	10.3	12.0	120.0	60.0	48.0
2XDSRM1040A	10.4	12.0	120.0	60.0	48.0	2XDCRM1040A	10.4	12.0	120.0	60.0	48.0
2XDSRM1050A	10.5	12.0	120.0	60.0	48.0	2XDCRM1050A	10.5	12.0	120.0	60.0	48.0
2XDSRM1060A	10.6	12.0	120.0	60.0	48.0	2XDCRM1060A	10.6	12.0	120.0	60.0	48.0
2XDSRM1070A	10.7	12.0	120.0	60.0	48.0	2XDCRM1070A	10.7	12.0	120.0	60.0	48.0
2XDSRM1080A	10.8	12.0	120.0	60.0	48.0	2XDCRM1080A	10.8	12.0	120.0	60.0	48.0
2XDSRM1090A	10.9	12.0	120.0	60.0	48.0	2XDCRM1090A	10.9	12.0	120.0	60.0	48.0
2XDSRM1100A	11.0	12.0	120.0	60.0	48.0	2XDCRM1100A	11.0	12.0	120.0	60.0	48.0
2XDSRM1110A	11.1	12.0	120.0	60.0	48.0	2XDCRM1110A	11.1	12.0	120.0	66.0	53.0
2XDSRM1120A	11.2	12.0	120.0	60.0	48.0	2XDCRM1120A	11.2	12.0	120.0	66.0	53.0
2XDSRM1130A	11.3	12.0	120.0	60.0	48.0	2XDCRM1130A	11.3	12.0	120.0	66.0	53.0
2XDSRM1140A	11.4	12.0	120.0	60.0	48.0	2XDCRM1140A	11.4	12.0	120.0	66.0	53.0
2XDSRM1150A	11.5	12.0	120.0	60.0	48.0	2XDCRM1150A	11.5	12.0	120.0	66.0	53.0
2XDSRM1160A	11.6	12.0	120.0	60.0	48.0	2XDCRM1160A	11.6	12.0	120.0	66.0	53.0
2XDSRM1170A	11.7	12.0	120.0	60.0	48.0	2XDCRM1170A	11.7	12.0	120.0	66.0	53.0
2XDSRM1180A	11.8	12.0	120.0	60.0	48.0	2XDCRM1180A	11.8	12.0	120.0	66.0	53.0
2XDSRM1190A	11.9	12.0	120.0	60.0	48.0	2XDCRM1190A	11.9	12.0	120.0	66.0	53.0
2XDSRM1200A	12.0	12.0	120.0	66.0	53.0	2XDCRM1200A	12.0	12.0	120.0	66.0	53.0
2XDSRM1210A	12.1	14.0	126.0	72.0	58.0	2XDCRM1210A	12.1	14.0	126.0	72.0	58.0
2XDSRM1250A	12.5	14.0	126.0	72.0	58.0	2XDCRM1250A	12.5	14.0	126.0	72.0	58.0
2XDSRM1280A	12.8	14.0	126.0	72.0	58.0	2XDCRM1280A	12.8	14.0	126.0	72.0	58.0
2XDSRM1290A	12.9	14.0	126.0	72.0	58.0	2XDCRM1290A	12.9	14.0	126.0	72.0	58.0
2XDSRM1300A	13.0	14.0	126.0	72.0	58.0	2XDCRM1300A	13.0	14.0	126.0	72.0	58.0
2XDSRM1350A	13.5	14.0	134.0	77.0	62.0	2XDCRM1350A	13.5	14.0	134.0	77.0	62.0
2XDSRM1370A	13.7	14.0	134.0	77.0	62.0	2XDCRM1370A	13.7	14.0	134.0	77.0	62.0
2XDSRM1400A	14.0	14.0	134.0	77.0	62.0	2XDCRM1400A	14.0	14.0	134.0	77.0	62.0
2XDSRM1450A	14.5	16.0	140.0	80.0	64.0	2XDCRM1450A	14.5	16.0	140.0	80.0	64.0
2XDSRM1470A	14.7	16.0	140.0	80.0	64.0	2XDCRM1470A	14.7	16.0	140.0	80.0	64.0
2XDSRM1500A	15.0	16.0	140.0	80.0	64.0	2XDCRM1500A	15.0	16.0	140.0	80.0	64.0
2XDSRM1530A	15.3	16.0	146.0	82.0	66.0	2XDCRM1530A	15.3	16.0	146.0	82.0	66.0
2XDSRM1550A	15.5	16.0	146.0	82.0	66.0	2XDCRM1550A	15.5	16.0	146.0	82.0	66.0
2XDSRM1570A	15.7	16.0z	146.0	82.0	66.0	2XDCRM1570A	15.7	16.0	146.0	82.0	66.0
2XDSRM1600A	16.0	16.0	146.0	82.0	66.0	2XDCRM1600A	16.0	16.0	146.0	82.0	66.0
-	-	-	-	-	-	2XDCRM1608A	16.08	18.0	158.0	90.0	72.0
-	-	-	-	-	-	2XDCRM1630A	16.3	18.0	158.0	90.0	72.0
-	-	-	-	-	-	2XDCRM1650A	16.5	18.0	158.0	90.0	72.0
-	-	-	-	-	-	2XDCRM1700A	17.0	18.0	158.0	90.0	72.0
-	-	-	-	-	-	2XDCRM1750A	17.5	18.0	158.0	95.0	76.0
-	-	-	-	-	-	2XDCRM1800A	18.0	18.0	158.0	95.0	76.0

Twister[®] XD High Performance Drill - 5xD Series XDSRM & XD CRM

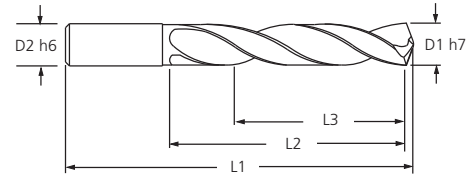
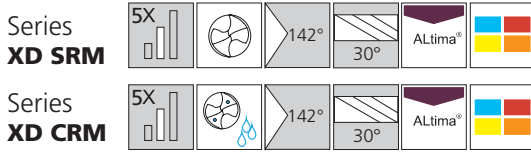

Series 2XD SRM	Drill Dimensions XD SRM					Series 2XD CRM	Drill Dimensions XD CRM				
Tool No.	Ø D1	Ø D2	L1	L2	L3	Tool No.	Ø D1	Ø D2	L1	L2	L3
-	-	-	-	-	-	2XD CRM1850A	18.5	20.0	160.0	100.0	80.0
-	-	-	-	-	-	2XD CRM1916A	19.16	20.0	160.0	100.0	80.0
-	-	-	-	-	-	2XD CRM1925A	19.25	20.0	160.0	100.0	80.0
-	-	-	-	-	-	2XD CRM1930A	19.3	20.0	160.0	100.0	80.0
-	-	-	-	-	-	2XD CRM1950A	19.5	20.0	160.0	100.0	80.0
-	-	-	-	-	-	2XD CRM2000A	20.0	20.0	160.0	100.0	80.0



Twister[®] XD High Performance Drill - 7+xD Series XDCLM

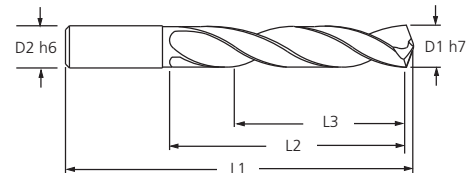
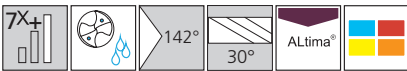

Series 2XDCLM	Drill Dimensions XD CLM				
Tool No.	Ø D1	Ø D2	L1	L2	L3
2XDCLM0300A	3.0	3.0	81.0	33.0	26.0
2XDCLM0310A	3.1	4.0	92.0	44.0	35.0
2XDCLM0320A	3.2	4.0	92.0	44.0	35.0
2XDCLM0330A	3.3	4.0	92.0	44.0	35.0
2XDCLM0340A	3.4	4.0	92.0	44.0	35.0
2XDCLM0350A	3.5	4.0	92.0	44.0	35.0
2XDCLM0360A	3.6	4.0	92.0	44.0	35.0
2XDCLM0370A	3.7	4.0	92.0	44.0	35.0
2XDCLM0380A	3.8	4.0	92.0	44.0	35.0
2XDCLM0390A	3.9	4.0	92.0	44.0	35.0
2XDCLM0400A	4.0	4.0	92.0	44.0	35.0
2XDCLM0410A	4.1	5.0	100.0	45.0	36.0
2XDCLM0420A	4.2	5.0	100.0	45.0	36.0
2XDCLM0430A	4.3	5.0	100.0	45.0	36.0
2XDCLM0440A	4.4	5.0	100.0	45.0	36.0
2XDCLM0450A	4.5	5.0	100.0	45.0	36.0
2XDCLM0460A	4.6	5.0	100.0	45.0	36.0
2XDCLM0470A	4.7	5.0	100.0	45.0	36.0
2XDCLM0480A	4.8	5.0	100.0	45.0	36.0
2XDCLM0490A	4.9	5.0	100.0	45.0	36.0
2XDCLM0500A	5.0	5.0	100.0	45.0	36.0

Twister® XD High Performance Drill - 7⁺xD Series XDCLM

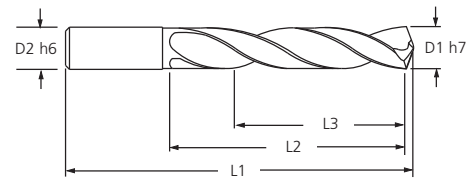
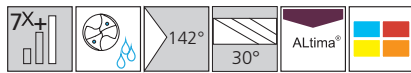

Series 2XDCLM	Drill Dimensions XD CLM				
Tool No.	Ø D1	Ø D2	L1	L2	L3
2XDCLM0510A	5.1	6.0	100.0	51.0	41.0
2XDCLM0520A	5.2	6.0	100.0	51.0	41.0
2XDCLM0530A	5.3	6.0	100.0	51.0	41.0
2XDCLM0540A	5.4	6.0	100.0	51.0	41.0
2XDCLM0550A	5.5	6.0	100.0	51.0	41.0
2XDCLM0570A	5.7	6.0	100.0	51.0	41.0
2XDCLM0580A	5.8	6.0	100.0	51.0	41.0
2XDCLM0590A	5.9	6.0	100.0	51.0	41.0
2XDCLM0600A	6.0	6.0	100.0	51.0	41.0
2XDCLM0610A	6.1	8.0	109.0	60.0	48.0
2XDCLM0620A	6.2	8.0	109.0	60.0	48.0
2XDCLM0630A	6.3	8.0	109.0	60.0	48.0
2XDCLM0640A	6.4	8.0	109.0	60.0	48.0
2XDCLM0650A	6.5	8.0	109.0	60.0	48.0
2XDCLM0660A	6.6	8.0	109.0	60.0	48.0
2XDCLM0670A	6.7	8.0	109.0	60.0	48.0
2XDCLM0680A	6.8	8.0	109.0	60.0	48.0
2XDCLM0690A	6.9	8.0	109.0	60.0	48.0
2XDCLM0700A	7.0	8.0	109.0	60.0	48.0
2XDCLM0710A	7.1	8.0	118.0	70.0	56.0
2XDCLM0720A	7.2	8.0	118.0	70.0	56.0
2XDCLM0730A	7.3	8.0	118.0	70.0	56.0
2XDCLM0740A	7.4	8.0	118.0	70.0	56.0
2XDCLM0750A	7.5	8.0	118.0	70.0	56.0
2XDCLM0760A	7.6	8.0	118.0	70.0	56.0
2XDCLM0770A	7.7	8.0	118.0	70.0	56.0
2XDCLM0780A	7.8	8.0	118.0	70.0	56.0
2XDCLM0790A	7.9	8.0	118.0	70.0	56.0
2XDCLM0800A	8.0	8.0	118.0	70.0	56.0
2XDCLM0810A	8.1	10.0	127.0	80.0	64.0
2XDCLM0820A	8.2	10.0	127.0	80.0	64.0
2XDCLM0830A	8.3	10.0	127.0	80.0	64.0
2XDCLM0840A	8.4	10.0	127.0	80.0	64.0
2XDCLM0850A	8.5	10.0	127.0	80.0	64.0
2XDCLM0860A	8.6	10.0	127.0	80.0	64.0
2XDCLM0870A	8.7	10.0	127.0	80.0	64.0
2XDCLM0880A	8.8	10.0	127.0	80.0	64.0
2XDCLM0890A	8.9	10.0	127.0	80.0	64.0
2XDCLM0900A	9.0	10.0	127.0	80.0	64.0
2XDCLM0910A	9.1	10.0	136.0	85.0	68.0
2XDCLM0920A	9.2	10.0	136.0	85.0	68.0
2XDCLM0925A	9.25	10.0	136.0	85.0	68.0
2XDCLM0930A	9.3	10.0	136.0	85.0	68.0
2XDCLM0940A	9.4	10.0	136.0	85.0	68.0
2XDCLM0950A	9.5	10.0	136.0	85.0	68.0
2XDCLM0960A	9.6	10.0	136.0	85.0	68.0
2XDCLM0970A	9.7	10.0	136.0	85.0	68.0
2XDCLM0980A	9.8	10.0	136.0	85.0	68.0
2XDCLM0990A	9.9	10.0	136.0	85.0	68.0
2XDCLM1000A	10.0	10.0	136.0	85.0	68.0
2XDCLM1010A	10.1	12.0	149.0	93.0	74.0
2XDCLM1020A	10.2	12.0	149.0	93.0	74.0
2XDCLM1030A	10.3	12.0	149.0	93.0	74.0
2XDCLM1040A	10.4	12.0	149.0	93.0	74.0
2XDCLM1050A	10.5	12.0	149.0	93.0	74.0

Twister® XD High Performance Drill - 7⁺xD Series XDCLM

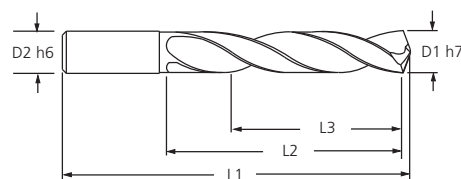

Series 2XDCLM	Drill Dimensions XD CLM				
Tool No.	Ø D1	Ø D2	L1	L2	L3
2XDCLM1060A	10.6	12.0	149.0	93.0	74.0
2XDCLM1070A	10.7	12.0	149.0	93.0	74.0
2XDCLM1080A	10.8	12.0	149.0	93.0	74.0
2XDCLM1090A	10.9	12.0	149.0	93.0	74.0
2XDCLM1100A	11.0	12.0	149.0	93.0	74.0
2XDCLM1110A	11.1	12.0	155.0	102.0	82.0
2XDCLM1120A	11.2	12.0	155.0	102.0	82.0
2XDCLM1130A	11.3	12.0	155.0	102.0	82.0
2XDCLM1140A	11.4	12.0	155.0	102.0	82.0
2XDCLM1150A	11.5	12.0	155.0	102.0	82.0
2XDCLM1160A	11.6	12.0	155.0	102.0	82.0
2XDCLM1170A	11.7	12.0	155.0	102.0	82.0
2XDCLM1180A	11.8	12.0	155.0	102.0	82.0
2XDCLM1190A	11.9	12.0	155.0	102.0	82.0
2XDCLM1200A	12.0	12.0	155.0	102.0	82.0



CYCLONE CXD High Performance Drill - 8xD Series CXDCLM

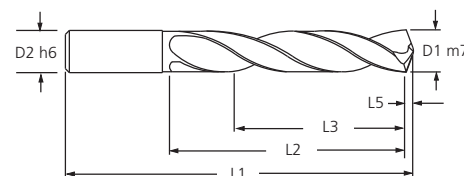

Tool Number	Ø D1	Ø D2	L1	L2 (Max.)	L3	L5
CXDCLM0300AP	3.0	3.0	81.0	33.0	25.0	0.46
CXDCL1200AP	3.05	4.0	92.0	44.0	33.0	0.48
CXDCLM0310AP	3.1	4.0	92.0	44.0	33.0	0.48
CXDCL1250AP	3.18	4.0	92.0	44.0	33.0	0.48
CXDCLM0320AP	3.2	4.0	92.0	44.0	33.0	0.5
CXDCLM0325AP	3.25	4.0	92.0	44.0	33.0	0.51
CXDCL1285AP	3.26	4.0	92.0	44.0	33.0	0.51
CXDCLM0330AP	3.3	4.0	92.0	44.0	33.0	0.51
CXDCLM0340AP	3.4	4.0	92.0	44.0	33.0	0.53
CXDCL1360AP	3.45	4.0	92.0	44.0	33.0	0.53
CXDCLM0350AP	3.5	4.0	92.0	44.0	33.0	0.54
CXDCL1406AP	3.57	4.0	92.0	44.0	33.0	0.56
CXDCLM0360AP	3.6	4.0	92.0	44.0	33.0	0.56
CXDCLM0370AP	3.7	4.0	92.0	44.0	33.0	0.57
CXDCL1496AP	3.8	4.0	92.0	44.0	33.0	0.59
CXDCL1520AP	3.86	4.0	92.0	44.0	33.0	0.6
CXDCLM0390AP	3.9	4.0	92.0	44.0	33.0	0.6
CXDCL1562AP	3.97	4.0	92.0	44.0	33.0	0.61

CYCLONE CXD High Performance Drill - 8xD Series CXDCLM

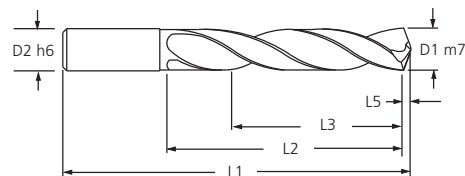

Tool Number	Ø D1	Ø D2	L1	L2 (Max.)	L3	L5
CXDCLM0400AP	4.0	4.0	92.0	44.0	33.0	0.62
CXDCL1590AP	4.04	5.0	100.0	45.0	34.0	0.63
CXDCLM0410AP	4.1	5.0	100.0	45.0	34.0	0.64
CXDCLM0420AP	4.2	5.0	100.0	45.0	34.0	0.65
CXDCLM0430AP	4.3	5.0	100.0	45.0	34.0	0.67
CXDCL1719AP	4.37	5.0	100.0	45.0	34.0	0.68
CXDCLM0440AP	4.4	5.0	100.0	45.0	34.0	0.68
CXDCLM0450AP	4.5	5.0	100.0	45.0	34.0	0.7
CXDCLM0460AP	4.6	5.0	100.0	45.0	34.0	0.71
CXDCLM0465AP	4.65	5.0	100.0	45.0	34.0	0.72
CXDCLM0470AP	4.7	5.0	100.0	45.0	34.0	0.73
CXDCL1875AP	4.76	5.0	100.0	45.0	34.0	0.74
CXDCLM0480AP	4.8	5.0	100.0	45.0	34.0	0.74
CXDCLM0490AP	4.9	5.0	100.0	45.0	34.0	0.76
CXDCLM0500AP	5.0	5.0	100.0	45.0	34.0	0.77
CXDCLM0510AP	5.1	6.0	100.0	57.0	43.0	0.79
CXDCL2031AP	5.16	6.0	100.0	57.0	43.0	0.79
CXDCLM0520AP	5.2	6.0	100.0	57.0	43.0	0.81
CXDCLM0530AP	5.3	6.0	100.0	57.0	43.0	0.82
CXDCLM0540AP	5.4	6.0	100.0	57.0	43.0	0.84
CXDCLM0550AP	5.5	6.0	100.0	57.0	43.0	0.85
CXDCL2187AP	5.56	6.0	100.0	57.0	43.0	0.86
CXDCLM0560AP	5.6	6.0	100.0	57.0	43.0	0.86
CXDCL2210AP	5.61	6.0	100.0	57.0	43.0	0.86
CXDCLM0570AP	5.7	6.0	100.0	57.0	43.0	0.88
CXDCLM0580AP	5.8	6.0	100.0	57.0	43.0	0.9
CXDCLM0590AP	5.9	6.0	100.0	57.0	43.0	0.91
CXDCL2344AP	5.95	6.0	100.0	57.0	43.0	0.91
CXDCLM0600AP	6.0	6.0	100.0	57.0	43.0	0.93
CXDCLM0610AP	6.1	8.0	118.0	76.0	57.0	0.95
CXDCL2420AP	6.15	8.0	118.0	76.0	57.0	0.95
CXDCLM0620AP	6.2	8.0	118.0	76.0	57.0	0.96
CXDCL2460AP	6.25	8.0	118.0	76.0	57.0	0.97
CXDCLM0630AP	6.3	8.0	118.0	76.0	57.0	0.98
CXDCL2500AP	6.35	8.0	118.0	76.0	57.0	0.99
CXDCLM0640AP	6.4	8.0	118.0	76.0	57.0	0.99
CXDCLM0650AP	6.5	8.0	118.0	76.0	57.0	1.01
CXDCL2570AP	6.53	8.0	118.0	76.0	57.0	1.03
CXDCLM0660AP	6.6	8.0	118.0	76.0	57.0	1.03
CXDCL2610AP	6.63	8.0	118.0	76.0	57.0	1.03
CXDCLM0670AP	6.7	8.0	118.0	76.0	57.0	1.04
CXDCL2656AP	6.75	8.0	118.0	76.0	57.0	1.04
CXDCLM0680AP	6.8	8.0	118.0	76.0	57.0	1.05
CXDCLM0690AP	6.9	8.0	118.0	76.0	57.0	1.07
CXDCLM0700AP	7.0	8.0	118.0	76.0	57.0	1.08
CXDCLM0710AP	7.1	8.0	118.0	76.0	57.0	1.1

CYCLONE CXD High Performance Drill - 8xD Series CXDCLM

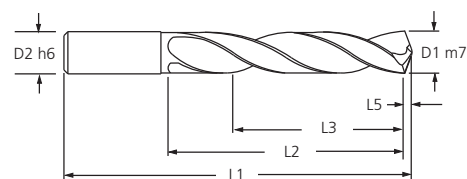
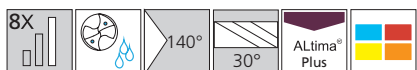

Tool Number	Ø D1	Ø D2	L1	L2 (Max.)	L3	L5
CXDCL2812AP	7.14	8.0	118.0	76.0	57.0	1.12
CXDCLM0720AP	7.2	8.0	118.0	76.0	57.0	1.12
CXDCLM0730AP	7.3	8.0	118.0	76.0	57.0	1.13
CXDCLM0740AP	7.4	8.0	118.0	76.0	57.0	1.15
CXDCLM0750AP	7.5	8.0	118.0	76.0	57.0	1.16
CXDCL2969AP	7.54	8.0	118.0	76.0	57.0	1.17
CXDCLM0760AP	7.6	8.0	118.0	76.0	57.0	1.18
CXDCLM0770AP	7.7	8.0	118.0	76.0	57.0	1.19
CXDCLM0780AP	7.8	8.0	118.0	76.0	57.0	1.21
CXDCLM0790AP	7.9	8.0	118.0	76.0	57.0	1.22
CXDCL3125AP	7.94	8.0	118.0	76.0	57.0	1.22
CXDCLM0800AP	8.0	8.0	118.0	76.0	57.0	1.24
CXDCLM0810AP	8.1	10.0	139.0	87.0	65.0	1.26
CXDCLM0820AP	8.2	10.0	139.0	87.0	65.0	1.27
CXDCLM0830AP	8.3	10.0	139.0	87.0	65.0	1.29
CXDCL3281AP	8.33	10.0	139.0	87.0	65.0	1.3
CXDCLM0840AP	8.4	10.0	139.0	87.0	65.0	1.31
CXDCL3320AP	8.43	10.0	139.0	87.0	65.0	1.31
CXDCLM0850AP	8.5	10.0	139.0	87.0	65.0	1.32
CXDCLM0860AP	8.6	10.0	139.0	87.0	65.0	1.33
CXDCLM0870AP	8.7	10.0	139.0	87.0	65.0	1.35
CXDCL3438AP	8.73	10.0	139.0	87.0	65.0	1.35
CXDCLM0880AP	8.8	10.0	139.0	87.0	65.0	1.36
CXDCLM0890AP	8.9	10.0	139.0	87.0	65.0	1.38
CXDCLM0900AP	9.0	10.0	139.0	87.0	65.0	1.39
CXDCLM0910AP	9.1	10.0	139.0	95.0	71.0	1.41
CXDCL3594AP	9.13	10.0	139.0	95.0	71.0	1.42
CXDCLM0920AP	9.2	10.0	139.0	95.0	71.0	1.43
CXDCLM0925AP	9.25	10.0	139.0	95.0	71.0	1.43
CXDCLM0930AP	9.3	10.0	139.0	95.0	71.0	1.44
CXDCL3680AP	9.35	10.0	139.0	95.0	71.0	1.45
CXDCLM0940AP	9.4	10.0	139.0	95.0	71.0	1.46
CXDCLM0950AP	9.5	10.0	139.0	95.0	71.0	1.47
CXDCL3750AP	9.52	10.0	139.0	95.0	71.0	1.47
CXDCLM0960AP	9.6	10.0	139.0	95.0	71.0	1.49
CXDCLM0970AP	9.7	10.0	139.0	95.0	71.0	1.5
CXDCL3858AP	9.8	10.0	139.0	95.0	71.0	1.52
CXDCLM0990AP	9.9	10.0	139.0	95.0	71.0	1.53
CXDCL3906AP	9.92	10.0	139.0	95.0	71.0	1.55
CXDCLM1000AP	10.0	10.0	139.0	95.0	71.0	1.55
CXDCLM1010AP	10.1	12.0	155.0	106.0	80.0	1.56
CXDCLM1020AP	10.2	12.0	155.0	106.0	80.0	1.58
CXDCLM1030AP	10.3	12.0	155.0	106.0	80.0	1.6
CXDCL4062AP	10.32	12.0	155.0	106.0	80.0	1.6
CXDCLM1040AP	10.4	12.0	155.0	106.0	80.0	1.61
CXDCLM1050AP	10.5	12.0	155.0	106.0	80.0	1.63



CYCLONE CXD High Performance Drill - 8xD Series CXDCLM

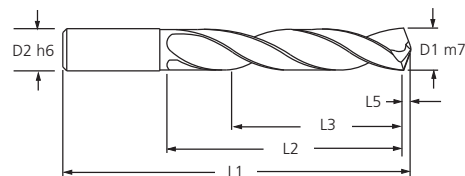

Tool Number	Ø D1	Ø D2	L1	L2 (Max.)	L3	L5
CXDCLM1060AP	10.6	12.0	155.0	106.0	80.0	1.64
CXDCLM1070AP	10.7	12.0	155.0	106.0	80.0	1.66
CXDCL4219AP	10.72	12.0	155.0	106.0	80.0	1.65
CXDCLM1080AP	10.8	12.0	155.0	106.0	80.0	1.67
CXDCLM1090AP	10.9	12.0	155.0	106.0	80.0	1.69
CXDCLM1100AP	11.0	12.0	155.0	106.0	80.0	1.7
CXDCLM1110AP	11.1	12.0	163.0	114.0	86.0	1.72
CXDCL4375AP	11.11	12.0	163.0	114.0	86.0	1.73
CXDCLM1120AP	11.2	12.0	163.0	114.0	86.0	1.74
CXDCLM1130AP	11.3	12.0	163.0	114.0	86.0	1.75
CXDCLM1140AP	11.4	12.0	163.0	114.0	86.0	1.77
CXDCLM1150AP	11.5	12.0	163.0	114.0	86.0	1.78
CXDCLM1160AP	11.6	12.0	163.0	114.0	86.0	1.8
CXDCLM1170AP	11.7	12.0	163.0	114.0	86.0	1.81
CXDCLM1180AP	11.8	12.0	163.0	114.0	86.0	1.83
CXDCLM1190AP	11.9	12.0	163.0	114.0	86.0	1.84
CXDCL4688AP	11.91	12.0	163.0	114.0	86.0	1.85
CXDCLM1200AP	12.0	12.0	163.0	114.0	86.0	1.86
CXDCLM1210AP	12.1	14.0	182.0	133.0	112.0	1.87
CXDCL4844AP	12.3	14.0	182.0	133.0	100.0	1.91
CXDCLM1250AP	12.5	14.0	182.0	133.0	112.0	1.93
CXDCL5000AP	12.7	14.0	182.0	133.0	100.0	1.95
CXDCLM1280AP	12.8	14.0	182.0	133.0	112.0	1.98
CXDCLM1290AP	12.9	14.0	182.0	133.0	112.0	1.99
CXDCLM1300AP	13.0	14.0	182.0	133.0	112.0	2.01
CXDCL5156AP	13.09	14.0	182.0	133.0	112.0	2.03
CXDCL5312AP	13.49	14.0	182.0	133.0	112.0	2.08
CXDCLM1350AP	13.5	14.0	182.0	133.0	112.0	2.09
CXDCLM1370AP	13.7	14.0	182.0	133.0	112.0	2.12
CXDCL5469AP	13.89	14.0	182.0	133.0	112.0	2.16
CXDCLM1400AP	14.0	14.0	182.0	133.0	112.0	2.16
CXDCL5625AP	14.29	16.0	204.0	152.0	128.0	2.21
CXDCLM1450AP	14.5	16.0	204.0	152.0	128.0	2.24
CXDCLM1470AP	14.7	16.0	204.0	152.0	128.0	2.27
CXDCLM1500AP	15.0	16.0	204.0	152.0	128.0	2.32
CXDCL5938AP	15.08	16.0	204.0	152.0	128.0	2.33
CXDCLM1530AP	15.3	16.0	204.0	152.0	128.0	2.36
CXDCLM1550AP	15.5	16.0	204.0	152.0	128.0	2.39
CXDCLM1570AP	15.7	16.0	204.0	152.0	128.0	2.43
CXDCL6250AP	15.87	16.0	204.0	152.0	128.0	2.46
CXDCLM1600AP	16.0	16.0	204.0	152.0	128.0	2.47



CYCLONE CXD High Performance Drill - 15xD Series CXDCEM

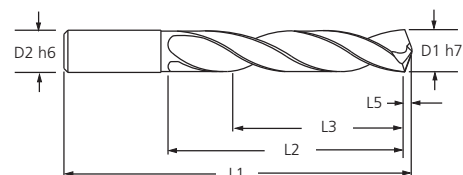
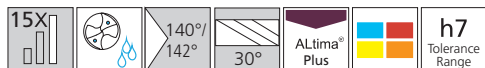

Tool Number	Ø D1	Ø D2	L1	L2 (Max.)	L3	L5
CXDCEM0300AP	3.0	3.0	105.0	56.0	45.0	0.46
CXDCEM0350AP	3.5	4.0	120.0	66.0	53.0	0.54
CXDCEM0400AP	4.0	4.0	120.0	75.0	60.0	0.62
CXDCEM0420AP	4.2	5.0	143.0	79.0	63.0	0.65
CXDCEM0430AP	4.3	5.0	143.0	81.0	65.0	0.67
CXDCEM0440AP	4.4	5.0	143.0	83.0	66.0	0.68
CXDCEM0450AP	4.5	5.0	143.0	84.0	68.0	0.7
CXDCEM0480AP	4.8	5.0	143.0	90.0	72.0	0.74
CXDCEM0490AP	4.9	5.0	143.0	92.0	74.0	0.76
CXDCEM0500AP	5.0	5.0	143.0	94.0	75.0	0.77
CXDCEM0520AP	5.2	6.0	162.0	98.0	78.0	0.81
CXDCEM0540AP	5.4	6.0	162.0	101.0	81.0	0.84
CXDCEM0550AP	5.5	6.0	162.0	103.0	83.0	0.85
CXDCEM0560AP	5.6	6.0	162.0	105.0	84.0	0.86
CXDCEM0580AP	5.8	6.0	162.0	109.0	87.0	0.9
CXDCEM0600AP	6.0	6.0	162.0	113.0	90.0	0.93
CXDCEM0610AP	6.1	8.0	200.0	114.0	92.0	0.95
CXDCEM0620AP	6.2	8.0	200.0	116.0	93.0	0.96
CXDCEM0630AP	6.3	8.0	200.0	118.0	95.0	0.98
CXDCEM0650AP	6.5	8.0	200.0	122.0	98.0	1.01
CXDCEM0680AP	6.8	8.0	200.0	128.0	102.0	1.05
CXDCEM0700AP	7.0	8.0	200.0	131.0	105.0	1.08
CXDCEM0740AP	7.4	8.0	200.0	139.0	111.0	1.15
CXDCEM0750AP	7.5	8.0	200.0	141.0	113.0	1.16
CXDCEM0760AP	7.6	8.0	200.0	143.0	114.0	1.18
CXDCEM0780AP	7.8	8.0	200.0	146.0	117.0	1.21
CXDCEM0800AP	8.0	8.0	200.0	150.0	120.0	1.24
CXDCEM0820AP	8.2	10.0	240.0	154.0	123.0	1.27
CXDCEM0830AP	8.3	10.0	240.0	156.0	125.0	1.29
CXDCEM0840AP	8.4	10.0	240.0	158.0	126.0	1.3
CXDCEM0850AP	8.5	10.0	240.0	159.0	128.0	1.32
CXDCEM0870AP	8.7	10.0	240.0	163.0	131.0	1.35
CXDCEM0900AP	9.0	10.0	240.0	169.0	135.0	1.39
CXDCEM0940AP	9.4	10.0	240.0	176.0	141.0	1.46
CXDCEM0980AP	9.8	10.0	240.0	184.0	147.0	1.52
CXDCEM1000AP	10.0	10.0	240.0	188.0	150.0	1.55
CXDCEM1020AP	10.2	12.0	283.0	191.0	153.0	1.58
CXDCEM1030AP	10.3	12.0	283.0	193.0	155.0	1.6
CXDCEM1050AP	10.5	12.0	283.0	197.0	158.0	1.63
CXDCEM1080AP	10.8	12.0	283.0	203.0	162.0	1.67
CXDCEM1100AP	11.0	12.0	283.0	206.0	165.0	1.7
CXDCEM1150AP	11.5	12.0	283.0	216.0	173.0	1.78
CXDCEM1180AP	11.8	12.0	283.0	221.0	177.0	1.83
CXDCEM1200AP	12.0	12.0	283.0	225.0	180.0	1.86



Twister® XD High Performance Micro Drill - 10xD Series MDCLM

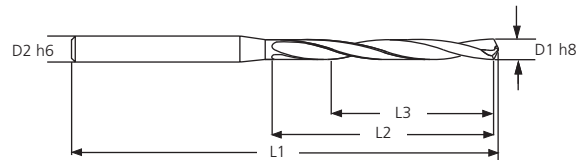
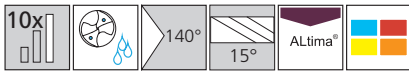

Series 2MDCLM	Drill Dimensions MD CLM				
Tool No.	Ø D1	Ø D2	L1	L2	L3
2MDCLM0200A	2.0	3.0	68.0	24.0	18.0
2MDCLM0205A	2.05	3.0	74.0	28.0	21.0
2MDCLM0210A	2.1	3.0	74.0	28.0	21.0
2MDCLM0215A	2.15	3.0	74.0	28.0	21.0
2MDCLM0220A	2.2	3.0	74.0	28.0	21.0
2MDCLM0225A	2.25	3.0	74.0	28.0	21.0
2MDCLM0230A	2.3	3.0	74.0	28.0	21.0
2MDCLM0235A	2.35	3.0	74.0	28.0	21.0
2MDCLM0240A	2.4	3.0	74.0	28.0	21.0
2MDCLM0245A	2.45	3.0	74.0	28.0	21.0
2MDCLM0250A	2.5	3.0	74.0	28.0	21.0
2MDCLM0255A	2.55	3.0	81.0	34.0	25.5
2MDCLM0260A	2.6	3.0	81.0	34.0	25.5
2MDCLM0265A	2.65	3.0	81.0	34.0	25.5
2MDCLM0270A	2.7	3.0	81.0	34.0	25.5
2MDCLM0275A	2.75	3.0	81.0	34.0	25.5
2MDCLM0280A	2.8	3.0	81.0	34.0	25.5
2MDCLM0285A	2.85	3.0	81.0	34.0	25.5
2MDCLM0290A	2.9	3.0	81.0	34.0	25.5
2MDCLM0295A	2.95	3.0	81.0	34.0	25.5



Tolerances

Drill Dia. (h8)	Tolerance
2.0 - 2.95	+0/-0.014

Shank Dia. (h6)	Tolerance
3.0	+0/-0.006

Machine Requirements

High Pressure Pump System (1000 psi)
Coolant filtration of 10 microns or better
Machine runout of .0004" (.01mm) Max.

M.A. Ford® does not recommend full retraction of the body of the drill from the hole during the peck cycle. It is recommended to leave the drill point within the hole.

Estimated Peck Depths

For hole depths up to 6x diameter No pecks
For hole depths up to 10x diameter 0-2 pecks
For hole depths up to 15x diameter 2-4 pecks

For hole depths deeper than 4x the diameter, M.A. Ford® recommends using a "soft start" program that drills to .5x diameter deep at 2/3 of the speed and feed.

Twister® High Performance Micro Drill - 12xD Series MXDCL

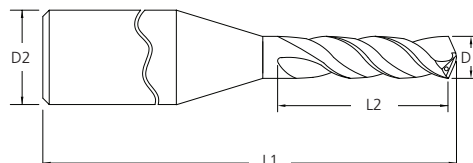
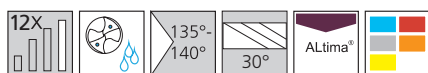

ALtima®		Drill Dimensions			
Tool No.	EDP	Ø D1	Ø D2	L1	L2
MXDCLM0100A	04834	1.0	3.0	60.0	16.0
MXDCLM0105A	04835	1.05	3.0	60.0	17.0
MXDCLM0110A	04836	1.1	3.0	60.0	18.0
MXDCLM0115A	04837	1.15	3.0	60.0	19.0
MXDCLM0120A	04838	1.2	3.0	65.0	20.0
MXDCLM0125A	04839	1.25	3.0	65.0	20.0
MXDCLM0130A	04840	1.3	3.0	65.0	21.0
MXDCLM0135A	04841	1.35	3.0	65.0	22.0
MXDCLM0140A	04842	1.4	3.0	65.0	23.0
MXDCLM0145A	04843	1.45	3.0	65.0	24.0
MXDCLM0150A	04844	1.5	3.0	65.0	24.0
MXDCLM0155A	04845	1.55	3.0	65.0	25.0
MXDCLM0160A	04846	1.6	3.0	70.0	26.0
MXDCLM0165A	04847	1.65	3.0	70.0	27.0
MXDCLM0170A	04848	1.7	3.0	70.0	28.0
MXDCLM0175A	04849	1.75	3.0	70.0	28.0
MXDCLM0180A	04850	1.8	3.0	70.0	29.0
MXDCLM0185A	04851	1.85	3.0	70.0	30.0
MXDCLM0190A	04852	1.9	3.0	75.0	31.0
MXDCLM0195A	04853	1.95	3.0	75.0	32.0

ALtima®		Drill Dimensions			
Tool No.	EDP	Ø D1	Ø D2	L1	L2
MXDCLM0200A	04854	2.00	3.0	75.0	32.0
MXDCLM0205A	04855	2.05	3.0	75.0	33.0
MXDCLM0210A	04856	2.10	3.0	75.0	34.0
MXDCLM0215A	04857	2.15	3.0	75.0	35.0
MXDCLM0220A	04858	2.20	3.0	75.0	36.0
MXDCLM0225A	04859	2.25	3.0	75.0	36.0
MXDCLM0230A	04860	2.30	3.0	75.0	37.0
MXDCLM0235A	04861	2.35	3.0	75.0	38.0
MXDCLM0240A	04862	2.40	3.0	75.0	39.0
MXDCLM0245A	04863	2.45	3.0	75.0	40.0
MXDCLM0250A	04864	2.50	3.0	75.0	40.0
MXDCLM0255A	04865	2.55	3.0	80.0	41.0
MXDCLM0260A	04866	2.60	3.0	80.0	42.0
MXDCLM0265A	04867	2.65	3.0	80.0	43.0
MXDCLM0270A	04868	2.70	3.0	80.0	44.0
MXDCLM0275A	04869	2.75	3.0	80.0	44.0
MXDCLM0280A	04870	2.80	3.0	80.0	45.0
MXDCLM0285A	04871	2.85	3.0	80.0	46.0
MXDCLM0290A	04872	2.90	3.0	85.0	47.0
MXDCLM0295A	04873	2.95	3.0	85.0	48.0

Metric (mm)	
D1	Tolerance (h7)
1.00 - 2.95	+0/-0.010

Metric (mm)	
D2	Tolerance (h6)
3.0	+0/-0.006



Twister[®] XD High Performance Drill - 12⁺xD Series XDCEM

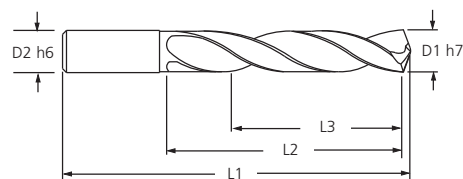

Series 2XDCEM	Drill Dimensions						
Tool No.	Ø D1	Ø D2	L1	L2	L3	L2 / D1 (D1 x Ø)	L3 / D1 (D1 x Ø)
2XDCEM0400A	4.0	4.0	163.0	100.0	80.0	25.0	20.0
2XDCEM0500A	5.0	5.0	163.0	105.0	84.0	21.0	17.0
2XDCEM0520A	5.2	6.0	163.0	110.0	88.0	21.0	17.0
2XDCEM0540A	5.4	6.0	163.0	110.0	88.0	20.0	16.0
2XDCEM0560A	5.6	6.0	163.0	110.0	88.0	20.0	16.0
2XDCEM0580A	5.8	6.0	163.0	110.0	88.0	19.0	15.0
2XDCEM0600A	6.0	6.0	163.0	110.0	88.0	18.0	15.0
2XDCEM0620A	6.2	8.0	163.0	110.0	88.0	18.0	14.0
2XDCEM0630A	6.3	8.0	163.0	110.0	88.0	17.0	14.0
2XDCEM0635A	6.35	8.0	163.0	110.0	88.0	17.0	14.0
2XDCEM0680A	6.8	8.0	163.0	110.0	88.0	16.0	13.0
2XDCEM0700A	7.0	8.0	163.0	110.0	88.0	16.0	13.0
2XDCEM0760A	7.6	8.0	163.0	120.0	96.0	16.0	13.0
2XDCEM0780A	7.8	8.0	163.0	120.0	96.0	15.0	12.0
2XDCEM0794A	7.94	8.0	163.0	120.0	96.0	15.0	12.0
2XDCEM0800A	8.0	8.0	163.0	120.0	96.0	15.0	12.0
2XDCEM0820A	8.2	10.0	180.0	135.0	108.0	16.0	13.0
2XDCEM0850A	8.5	10.0	180.0	135.0	108.0	16.0	13.0
2XDCEM0870A	8.7	10.0	180.0	135.0	108.0	16.0	12.0
2XDCEM0900A	9.0	10.0	180.0	135.0	108.0	15.0	12.0
2XDCEM0940A	9.4	10.0	195.0	150.0	120.0	16.0	13.0
2XDCEM0953A	9.53	10.0	195.0	150.0	120.0	16.0	13.0
2XDCEM0980A	9.8	10.0	195.0	150.0	120.0	15.0	12.0
2XDCEM1000A	10.0	10.0	195.0	150.0	120.0	15.0	12.0
2XDCEM1030A	10.3	12.0	210.0	160.0	128.0	16.0	12.0
2XDCEM1050A	10.5	12.0	210.0	160.0	128.0	15.0	12.0
2XDCEM1080A	10.8	12.0	210.0	160.0	128.0	15.0	12.0
2XDCEM1100A	11.0	12.0	210.0	160.0	128.0	15.0	12.0
2XDCEM1111A	11.11	12.0	210.0	160.0	128.0	14.0	12.0
2XDCEM1150A	11.5	12.0	210.0	160.0	128.0	14.0	12.0
2XDCEM1180A	11.8	12.0	210.0	160.0	128.0	14.0	12.0
2XDCEM1200A	12.0	12.0	210.0	160.0	128.0	13.0	12.0
2XDCEM1270A	12.7	14.0	230.0	180.0	144.0	14.0	12.0



CYCLONE CDA High Performance Aluminium Drill - 5xD Series CDACRM

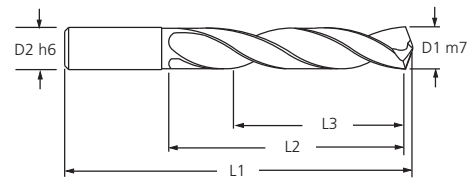
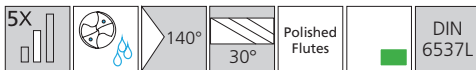

Tool Number	Ø D1	Ø D2	L1	L2 (max)	L3 (Ref)
CDACRM0300	3.0	6.0	66.0	28.0	23.0
CDACRM0310	3.1	6.0	66.0	28.0	23.0
CDACRM0320	3.2	6.0	66.0	28.0	23.0
CDACRM0330	3.3	6.0	66.0	28.0	23.0
CDACRM0340	3.4	6.0	66.0	28.0	23.0
CDACRM0350	3.5	6.0	66.0	28.0	23.0
CDACRM0360	3.6	6.0	66.0	28.0	23.0
CDACRM0370	3.7	6.0	66.0	28.0	23.0
CDACRM0380	3.8	6.0	74.0	36.0	29.0
CDACRM0390	3.9	6.0	74.0	36.0	29.0
CDACRM0400	4.0	6.0	74.0	36.0	29.0
CDACRM0410	4.1	6.0	74.0	36.0	29.0
CDACRM0420	4.2	6.0	74.0	36.0	29.0
CDACRM0430	4.3	6.0	74.0	36.0	29.0
CDACRM0440	4.4	6.0	74.0	36.0	29.0
CDACRM0450	4.5	6.0	74.0	36.0	29.0
CDACRM0460	4.6	6.0	74.0	36.0	29.0
CDACRM0470	4.7	6.0	74.0	36.0	29.0
CDACRM0480	4.8	6.0	82.0	44.0	35.0
CDACRM0490	4.9	6.0	82.0	44.0	35.0
CDACRM0500	5.0	6.0	82.0	44.0	35.0
CDACRM0510	5.1	6.0	82.0	44.0	35.0
CDACRM0520	5.2	6.0	82.0	44.0	35.0
CDACRM0530	5.3	6.0	82.0	44.0	35.0
CDACRM0540	5.4	6.0	82.0	44.0	35.0
CDACRM0550	5.5	6.0	82.0	44.0	35.0
CDACRM0560	5.6	6.0	82.0	44.0	35.0
CDACRM0570	5.7	6.0	82.0	44.0	35.0
CDACRM0580	5.8	6.0	82.0	44.0	35.0
CDACRM0590	5.9	6.0	82.0	44.0	35.0
CDACRM0600	6.0	6.0	82.0	44.0	35.0
CDACRM0610	6.1	8.0	91.0	53.0	43.0
CDACRM0620	6.2	8.0	91.0	53.0	43.0
CDACRM0630	6.3	8.0	91.0	53.0	43.0
CDACRM0640	6.4	8.0	91.0	53.0	43.0
CDACRM0650	6.5	8.0	91.0	53.0	43.0
CDACRM0660	6.6	8.0	91.0	53.0	43.0
CDACRM0670	6.7	8.0	91.0	53.0	43.0
CDACRM0680	6.8	8.0	91.0	53.0	43.0
CDACRM0690	6.9	8.0	91.0	53.0	43.0
CDACRM0700	7.0	8.0	91.0	53.0	43.0
CDACRM0710	7.1	8.0	91.0	53.0	43.0
CDACRM0720	7.2	8.0	91.0	53.0	43.0
CDACRM0730	7.3	8.0	91.0	53.0	43.0
CDACRM0740	7.4	8.0	91.0	53.0	43.0
CDACRM0750	7.5	8.0	91.0	53.0	43.0



CYCLONE CDA High Performance Aluminium Drill - 5xD Series CDACRM

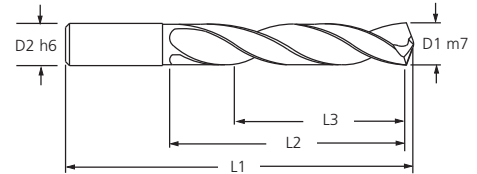
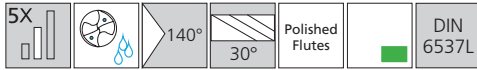

Tool Number	Ø D1	Ø D2	L1	L2 (max)	L3 (Ref)
CDACRM0760	7.6	8.0	91.0	53.0	43.0
CDACRM0770	7.7	8.0	91.0	53.0	43.0
CDACRM0780	7.8	8.0	91.0	53.0	43.0
CDACRM0790	7.9	8.0	91.0	53.0	43.0
CDACRM0800	8.0	8.0	91.0	53.0	43.0
CDACRM0810	8.1	10.0	103.0	61.0	49.0
CDACRM0820	8.2	10.0	103.0	61.0	49.0
CDACRM0830	8.3	10.0	103.0	61.0	49.0
CDACRM0840	8.4	10.0	103.0	61.0	49.0
CDACRM0850	8.5	10.0	103.0	61.0	49.0
CDACRM0860	8.6	10.0	103.0	61.0	49.0
CDACRM0870	8.7	10.0	103.0	61.0	49.0
CDACRM0880	8.8	10.0	103.0	61.0	49.0
CDACRM0890	8.9	10.0	103.0	61.0	49.0
CDACRM0900	9.0	10.0	103.0	61.0	49.0
CDACRM0910	9.1	10.0	103.0	61.0	49.0
CDACRM0920	9.2	10.0	103.0	61.0	49.0
CDACRM0930	9.3	10.0	103.0	61.0	49.0
CDACRM0940	9.4	10.0	103.0	61.0	49.0
CDACRM0950	9.5	10.0	103.0	61.0	49.0
CDACRM0960	9.6	10.0	103.0	61.0	49.0
CDACRM0970	9.7	10.0	103.0	61.0	49.0
CDACRM0980	9.8	10.0	103.0	61.0	49.0
CDACRM0990	9.9	10.0	103.0	61.0	49.0
CDACRM1000	10.0	10.0	103.0	61.0	49.0
CDACRM1010	10.0	12.0	118.0	71.0	56.0
CDACRM1020	10.2	12.0	118.0	71.0	56.0
CDACRM1030	10.3	12.0	118.0	71.0	56.0
CDACRM1040	10.4	12.0	118.0	71.0	56.0
CDACRM1050	10.5	12.0	118.0	71.0	56.0
CDACRM1060	10.6	12.0	118.0	71.0	56.0
CDACRM1070	10.7	12.0	118.0	71.0	56.0
CDACRM1080	10.8	12.0	118.0	71.0	56.0
CDACRM1090	10.9	12.0	118.0	71.0	56.0
CDACRM1100	11.0	12.0	118.0	71.0	56.0
CDACRM1110	11.1	12.0	118.0	71.0	56.0
CDACRM1120	11.2	12.0	118.0	71.0	56.0
CDACRM1130	11.3	12.0	118.0	71.0	56.0
CDACRM1140	11.4	12.0	118.0	71.0	56.0
CDACRM1150	11.5	12.0	118.0	71.0	56.0
CDACRM1160	11.6	12.0	118.0	71.0	56.0
CDACRM1170	11.7	12.0	118.0	71.0	56.0
CDACRM1180	11.8	12.0	118.0	71.0	56.0
CDACRM1190	11.9	12.0	118.0	71.0	56.0
CDACRM1200	12.0	12.0	118.0	71.0	56.0
CDACRM1250	12.5	14.0	124.0	77.0	60.0



Twister® Micro-Tuff™ Drill

Series 305M 305AM Recommended cutting data

Conditions de coupe recommandées | Empfohlene Schnittdaten | Dati di taglio raccomandati | Zalecane dane o cięciu (Zalacane parametry skrawania)

Recommended Speeds By Material Group		Vc (m/min)		
Material Groups	Material Type	305M	305AM	
		Uncoated	Altima® Micro Coated	
Steels	P	Low Carbon	30 - 40	40 - 50
		Alloy Steel (≤ 35 Rc)	20 - 30	35 - 45
		Alloy Steel (36-45 Rc)	20 - 30	35 - 45
Stainless Steels	M	Free Machining	30 - 40	40 - 50
		Austenitic	20 - 30	35 - 45
		Ferritic/Martensitic	20 - 30	30 - 40
		PH Stainless	10 - 20	15 - 25
Cast Irons	K	Grey Cast Iron	30 - 40	40 - 50
		Ductile Cast Iron	30 - 40	40 - 50
Special Alloys	S	Titanium Alloys (Ti6AL4v)	10 - 20	15 - 25
		High Temp Alloys (Inconel, Nimonic, Hastelloy)	10 - 20	15 - 25
Hardened Steels	H	45 - 55 Rc Steel	5 - 15	10 - 20
Non-Ferrous	N	Aluminium Alloys (< 10% Si)	50 - 60	-
		Plastics		

RPM Formula For Metric Drills Only - $RPM = (Vc \times 318.0) \div \text{Drill } \varnothing D^1$

Series 305M 305AM Recommended cutting data

Conditions de coupe recommandées | Empfohlene Schnittdaten | Dati di taglio raccomandati | Zalecane dane o cięciu (Zalacane parametry skrawania)

Recommended Feedrates By Material Group		Drill Diameter (mm)					
Material Groups	Material Type	0.5	1.0	1.5	2.0	3.0	
		Feed (mm/rev)					
Steels	P	Low Carbon					
		Alloy Steel (≤ 35 Rc)	0.01	0.02	0.04	0.06	0.075
		Alloy Steel (36-45 Rc)					
Stainless Steels	M	Free Machining					
		Austenitic	0.01	0.02	0.04	0.06	0.075
		Ferritic/Martensitic					
		PH Stainless	0.005	0.01	0.02	0.03	0.035
Cast Irons	K	Grey Cast Iron	0.01	0.02	0.04	0.06	0.075
		Ductile Cast Iron					
Special Alloys	S	Titanium Alloys (Ti6AL4v)	0.01	0.02	0.04	0.06	0.075
		High Temp Alloys (Inconel, Nimonic, Hastelloy)	0.005	0.01	0.02	0.025	0.035
Hardened Steels	H	45 - 55 Rc Steel	0.005	0.01	0.02	0.025	0.035
Non-Ferrous	N	Aluminium Alloys (< 10% Si)	0.015	0.025	0.05	0.075	0.10
		Plastics					

Recommended Pecking Depths By Drill Diameter* (Ø D¹)

Diameter Ø D ¹	Pecking Depth
0.50	0.5 x Ø D ¹
1.00	1 x Ø D ¹
1.50	1.5 x Ø D ¹
2.00	2 x Ø D ¹
3.00	3 x Ø D ¹

* Pecking depths can vary by material type

Feedrate Formula For Metric Drills - $\text{Feed} = RPM \times \text{mm/rev}$

Twister® XD High Performance Drills

Series MXDSR Recommended cutting data

Conditions de coupe recommandées | Empfohlene Schnittdaten | Dati di taglio raccomandati | Zalecane dane o cięciu (Zalecane parametry skrawania)

Material Groups	ISO	Hardness	vc - m/min	Drill Diameter (mm)					
				0.5	1.0	1.5	2.0	2.5	2.95
				Feed (mm/rev)					
Free Machining & Low Carbon Steels	P	up to 28 Rc	45	.010	.020	.030	.040	.060	.075
Medium Carbon & High Carbon Steels, Alloy Steels & Easy to Machine Tool Steels	P	28 to 38 Rc	40	.010	.020	.030	.040	.060	.075
Tool Steels & Die Steel	P	28 to 44 Rc	40	.010	.020	.030	.040	.060	.075
Free Machining Stainless	M	up to 28 Rc	45	.010	.020	.030	.040	.060	.075
Stainless Steel - Austenitic 304 / 316	M	up to 28 Rc	40	.010	.020	.030	.040	.060	.075
Stainless Steel - Ferritic / Martensitic	M	up to 28 Rc	35	.010	.020	.030	.040	.060	.075
Stainless Steel - Moderately Difficult	M	over 28 Rc	20	.010	.020	.030	.040	.060	.075
Cast Iron - Gray CG	K	up to 240 HB	45	.010	.020	.030	.040	.060	.075
Cast Iron - Ductile & Malleable CGI	K	over 240 HB	45	.010	.020	.030	.040	.060	.075
Titanium	S	up to 40 Rc	20	.010	.020	.030	.040	.060	.075
High Temp Alloys Inconel / Hastelloy / Waspeloy / Nickel Based Alloys-Monel	S		20	.005	.010	.015	.020	.025	.075
Hardened Steels	H	55 Rc	15	.005	.010	.015	.020	.025	.035
Aluminum (<10% Si)	N		55	.015	.025	.040	.050	.075	.100
Plastics	N			.015	.025	.040	.050	.075	.100

Twister® XD Spot Drill

Series 200S Spot Drill Recommended Feed

Avance recommandée | Empfohlener Vorschub | Avanzamento consigliato | Zalecany Posuw

Materials	Vc (m/min)	Drill Diameter (mm)				
		6	8	10	12	16
		Feed (mm/rev)				
Low Carbon Steel <0.3%C	100	0.076	0.1	0.13	0.16	0.16
Medium Carbon Steel	80	0.076	0.1	0.13	0.16	0.16
Alloy Steel ≤ 35hrc	70	0.076	0.1	0.13	0.16	0.16
Alloy Steel 36- 45hrc	45	0.076	0.1	0.13	0.16	0.16
Alloy Steel 45-50hrc	40	0.076	0.1	0.13	0.16	0.16
Grey Cast Iron	110	0.076	0.1	0.13	0.16	0.16
Ductile Cast Iron	80	0.076	0.1	0.13	0.16	0.16
Austenitic Stainless	45	0.076	0.1	0.13	0.16	0.16
Ph Stainless	30	0.076	0.1	0.13	0.16	0.16
High Temp Alloys	20	0.076	0.1	0.13	0.16	0.16
Titanium Alloys	55	0.076	0.1	0.13	0.16	0.16

RPM Formula For Metric Drills Only - $RPM = (Vc \times 318.0) \div \text{Drill } \varnothing D^1$

Feedrate Formula For Metric Drills - $\text{Feed} = RPM \times \text{mm/rev}$

Twister® XD High Performance Drills

Recommended Speed - XD/MD Drills

Vitesse Recommandée | Empfohlene Drehzahl | Velocità di taglio raccomandata | Zalecane prędkości

Materials	Vc (m/min)					
	2XDSSM 3 X D SOLID	2XDSRM 5 X D SOLID	2XDSCM 3 X D COOLANT	2XDCRM 5 X D COOLANT	2XDCLM 7 X D COOLANT	2MDCLM 10 X D COOLANT
Low Carbon Steel <0.3%C	80-120	75-100	150-200	150-200	130-145	80-90
Medium Carbon Steel	75-100	65-90	125-175	125-175	100-130	80-90
Alloy Steel ≤ 35hrc	60-75	50-70	75-105	75-105	70-90	80-90
Alloy Steel 36- 45hrc	45-60	40-55	45-70	45-70	40-55	60-80
Alloy Steel 45-50hrc	30-35	25-30	35-50	35-50	35-45	40-60
Grey Cast Iron	100-120	80-100	150-200	150-200	110-140	80-90
Ductile Cast Iron	75-90	65-80	135-150	135-150	130-145	60-80
Austenitic Stainless	30-45	25-40	80-150	80-150	45-65	60-70
Ph Stainless	20-35	15-30	50-80	50-80	30-45	40-50
High Temp Alloys	15-30	10-25	15-35	15-35	20-30	20-25
Titanium Alloys	35-45	30-40	55-70	55-70	50-65	40-50

RPM Formula For Metric Drills Only - $RPM = (Vc \times 318.0) \div \text{Drill } \varnothing D^1$

Series XD Drill - Recommended Feed 0.5 - 6mm diameter

Avance recommandée pour un diamètre de 0.5 – 6mm | Empfohlener Vorschub 0,5 – 6 mm Durchmesser

Avanzamento raccomandato per diametri 0,5 - 6mm | Zalecany posuw dla średnic 0.5-6mm

Materials	Feed (mm/rev)					
	0.5	1.5	3	4	5	6
Low Carbon Steel <0.3%C	0.025-0.05	0.05-0.075	0.075-0.12	0.1-0.15	0.12-0.18	0.14-0.2
Medium Carbon Steel	0.025-0.05	0.05-0.075	0.075-0.12	0.1-0.15	0.12-0.18	0.14-0.2
Alloy Steel ≤ 35hrc	0.025-0.05	0.05-0.075	0.075-0.12	0.1-0.15	0.12-0.18	0.14-0.2
Alloy Steel 36- 45hrc	0.01-0.025	0.025-0.04	0.05-0.11	0.08-0.13	0.12-0.18	0.14-0.2
Alloy Steel 45-50hrc	0.01-0.02	0.02-0.03	0.035-0.075	0.06-0.1	0.08-0.12	0.09-0.15
Grey Cast Iron	0.025-0.05	0.05-0.075	0.075-0.12	0.1-0.15	0.12-0.18	0.14-0.2
Ductile Cast Iron	0.025-0.05	0.05-0.075	0.075-0.12	0.1-0.15	0.12-0.18	0.14-0.2
Austenitic Stainless	0.025-0.05	0.05-0.075	0.075-0.12	0.1-0.15	0.12-0.18	0.14-0.2
Ph Stainless	0.01-0.03	0.025-0.05	0.05-0.085	0.06-0.09	0.07-0.11	0.08-0.12
High Temp Alloys	0.01-0.03	0.025-0.05	0.035-0.085	0.04-0.09	0.05-0.10	0.06-0.11
Titanium Alloys	0.01-0.03	0.025-0.05	0.075-0.12	0.1-0.15	0.12-0.18	0.14-0.2

Feedrate Formula For Metric Drills - $\text{Feed} = \text{RPM} \times \text{mm/rev}$

Twister® XD High Performance Drills

Series 2MDCL Micro Coolant Drills - Recommended Feed

Conditions de coupe recommandées | Empfohlene Schnittdaten | Dati di taglio raccomandati | Zalecane dane o cięciu (Zalacane parametry skrawania)

Materials	Feed (mm/rev)		
	Diameter		
	2	2.5	2.9
Low Carbon Steel <0.3%C	0.046	0.051	0.056
Medium Carbon Steel	0.046	0.051	0.056
Alloy Steel ≤ 35hrc	0.046	0.051	0.056
Alloy Steel 36- 45hrc	0.046	0.046	0.051
Alloy Steel 45-50hrc	0.025	0.033	0.046
Grey Cast Iron	0.046	0.051	0.056
Ductile Cast Iron	0.046	0.051	0.056
Austenitic Stainless	0.033	0.038	0.043
Ph Stainless	0.025	0.027	0.038
High Temp Alloys	0.025	0.027	0.036
Titanium Alloys	0.025	0.027	0.036

Feedrate Formula For Metric Drills - Feed = RPM x mm/rev

Twister® XD High Performance Drills

Series XD Drill - Recommended Feed 8 - 20mm Diameter

 Avance recommandée 8 - 20mm de diamètre | Produktreihe XD-Bohrer – empfohlener Vorschub 8 – 20 mm Durchmesser
 Avanzamento raccomandato per diametri 8 - 20mm | Zalecany posuw dla średnic 8 - 20mm

Materials	Feed (mm/rev)						
	8	10	12	14	16	18	20
Low Carbon Steel <0.3%C	0.16-0.24	0.18-0.27	0.2-0.3	0.22-0.35	0.25-0.36	0.28-0.38	0.3-0.4
Medium Carbon Steel	0.16-0.24	0.18-0.27	0.2-0.3	0.22-0.35	0.25-0.36	0.28-0.38	0.3-0.4
Alloy Steel ≤ 35hrc	0.16-0.24	0.18-0.27	0.2-0.3	0.22-0.35	0.25-0.36	0.28-0.38	0.3-0.4
Alloy Steel 36- 45hrc	0.16-0.24	0.18-0.27	0.2-0.3	0.22-0.35	0.25-0.36	0.28-0.38	0.3-0.4
Alloy Steel 45-50hrc	0.12-0.2	0.13-0.23	0.13-0.23	0.15-0.26	0.16-0.26	0.18-0.28	0.2-0.3
Grey Cast Iron	0.16-0.24	0.18-0.27	0.2-0.3	0.22-0.35	0.25-0.36	0.28-0.38	0.3-0.4
Ductile Cast Iron	0.16-0.24	0.18-0.27	0.2-0.3	0.22-0.35	0.25-0.36	0.28-0.38	0.3-0.4
Austenitic Stainless	0.16-0.24	0.18-0.27	0.2-0.3	0.22-0.35	0.25-0.36	0.28-0.38	0.3-0.4
Ph Stainless	0.1-0.15	0.13-0.23	0.18-0.25	0.2-0.27	0.22-0.3	0.25-0.33	0.28-0.35
High Temp Alloys	0.08-0.13	0.1-0.15	0.12-0.17	0.14-0.19	0.16-0.21	0.18-0.25	0.23-0.28
Titanium Alloys	0.16-0.24	0.18-0.27	0.2-0.3	0.22-0.35	0.25-0.36	0.28-0.38	0.3-0.4

Feedrate Formula For Metric Drills - Feed = RPM x mm/rev

Twister® Series MPDCS/MXDRC/MXDCL

Recommended cutting data : Conditions de coupe recommandées : Empfohlene Schnittdaten : Dati di taglio Raccomandati : Zalecane Parametry

Workpiece Material Group	ISO	Hardness	Tool Series	TYPE	DEPTH	vc- m/min.	Drill Diameter (mm)					
							0.5	1.0	1.5	2.0	2.5	2.95
							f - mm/Rev					
Free Machining & Low Carbon Steels, 1006, 1008, 1015, 1018, 1020, 1022, 1025, 1117, 1140, 1141, 11L08, 11L14, 1213, 12L13, 12L14, 1215, 1330	P	up to 28 Rc	MXDSR		5	45	0.013	0.025	0.038	0.050	0.063	0.076
			MPDCS		2	90	-	0.025	0.038	0.050	0.063	0.076
			MXDRC		5							
			MXDCL		12							
Medium Carbon & High Carbon Steels, Alloy Steels & Easy to Machine Tool Steels 1030, 1035, 1040, 1045, 1050, 1052, 1055, 1060, 1085, 1095, 1541, 1551, 9255, 2515, 3135, 3415, 4130, 4137, 4140, 4150, 4320, 4340, 4520, 5015, 5115, 5120, 5132, 5140, 5155, 6150, 8620, 9262, 9840, 52100, O1, O2, O6, S2, W1 to W310	P	28 to 38 Rc	MXDSR		5	40	0.013	0.025	0.038	0.050	0.063	0.076
			MPDCS		2	90	-	0.025	0.038	0.050	0.063	0.076
			MXDRC		5							
			MXDCL		12							
Tool Steels & Die Steels O7, M1, M2, M3, M4, M7, T1, T2, T4, T5, T8, T15, A2, A3, A6, A7, H10, H11, H12, H13, H19, H21, L3, L6, L7, P2, P20, S1, S5, S7, S2100, A128, D2, D3, D4, D5, D7	P	28 to 44 Rc	MXDSR		5	35	0.013	0.025	0.038	0.050	0.063	0.076
			MPDCS		2	75	-	0.025	0.038	0.050	0.063	0.076
			MXDRC		5							
			MXDCL		12							
Stainless Steel - Easy to Machine 430F, 301, 303, 410, 416 Annealed, 420F, 430	M	up to 28 Rc	MXDSR		5	40	0.013	0.025	0.038	0.050	0.063	0.076
			MPDCS		2	90	-	0.025	0.038	0.050	0.063	0.076
			MXDRC		5							
			MXDCL		12							
Stainless Steel - Moderately Difficult 301, 302, 303 High Tensile, 304, 304L, 305, 420, 15-5PH, 17-4PH, 17-7PH	M	up to 28 Rc	MXDSR		5	38	0.013	0.025	0.038	0.050	0.063	0.076
			MPDCS		2	70	-	0.025	0.038	0.050	0.063	0.076
			MXDRC		5							
			MXDCL		12							
Stainless Steel - Difficult to Machine 302B, 304B, 309, 310, 316, 316B, 316L, 316Ti, 317, 317L, 321, PH13-8Mo, Nitronics	M	over 28 Rc	MXDSR		5	18	0.005	0.010	0.018	0.023	0.028	0.036
			MPDCS		2	18	-	0.010	0.018	0.023	0.028	0.036
			MXDRC		5							
			MXDCL		12							
Titanium Alloys 6Al-4V, 5Al-2.5 Sn, 6Al-2 Sn-4Zr-6Mo, 3Al-8V-6Cr4Mo-4Zr, 10V-2Fe-3Al, 13V-11Cr-3Al	S	up to 40 Rc	MXDSR		5	20	0.013	0.025	0.038	0.050	0.063	0.076
			MPDCS		2	55	-	0.025	0.038	0.050	0.063	0.076
			MXDRC		5							
			MXDCL		12							
High Temp Alloys Nimonics, Inconel, Monel, Hastelloy Waspeloy	S	up to 40 Rc	MXDSR		5	18	0.005	0.010	0.018	0.023	0.028	0.036
			MPDCS		2	24	-	0.010	0.018	0.023	0.028	0.036
			MXDRC		5							
			MXDCL		12							

Safety Note

Always wear the appropriate personal protective equipment such as safety glasses and protective clothing when using solid carbide or HSS cutting tools. Machines should be fully guarded.

Twister® XD High Performance Drills - 12⁺xD

Series 2XDCEM Recommended cutting data

Conditions de coupe recommandées | Empfohlene Schnittdaten | Dati di taglio raccomandati | Zalecane dane o cięciu (Zalecane parametry skrawania)

Workpiece Material Groups	Vc (m/min)	Tool Diameter (mm)								
		3	4	5	6	7	8	9	10	12
		Feed (mm/rev)								
Low Carbon Steel <0.3%C	105	0.05	0.075	0.088	0.106	0.127	0.193	0.215	0.238	0.254
Structural Steel	120	0.05	0.075	0.088	0.106	0.127	0.193	0.215	0.238	0.254
Medium Carbon Steel	80	0.05	0.075	0.088	0.106	0.127	0.193	0.215	0.238	0.254
Tool & Die Steel	80	0.05	0.075	0.088	0.106	0.127	0.193	0.215	0.238	0.254
Alloy Steel	80	0.05	0.075	0.088	0.106	0.127	0.193	0.215	0.238	0.254
Grey Cast Iron	120	0.06	0.078	0.1	0.12	0.14	0.2	0.215	0.24	0.254
Ductile Cast Iron	80	0.06	0.078	0.1	0.12	0.14	0.2	0.215	0.24	0.254
Austenitic Stainless	55	0.05	0.071	0.09	0.105	0.127	0.193	0.215	0.238	0.254
Ph Stainless	40	0.05	0.071	0.09	0.105	0.127	0.193	0.215	0.238	0.254
Martensitic Stainless	40	0.05	0.071	0.09	0.105	0.127	0.193	0.215	0.238	0.254
Ferritic Stainless	75	0.05	0.071	0.09	0.105	0.127	0.193	0.215	0.238	0.254
High Temp Alloys	20-25	0.017	0.022	0.03	0.035	0.048	0.063	0.071	0.078	0.085
Titanium Alloys	45	0.03	0.04	0.05	0.06	0.071	0.12	0.127	0.14	0.152
Hardened Steel (35-45 Hrc)	35	0.012	0.015	0.02	0.022	0.027	0.048	0.053	0.06	0.066
Hardened Steel (46-55 Hrc)	25	0.012	0.015	0.02	0.022	0.027	0.048	0.053	0.06	0.066
Non Ferrous-Al<14%Si	150	0.083	0.11	0.14	0.17	0.195	0.28	0.314	0.35	0.378
Non Ferrous-Al>14%Si	105	0.083	0.11	0.14	0.17	0.195	0.28	0.314	0.35	0.378
Non Ferrous-Brass	120	0.053	0.071	0.088	0.106	0.127	0.279	0.314	0.35	0.378
Cu/Cu Alloys/Magnesium	90	0.053	0.071	0.088	0.106	0.127	0.279	0.314	0.35	0.378

RPM Formula For Metric Drills Only - $RPM = (Vc \times 318.0) \div \text{Drill } \varnothing D^1$

Feedrate Formula For Metric Drills - $\text{Feed} = RPM \times \text{mm/rev}$

Twister® 2XDCEM, MXDCL & CXDCLM 15X

Process For Successful Deep Hole Drilling:

1. Start by producing a 1.5 x diameter to 3 x diameter pilot hole using a coolant or non-coolant pilot drill. Typically this tool will have a point angle the same as or greater than the deep hole drill. Run this drill at 100% of the final drill speed and 1/2 the normal IPM.
2. Retract and tool change to the final deep hole (2XDCE MA Ford® Series) drill.
3. Rapid to clearance plane and enter the pilot hole at 25% (don't exceed 400 to 500 RPM) of the final speed and 25 - 50 mm/min. This will help with true position by eliminating drill whip. Once into the hole, turn on the coolant and advance to the material start. At this point, you can add a dwell to clear any chips that have been left from the previous drill and let the spindle get to full speed. Increase the speed and feed to final drilling parameters.
4. Drill one shot to the final hole depth or through.
5. Should you experience any squeaking you may need to retract the drill and increase your feed. Chip packing is occurring and will need to be addressed.
6. Once through the material, it may be necessary to reduce the RPM to eliminate breakage of the drill due to drill whip. Then retract to the clearance plane.

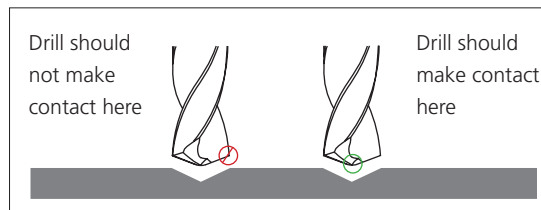

Machine Requirements

High Pressure Pump System (70 Bar)
Machine runout of 0.008mm Max.

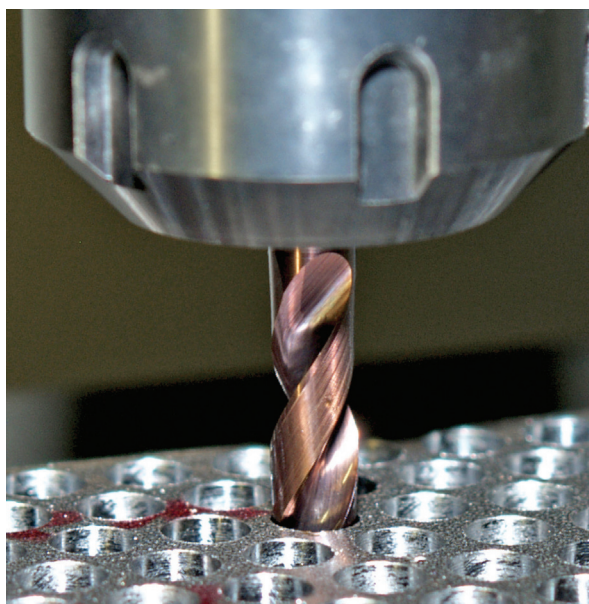

Due to the conditions of equipment, tool holders, and conditions beyond MA Ford®'s control, your results may vary.

Should your application require more in depth discussion or a special tool, please contact M.A. Ford®'s Application Engineering Department at +44(0) 1332 267960.

Safety Note

Always wear the appropriate personal protective equipment such as safety glasses and protective clothing when using solid carbide or HSS cutting tools. Machines should be fully guarded. Technical data provided should be considered advisory only as variations may be necessary depending on the particular application.

CYCLONE CDA High Performance Aluminium Drill - 5xD

Series CDACRM Aluminium Drill Recommended cutting data

Conditions de coupe recommandées | Empfohlene Schnittdaten | Dati di taglio raccomandati | Zalecane dane o cięciu (Zalacane parametry skrawania)

Work piece Material Group	ISO	Hardness	vc - m/min			Drill Diameter (mm)						
			Min	Starting Value	Max	3.0	4.0	6.0	8.0	10.0	12.0	
						f - mm/Rev						
Aluminium & Aluminium Wrought Alloys	N	10	60-100 Brinell HB	120	230	450	0.13-0.25	0.14-0.29	0.17-0.35	0.21-0.42	0.27-0.50	0.33-0.57
Cast Aluminium Alloys		20	75-90 Brinell HB	120	220	350	0.14-0.23	0.15-0.28	0.17-0.34	0.22-0.39	0.29-0.46	0.34-0.54
Aluminium Alloys Cast 13-22% Si		30		100	180	400	0.13-0.18	0.14-0.19	0.16-0.25	0.20-0.30	0.28-0.37	0.33-0.24
Copper and Copper Alloys Brass, Bronze, Copper		40	90-110 Brinell HB	100	130	300	0.10-0.16	0.12-0.18	0.14-0.24	0.16-0.28	0.18-0.32	0.20-0.36

 APG
ADVANCED PRODUCT GROUP

CYCLONE CXD High Performance Drill - Series CXDCEM 15xD

Recommended cutting data | Conditions de coupe recommandées | Empfohlene Schnittdaten | Dati di taglio Raccomandati | Zalecane Parametry

Workpiece Material Group	ISO	Hardness	TYPE	DEPTH	vc- m/min.	Drill Diameter (mm)									
						3	4	5	6	7	8	9	10	12	
						f - mm/Rev									
Free Machining & Low Carbon Steels 1006, 1008, 1015, 1018, 1020, 1022, 1025, 1117, 1140, 1141, 11L08, 11L14, 1213, 12L13, 12L14, 1215, 1330	P	up to 28 Rc		15X	105	.053	.070	.088	.106	.127	.193	.215	.238	.254	
Medium Carbon & High Carbon Steels, Alloy Steels & Easy to Machine Tool Steels 1030, 1035, 1040, 1045, 1050, 1052, 1055, 1060, 1085, 1095, 1541, 1551, 9255, 2515, 3135, 3415, 4130, 4137, 4140, 4150, 4320, 4340, 4520, 5015, 5115, 5120, 5132, 5140, 5155, 6150, 8620, 9262, 9840, 52100, O1, O2, O6, S2, W1 to W310	P	28 to 35 Rc		15X	80	.053	.070	.088	.106	.127	.193	.215	.238	.254	
Tool Steels & Die Steels O7, M1, M2, M3, M4, M7, T1, T2, T4, T5, T8, T15, A2, A3, A6, A7, H10, H11, H12, H13, H19, H21, L3, L6, L7, P2, P20, S1, S5, S7, 52100, A128, D2, D3, D4, D5, D7	P	28 to 35 Rc		15X	80	.053	.070	.088	.106	.127	.193	.215	.238	.254	
Hardened Steels	H	35-45 Rc		15X	35	.012	.016	.020	.022	.027	.046	.053	.060	.066	
Hardened Steels		45-55 Rc	25												
Stainless Steel - Easy to Machine 430F, 301, 303, 410, 416 Annealed, 420F, 430	M	up to 28 Rc		15X	90	.053	.070	.090	.105	.127	.193	.215	.238	.254	
Stainless Steel - Moderately Difficult 301, 302, 303 High Tensile, 304, 304L, 305, 420, 15-5PH, 17-4PH, 17-7PH	M	up to 28 Rc		15X	55	.053	.070	.090	.105	.127	.193	.215	.238	.254	
Stainless Steel - Difficult to Machine 302B, 304B, 309, 310, 316, 316L, 316L, 316Ti, 317, 317L, 321, PH13-8Mo, Nitronics	M	over 28 Rc		15X	40	.053	.070	.090	.105	.127	.193	.215	.238	.254	
High Temp Alloys Nimonic, Inconel, Monel, Hastelloy	S	up to 42 Rc		15X	20-25	.015	.020	.030	.035	.048	.051	.071	.078	.085	
Titanium Alloys 6Al-4V, 5Al-2.5 Sn, 6Al-2 Sn-4Zr-6Mo, 3Al-8V-6Cr-4Mo-4Zr, 10V-2Fe-3Al, 13V-11Cr-3Al	S	up to 42 Rc		15X	45	.025	.033	.050	.060	.071	.098	.127	.140	.152	
Cast Iron - Gray CG, ASTM A48, CLASS 20, 25, 30, 35, SAE J431C, GRADES G1800, G3000, G3500, GG 10, 15, 20, 25, 30, 35, 40	K	up to 240 HB		15X	120	.053	.070	.100	.120	.140	.200	.215	.240	.254	
Cast Iron - Ductile & Malleable CGI 60-40-18, 65-45-12, D4018, D4512, D5506, 32510, 35108, M3210, M4504, M5503, 250, 300, 350, 400, 450	K	over 240 HB		15X	80	.053	.070	.100	.120	.140	.200	.215	.240	.254	

Safety Note

Always wear the appropriate personal protective equipment such as safety glasses and protective clothing when using solid carbide or HSS cutting tools. Machines should be fully guarded.

Please use corresponding diameter CXD drill for creating 1.5 to 3 x diameter pilot hole, prior to deep hole drilling with the CXDCEM drill.



Recommended Cutting Data CXD ≤ 6mm - Metric

Conditions de coupe recommandées CXD ≤ 6mm - Métrique

Empfohlene Schnittdaten CXD ≤ 6 mm – metrisch

Dati di taglio raccomandati CXD ≤ 6mm - Metrici

Zalecane dane o cięciu (Zalacane parametry skrawania) CXD ≤ 6 mm – metryczne

Workpiece Material Group	ISO	Hardness	Tool Series	TYPE	DEPTH	Drill Diameter (mm)				Drill Diameter (mm)			
						3	4	5	6	3	4	5	6
						vc - m/min				f - mm/Rev			
Free Machining & Low Carbon Steels 1006, 1008, 1015, 1018, 1020, 1022, 1025, 1117, 1140, 1141, 11L08, 11L14, 1213, 12L13, 12L14, 1215, 1330	P	up to 28 Rc	CXDSS		3	119	116	113	110	.076-.127	.102-.152	.127-.178	.127-.203
			CXDSR		5	119	116	113	110				
			CXDSCS		3	201	198	195	192	.076-.127	.102-.152	.127-.178	.127-.203
			CXDSCR		5	201	198	195	192				
			CXDCL		8	181	177	171	165				
Medium Carbon & High Carbon Steels, Alloy Steels & Easy to Machine Tool Steels 1030, 1035, 1040, 1045, 1050, 1052, 1055, 1060, 1085, 1095, 1541, 1551, 9255, 2515, 3135, 3415, 4130, 4137, 4140, 4150, 4320, 4340, 4520, 5015, 5115, 5120, 5132, 5140, 5155, 6150, 8620, 9262, 9840, 52100, O1, O2, O6, S2, W1 to W310	P	28 to 38 Rc	CXDSS		3	101	98	94	91	.076-.127	.102-.152	.127-.178	.127-.203
			CXDSR		5	101	98	94	91				
			CXDSCS		3	175	168	165	152	.076-.127	.102-.152	.127-.178	.127-.203
			CXDSCR		5	175	168	165	152				
			CXDCL		8	131	128	125	122				
Tool Steels & Die Steels O7, M1, M2, M3, M4, M7, T1, T2, T4, T5, T8, T15, A2, A3, A6, A7, H10, H11, H12, H13, H19, H21, L3, L6, L7, P2, P20, S1, S5, S7, 52100, A128, D2, D3, D4, D5, D7	P	28 to 44 Rc	CXDSS		3	61	58	58	56	.036-.076	.061-.102	.076-.127	.089-.152
			CXDSR		5	61	58	58	56				
			CXDSCS		3	76	73	70	67	.036-.076	.061-.102	.076-.127	.089-.152
			CXDSCR		5	76	73	70	67				
			CXDCL		8	69	67	66	62				
Stainless Steel - Easy to Machine 430F, 301, 303, 410, 416 Annealed, 420F, 430	M	up to 28 Rc	CXDSS		3	107	104	101	98	.076-.127	.102-.152	.127-.178	.127-.203
			CXDSR		5	107	104	101	98				
			CXDSCS		3	168	152	145	137	.076-.127	.102-.152	.127-.178	.127-.203
			CXDSCR		5	168	152	145	137				
			CXDCL		8	137	130	122	116				
Stainless Steel - Moderately Difficult 301, 302, 303 High Tensile, 304, 304L, 305, 420, 15-5PH, 17-4PH, 17-7PH	M	up to 28 Rc	CXDSS		3	43	41	40	38	.076-.127	.102-.152	.127-.178	.127-.203
			CXDSR		5	43	41	40	38				
			CXDSCS		3	91	88	85	82	.076-.127	.102-.152	.127-.178	.127-.203
			CXDSCR		5	91	88	85	82				
			CXDCL		8	85	82	79	76				
Stainless Steel - Difficult to Machine 302B, 304B, 309, 310, 316, 316B, 316L, 316Ti, 317, 317L, 321, PH13-8Mo, Nitronics	M	over 28 Rc	CXDSS		3	43	40	37	34	.051-.076	.061-.089	.089-.102	.076-.127
			CXDSR		5	43	40	37	34				
			CXDSCS		3	81	76	73	70	.051-.076	.061-.089	.089-.102	.076-.127
			CXDSCR		5	81	76	73	70				
			CXDCL		8	58	55	52	49				
High Temp Alloys Nimonic, Inconel, Monel, Hastelloy	S	up to 42 Rc	CXDSS		3	26	24	23	21	.036-.089	.036-.089	.051-.102	.061-.127
			CXDSR		5	26	24	23	21				
			CXDSCS		3	35	30	29	27	.036-.089	.036-.089	.051-.102	.061-.127
			CXDSCR		5	35	30	29	27				
			CXDCL		8	30	30	29	29				
Titanium Alloys 6Al-4V, 5Al-2.5 Sn, 6Al-2 Sn-4Zr-6Mo, 3Al-8V-6Cr4Mo-4Zr, 10V-2Fe-3Al, 13V-11Cr-3Al	S	up to 42 Rc	CXDSS		3	40	38	37	35	.076-.102	.102-.152	.127-.178	.140-.229
			CXDSR		5	40	38	37	35				
			CXDSCS		3	70	67	64	61	.076-.102	.102-.152	.127-.178	.140-.229
			CXDSCR		5	70	67	64	61				
			CXDCL		8	64	58	55	52				
Cast Iron Gray CG, ASTM A48, CLASS 20, 25, 30, 35, SAE J431C, GRADES G1800, G3000, G3500, GG 10, 15, 20, 25, 30, 35, 40	K	up to 240 HB	CXDSS		3	146	143	140	131	.076-.127	.102-.152	.127-.178	.127-.203
			CXDSR		5	146	143	140	131				
			CXDSCS		3	201	195	189	183	.076-.127	.102-.152	.127-.178	.127-.203
			CXDSCR		5	201	195	189	183				
			CXDCL		8	152	149	146	143				
Cast Iron - Ductile & Malleable CGI 60-40-18, 65-45-12, D4018, D4512, D5506, 32510, 35108, M3210, M4504, M5503, 250, 300, 350, 400, 450	K	over 240 HB	CXDSS		3	85	82	79	76	.076-.127	.102-.152	.127-.178	.127-.203
			CXDSR		5	85	82	79	76				
			CXDSCS		3	122	146	140	134	.076-.127	.102-.152	.127-.178	.127-.203
			CXDSCR		5	122	146	140	134				
			CXDCL		8	107	104	101	98				



Drill Troubleshooting

Dépannage Foret | Fehlerbehebung Bohrer | Risoluzione dei problemi relativi alla foratura | Diagnostowanie usterek wiertel

Possible Solutions	Problem																																
	Tool Deterioration										Chip Formation			Tool Life	Workpiece					Process													
	Flank wear	Margin wear	Breakage	Flaking	Creater wear	Chisel edge wear	Corner chipping	Flute chipping	Cutting edge chipping	Cutting edge wear	Point center chipping	Rake face	Scoring on tool body	Long stringy	Varied chip form	Blue/brown chips	Tool Life	Undersized hole	Oversized hole	Poor alignment	Poor surface finish	Heavy burr breakout	Retract marks	Hole location	Hole straightness	Deflection	Point Deflection	Galling	Vibration	Abnormal noise	Chip packing	No drill penetration	
Reduce feed or reduce at exit	x	x				x	x	x	x	x	x	x					x	x	x	x	x			x								x	
Reduce feed at entrance			x															x		x				x	x							x	
Consistent feed rate			x										x	x															x			x	
Increase feed	x					x							x					x	x														
Reduce speed	x	x			x		x			x							x	x										x		x	x		
Increase speed																					x												
Coolant mix		x	x	x				x				x					x	x		x	x											x	
Coolant increase flow	x	x				x	x	x							x		x	x		x	x											x	
Coolant filter	x	x	x					x									x	x		x	x											x	
Workpiece clamp rigid		x	x			x	x	x				x					x		x	x	x	x	x	x	x							x	
Collet accuracy			x					x											x						x	x				x			
Tool holder fit .0008			x					x											x					x	x					x			
Alignment			x					x											x														x
Peck drill			x																														
Concentricity		x	x	x				x	x				x							x	x			x	x	x		x		x			
Do not extract tool during peck								x																									

Recommended Minimum Coolant Pressure

Pression minimale recommandée pour le liquide de coupe | Empfohlener Mindestdruck für Kühlmittel
 Pressione minima del refrigerante consigliata | Zalecane minimalne ciśnienie chłodziwa

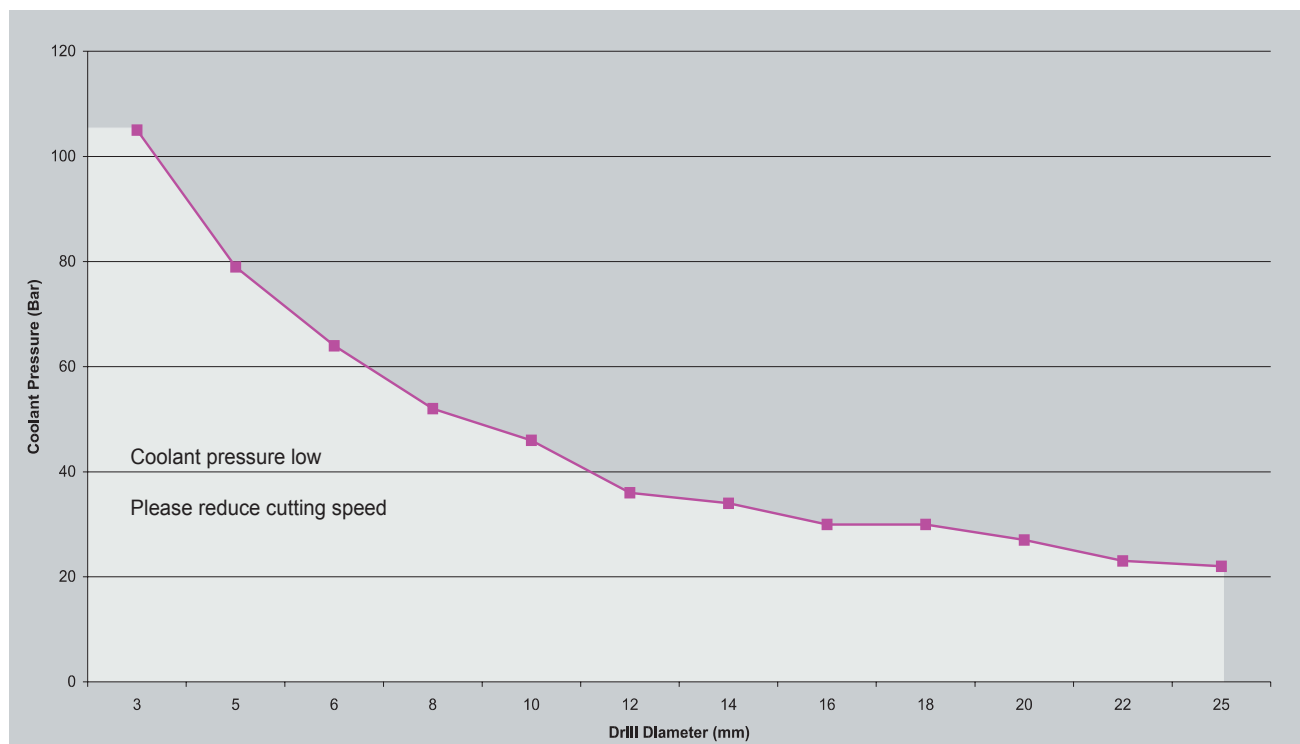



EN

Our FordMax drills range is one of the most comprehensive available and covering high-precision micro and circuit board drills up to high performance, large diameter drills for machining aluminium, stainless steel and exotic alloys, as well as our HSSCo Platinum drills for steel, stainless steels, copper and aluminium.

FR

“Notre gamme de forets FordMax est l’une des plus complètes, disponibles sur le marché, elle couvre depuis les forets de grande précision et forets pour circuit imprimé jusqu’aux forets haute performance, une gamme large de diamètres pour l’usinage de l’aluminium, de l’acier inoxydable et des alliages exotiques, aussi bien que nos forets en Platinum HSSCo pour l’acier, l’acier inoxydable, le cuivre et l’aluminium.”

DE

Unser Sortiment der FordMax-Bohrer gehört zu den umfangreichsten, auf dem Markt erhältlichen Produktpaletten. Es umfasst Hochpräzisions-Mikrobohrer und Bohrer für Leiterplatten sowie Hochleistungsbohrer, Bohrer mit großem Durchmesser zur Bearbeitung von Aluminium, Edelstahl und Sonderlegierungen sowie unsere HSSCo-Platinbohrer für Stahl, rostfreien Stahl, Kupfer und Aluminium.

IT

La nostra gamma di punte FordMax è una tra le più complete e comprende, tra l’altro, micropunte ad alta precisione e per circuiti stampati, punte ad elevate prestazioni, punte di grandi diametri per lavorazioni di alluminio, acciaio inossidabile e materiali esotici. La serie Platinum in HSSCo è idonea per acciaio, acciaio inossidabile, rame e alluminio.

PL

Zakres wiertel FordMax jest jednym z najbardziej wszechstronnych i dostępnych. Obejmuje precyzyjne i wysokowydajne mikro wiertła i wiertła z płytkami lutowanymi o szerokim zakresie średnic do obróbki aluminium, stali nierdzewnej i stopów egzotycznych, a także wiertła HSSCo Platinum do stali, stali nierdzewnych, miedzi i aluminium.

Twister® Solid Carbide & HSSCo Platinum Drills

General Purpose Drills

Forets pour utilisation générale ; Universalbohrer
Punte per uso generale ; Wiertła ogólnego przeznaczenia

	Page
Twister® Micro Drill Series 302 Uncoated	158
Twister® Hi-Roc® Drill 3xD Series 200 Uncoated	159 - 160
Twister® Kevlar/Composite Drill 3xD Series 207 Uncoated	161
Twister® Hi-Tuff® Drill 5xD Series 205 Uncoated	162 - 163
Twister® Micro Drill 5xD Series 300 Uncoated	164
Twister® Performance Drill 3xD Series HPDSS, HPDCS	165 - 167
Twister® Performance Drill 5xD Series HPDSR, HPDCR	168 - 170
Twister® X-AL 3 Flute Performance Aluminium Drill 4-5xD Series 229	171
Twister® Hi-Tuff® Jobbers Drill 5xD Series 224 Uncoated	172 - 173
Twister® Centre Drill Series 402 Uncoated	174
Twister® 90° NC Spot Drill Series 404 Uncoated	175
Twister® 120° NC Spot Drill Series 403 Uncoated	176
HSSCo Platinum Drills Series PRM-KSN	176
HSSCo Platinum Drills Series PRXS-KST	177 - 178
HSSCo Platinum Drills Series PRXS-KMT	178 - 179
Technical Information	180 - 184



Twister® Micro Drill Series 302 Uncoated

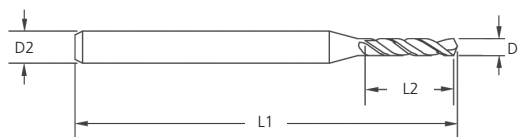
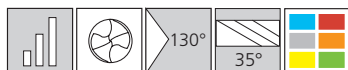

Series 302	Drill Dimensions			
Tool No	Ø D1	Ø D2	L1	L2
302 0010	0.1	3.175	38.1	1.7
302 0015	0.15	3.175	38.1	2.5
302 0020	0.2	3.175	38.1	3.2
302 0025	0.25	3.175	38.1	3.8
302 0030	0.3	3.175	38.1	5.0
302 0035	0.35	3.175	38.1	5.0
302 0035-1	0.35	3.175	38.1	6.0
302 0040	0.4	3.175	38.1	5.0
302 0040-1	0.4	3.175	38.1	6.0
302 0045	0.45	3.175	38.1	5.0
302 0045-1	0.45	3.175	38.1	6.0
302 0045-2	0.45	3.175	38.1	8.0
302 0050	0.5	3.175	38.1	5.0
302 0050-1	0.5	3.175	38.1	6.0
302 0050-2	0.5	3.175	38.1	8.0
302 0055	0.55	3.175	38.1	5.0
302 0055-1	0.55	3.175	38.1	6.0
302 0055-2	0.55	3.175	38.1	8.0
302 0060	0.6	3.175	38.1	5.0
302 0060-1	0.6	3.175	38.1	6.0
302 0060-2	0.6	3.175	38.1	8.0
302 0065	0.65	3.175	38.1	5.0
302 0065-1	0.65	3.175	38.1	6.0
302 0065-2	0.65	3.175	38.1	8.0
302 0070	0.7	3.175	38.1	6.0
302 0070-1	0.7	3.175	38.1	8.0
302 0070-2	0.7	3.175	38.1	10.2
302 0075	0.75	3.175	38.1	6.0
302 0075-1	0.75	3.175	38.1	8.0
302 0075-2	0.75	3.175	38.1	10.2
302 0080	0.8	3.175	38.1	6.0
302 0080-1	0.8	3.175	38.1	10.2
302 0085	0.85	3.175	38.1	6.0
302 0085-1	0.85	3.175	38.1	10.2
302 0090	0.9	3.175	38.1	10.2
302 0095	0.95	3.175	38.1	10.2
302 0100	1.0	3.175	38.1	10.2
302 0105	1.05	3.175	38.1	10.2
302 0110	1.1	3.175	38.1	10.2
302 0115	1.15	3.175	38.1	10.2

Series 302	Drill Dimensions			
Tool No	Ø D1	Ø D2	L1	L2
302 0120	1.2	3.175	38.1	10.2
302 0125	1.25	3.175	38.1	10.2
302 0130	1.3	3.175	38.1	10.2
302 0135	1.35	3.175	38.1	10.2
302 0140	1.4	3.175	38.1	10.2
302 0145	1.45	3.175	38.1	10.2
302 0150	1.5	3.175	38.1	10.2
302 0155	1.55	3.175	38.1	10.2
302 0160	1.6	3.175	38.1	10.2
302 0165	1.65	3.175	38.1	10.2
302 0170	1.7	3.175	38.1	10.2
302 0175	1.75	3.175	38.1	10.2
302 0180	1.8	3.175	38.1	10.2
302 0185	1.85	3.175	38.1	10.2
302 0190	1.9	3.175	38.1	10.2
302 0195	1.95	3.175	38.1	10.2
302 0200	2.0	3.175	38.1	10.2
302 0205	2.05	3.175	38.1	10.2
302 0210	2.1	3.175	38.1	10.2
302 0215	2.15	3.175	38.1	10.2
302 0220	2.2	3.175	38.1	10.2
302 0225	2.25	3.175	38.1	10.2
302 0230	2.3	3.175	38.1	10.2
302 0235	2.35	3.175	38.1	10.2
302 0240	2.4	3.175	38.1	10.2
302 0245	2.45	3.175	38.1	10.2
302 0250	2.5	3.175	38.1	10.2
302 0255	2.55	3.175	38.1	10.2
302 0260	2.6	3.175	38.1	10.2
302 0265	2.65	3.175	38.1	10.2
302 0270	2.7	3.175	38.1	10.2
302 0275	2.75	3.175	38.1	10.2
302 0280	2.8	3.175	38.1	10.2
302 0285	2.85	3.175	38.1	10.2
302 0290	2.9	3.175	38.1	10.2
302 0295	2.95	3.175	38.1	10.2
302 0300	3.0	3.175	38.1	10.2
302 0305	3.05	3.175	38.1	10.2
302 0310	3.1	3.175	38.1	10.2
302 0315	3.15	3.175	38.1	10.2



Twister® Hi-Roc® Drill - 3xD Series 200 Uncoated

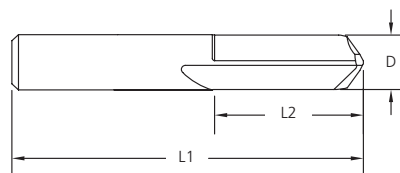

Series 200	Drill Dimensions		
Tool No	Ø D	L1	L2
200 0080	0.8	38.0	5.0
200 0085	0.85	38.0	5.5
200 0090	0.9	38.0	5.5
200 0095	0.95	38.0	6.0
200 0100	1.0	38.0	6.5
200 0105	1.05	38.0	6.5
200 0110	1.1	38.0	6.5
200 0115	1.15	38.0	6.5
200 0120	1.2	38.0	8.0
200 0125	1.25	38.0	8.0
200 0130	1.3	38.0	8.0
200 0135	1.35	38.0	8.0
200 0140	1.4	38.0	8.0
200 0145	1.45	38.0	8.0
200 0150	1.5	38.0	8.0
200 0160	1.6	38.0	8.0
200 0170	1.7	38.0	9.5
200 0180	1.8	38.0	9.5
200 0190	1.9	38.0	9.5
200 0200	2.0	38.0	9.5
200 0210	2.1	38.0	12.5
200 0220	2.2	38.0	12.5
200 0230	2.3	38.0	12.5
200 0240	2.4	38.0	12.5
200 0250	2.5	38.0	12.5
200 0260	2.6	38.0	16.0
200 0270	2.7	38.0	16.0
200 0280	2.8	38.0	16.0
200 0290	2.9	38.0	16.0
200 0300	3.0	38.0	16.0
200 0310	3.1	38.0	16.0
200 0320	3.2	38.0	16.0
200 0330	3.3	38.0	16.0
200 0340	3.4	51.0	16.0
200 0350	3.5	51.0	16.0
200 0360	3.6	51.0	16.0
200 0370	3.7	51.0	16.0
200 0380	3.8	51.0	16.0
200 0390	3.9	51.0	16.0
200 0400	4.0	51.0	16.0
200 0410	4.1	51.0	16.0
200 0420	4.2	51.0	16.0
200 0430	4.3	51.0	16.0
200 0440	4.4	51.0	16.0
200 0450	4.5	51.0	16.0

Series 200	Drill Dimensions		
Tool No	Ø D	L1	L2
200 0460	4.6	51.0	16.0
200 0470	4.7	51.0	16.0
200 0480	4.8	51.0	16.0
200 0490	4.9	51.0	16.0
200 0500	5.0	51.0	19.0
200 0510	5.1	51.0	19.0
200 0520	5.2	51.0	19.0
200 0530	5.3	51.0	19.0
200 0540	5.4	51.0	19.0
200 0550	5.5	51.0	19.0
200 0560	5.6	51.0	19.0
200 0570	5.7	51.0	19.0
200 0580	5.8	51.0	19.0
200 0590	5.9	51.0	19.0
200 0600	6.0	51.0	19.0
200 0610	6.1	51.0	19.0
200 0620	6.2	51.0	19.0
200 0630	6.3	51.0	19.0
200 0640	6.4	51.0	19.0
200 0650	6.5	51.0	19.0
200 0660	6.6	64.0	19.0
200 0670	6.7	64.0	19.0
200 0680	6.8	64.0	19.0
200 0690	6.9	64.0	19.0
200 0700	7.0	64.0	19.0
200 0710	7.1	64.0	19.0
200 0720	7.2	64.0	19.0
200 0730	7.3	64.0	19.0
200 0740	7.4	64.0	19.0
200 0750	7.5	64.0	19.0
200 0760	7.6	64.0	19.0
200 0770	7.7	64.0	19.0
200 0780	7.8	64.0	19.0
200 0790	7.9	64.0	19.0
200 0800	8.0	64.0	19.0
200 0810	8.1	64.0	19.0
200 0820	8.2	64.0	25.5
200 0830	8.3	64.0	25.5
200 0840	8.4	64.0	25.5
200 0850	8.5	64.0	25.5
200 0860	8.6	64.0	25.5
200 0870	8.7	64.0	25.5
200 0880	8.8	64.0	25.5
200 0890	8.9	64.0	25.5
200 0900	9.0	64.0	25.5



Twister® Hi-Roc® Drill - 3xD Series 200 Uncoated

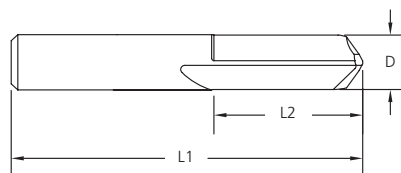
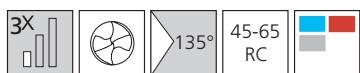

Series 200	Drill Dimensions		
Tool No	Ø D	L1	L2
200 0910	9.1	64.0	25.5
200 0920	9.2	64.0	25.5
200 0930	9.3	64.0	25.5
200 0940	9.4	64.0	25.5
200 0950	9.5	64.0	25.5
200 0960	9.6	64.0	25.5
200 0970	9.7	70.0	25.5
200 0980	9.8	70.0	25.5
200 0990	9.9	70.0	25.5
200 1000	10.0	70.0	25.5
200 1010	10.1	70.0	25.5
200 1020	10.2	70.0	25.5
200 1030	10.3	70.0	25.5
200 1040	10.4	70.0	25.5
200 1050	10.5	70.0	25.5
200 1060	10.6	70.0	25.5
200 1070	10.7	70.0	25.5
200 1080	10.8	70.0	25.5
200 1090	10.9	70.0	25.5
200 1100	11.0	70.0	25.5
200 1110	11.1	70.0	25.5
200 1120	11.2	70.0	25.5
200 1130	11.3	76.0	25.5

Series 200	Drill Dimensions		
Tool No	Ø D	L1	L2
200 1140	11.4	76.0	25.5
200 1150	11.5	76.0	25.5
200 1160	11.6	76.0	25.5
200 1170	11.7	76.0	25.5
200 1180	11.8	76.0	25.5
200 1190	11.9	76.0	25.5
200 1200	12.0	76.0	25.5
200 1250	12.5	76.0	25.5
200 1300	13.0	89.0	28.5
200 1350	13.5	89.0	28.5
200 1400	14.0	89.0	28.5
200 1450	14.5	89.0	32.0
200 1500	15.0	89.0	32.0
200 1550	15.5	89.0	32.0
200 1600	16.0	89.0	32.0
200 1650	16.5	102.0	38.0
200 1700	17.0	102.0	38.0
200 1750	17.5	102.0	38.0
200 1800	18.0	102.0	38.0
200 1850	18.5	102.0	38.0
200 1900	19.0	102.0	38.0
200 2000	20.0	102.0	38.0



Twister® Kevlar/Composite Drill - 3xD Series 207 Uncoated

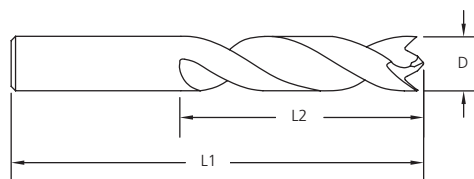

Series 207	Drill Dimensions		
Tool No	Ø D	L1	L2
207 0240	2.4	44.0	12.5
207 0250	2.5	46.0	12.5
207 0260	2.6	46.0	12.5
207 0270	2.7	46.0	12.5
207 0280	2.8	48.0	16.0
207 0290	2.9	48.0	16.0
207 0300	3.0	48.0	16.0
207 0310	3.1	48.0	16.0
207 0320	3.2	48.0	16.0
207 0330	3.3	49.0	17.5
207 0340	3.4	49.0	17.5
207 0350	3.5	49.0	17.5
207 0360	3.6	49.0	17.5
207 0370	3.7	52.0	19.0
207 0380	3.8	52.0	19.0
207 0390	3.9	52.0	19.0
207 0400	4.0	54.0	22.0
207 0410	4.1	54.0	22.0
207 0420	4.2	54.0	22.0
207 0430	4.3	54.0	22.0
207 0440	4.4	56.0	24.0
207 0450	4.5	56.0	24.0
207 0460	4.6	56.0	24.0
207 0470	4.7	56.0	24.0
207 0480	4.8	57.0	25.5
207 0490	4.9	57.0	25.5
207 0500	5.0	57.0	25.5

Series 207	Drill Dimensions		
Tool No	Ø D	L1	L2
207 0510	5.1	57.0	25.5
207 0520	5.2	60.0	27.0
207 0530	5.3	60.0	27.0
207 0540	5.4	60.0	27.0
207 0550	5.5	60.0	27.0
207 0560	5.6	62.0	28.5
207 0570	5.7	62.0	28.5
207 0580	5.8	62.0	28.5
207 0590	5.9	62.0	28.5
207 0600	6.0	64.0	32.0
207 0610	6.1	64.0	32.0
207 0620	6.2	64.0	32.0
207 0630	6.3	64.0	32.0
207 0640	6.4	64.0	32.0
207 0650	6.5	67.0	33.5
207 0700	7.0	68.0	35.0
207 0750	7.5	70.0	35.0
207 0800	8.0	71.0	38.0
207 0850	8.5	75.0	39.5
207 0900	9.0	78.0	39.5
207 0950	9.5	79.0	41.5
207 1000	10.0	84.0	44.5
207 1050	10.5	86.0	46.0
207 1100	11.0	87.0	47.5
207 1150	11.5	92.0	51.0
207 1200	12.0	94.0	54.0



Twister® Hi-Tuff® Drill - 5xD Series 205 Uncoated

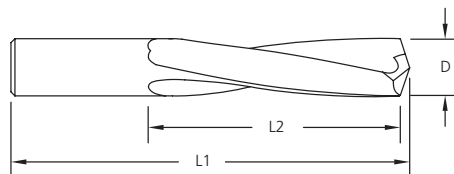
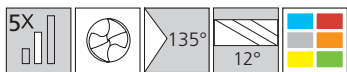

Series 205	Drill Dimensions		
Tool No	Ø D	L1	L2
205 0030	0.3	38.0	5.0
205 0035	0.35	38.0	5.0
205 0040	0.4	38.0	5.0
205 0045	0.45	38.0	5.0
205 0050	0.5	38.0	6.5
205 0055	0.55	38.0	6.5
205 0060	0.6	38.0	6.5
205 0065	0.65	38.0	8.0
205 0070	0.7	38.0	8.0
205 0075	0.75	38.0	8.0
205 0080	0.8	38.0	9.5
205 0085	0.85	38.0	9.5
205 0090	0.9	38.0	11.0
205 0095	0.95	38.0	11.0
205 0100	1.0	38.0	12.5
205 0105	1.05	38.0	12.5
205 0110	1.1	38.0	12.5
205 0115	1.15	38.0	12.5
205 0120	1.2	38.0	12.5
205 0125	1.25	41.0	16.0
205 0130	1.3	41.0	16.0
205 0135	1.35	41.0	16.0
205 0140	1.4	41.0	16.0
205 0145	1.45	41.0	16.0
205 0150	1.5	41.0	16.0
205 0160	1.6	41.0	16.0
205 0170	1.7	43.0	17.5
205 0180	1.8	43.0	17.5
205 0190	1.9	43.0	17.5
205 0200	2.0	44.0	19.0
205 0210	2.1	44.0	19.0
205 0220	2.2	44.0	19.0
205 0230	2.3	44.0	19.0
205 0240	2.4	44.0	19.0
205 0250	2.5	46.0	21.0
205 0260	2.6	46.0	20.5
205 0270	2.7	46.0	20.5
205 0280	2.8	48.0	22.0
205 0290	2.9	48.0	22.0
205 0300	3.0	48.0	22.0
205 0310	3.1	48.0	22.0
205 0320	3.2	48.0	22.0
205 0330	3.3	49.0	24.0
205 0340	3.4	49.0	24.0
205 0350	3.5	49.0	24.0

Series 205	Drill Dimensions		
Tool No	Ø D	L1	L2
205 0360	3.6	49.0	24.0
205 0370	3.7	52.0	25.5
205 0380	3.8	52.0	25.5
205 0390	3.9	52.0	25.5
205 0400	4.0	54.0	27.0
205 0410	4.1	54.0	27.0
205 0420	4.2	54.0	27.0
205 0430	4.3	54.0	27.0
205 0440	4.4	56.0	28.5
205 0450	4.5	56.0	28.5
205 0460	4.6	56.0	28.5
205 0470	4.7	57.0	30.0
205 0480	4.8	57.0	30.0
205 0490	4.9	57.0	30.0
205 0500	5.0	57.0	30.0
205 0510	5.1	57.0	30.0
205 0520	5.2	60.0	32.0
205 0530	5.3	60.0	32.0
205 0540	5.4	60.0	32.0
205 0550	5.5	60.0	32.0
205 0560	5.6	62.0	33.4
205 0570	5.7	62.0	33.4
205 0580	5.8	62.0	33.4
205 0590	5.9	62.0	33.4
205 0600	6.0	64.0	35.0
205 0610	6.1	64.0	35.0
205 0620	6.2	64.0	35.0
205 0630	6.3	64.0	35.0
205 0640	6.4	64.0	35.0
205 0650	6.5	67.0	36.5
205 0660	6.6	67.0	36.5
205 0670	6.7	67.0	38.0
205 0680	6.8	68.0	38.0
205 0690	6.9	68.0	38.0
205 0700	7.0	68.0	38.0
205 0710	7.1	68.0	38.0
205 0720	7.2	68.0	38.0
205 0730	7.3	68.0	38.0
205 0740	7.4	70.0	39.5
205 0750	7.5	70.0	39.5
205 0760	7.6	70.0	39.5
205 0770	7.7	71.0	41.5
205 0780	7.8	71.0	41.5
205 0790	7.9	71.0	41.5
205 0800	8.0	71.0	41.5

Twister® Hi-Tuff® Drill - 5xD Series 205 Uncoated

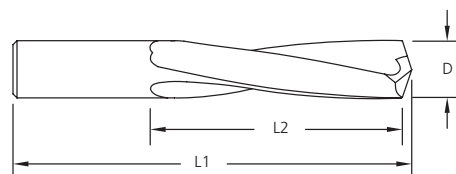
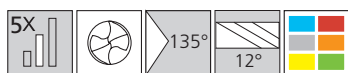

Series 205	Drill Dimensions		
Tool No	Ø D	L1	L2
205 0810	8.1	75.0	43.0
205 0820	8.2	75.0	43.0
205 0830	8.3	75.0	43.0
205 0840	8.4	75.0	43.0
205 0850	8.5	75.0	43.0
205 0860	8.6	75.0	43.0
205 0870	8.7	75.0	43.0
205 0880	8.8	75.0	43.0
205 0890	8.9	78.0	44.5
205 0900	9.0	78.0	44.5
205 0910	9.1	78.0	44.5
205 0920	9.2	78.0	44.5
205 0930	9.3	79.0	46.0
205 0940	9.4	79.0	46.0
205 0950	9.5	79.0	46.0
205 0960	9.6	83.0	47.5
205 0970	9.7	83.0	47.5
205 0980	9.8	83.0	47.5
205 0990	9.9	83.0	47.5
205 1000	10.0	84.0	49.0
205 1010	10.1	84.0	49.0
205 1020	10.2	84.0	49.0
205 1030	10.3	84.0	49.0
205 1040	10.4	84.0	49.0
205 1050	10.5	86.0	51.0
205 1060	10.6	86.0	51.0
205 1070	10.7	86.0	51.0
205 1080	10.8	86.0	51.0

Series 205	Drill Dimensions		
Tool No	Ø D	L1	L2
205 1090	10.9	87.0	52.5
205 1100	11.0	87.0	52.5
205 1110	11.1	87.0	52.5
205 1120	11.2	92.0	54.0
205 1130	11.3	92.0	54.0
205 1140	11.4	92.0	54.0
205 1150	11.5	92.0	54.0
205 1160	11.6	92.0	54.0
205 1170	11.7	92.0	54.0
205 1180	11.8	92.0	54.0
205 1190	11.9	92.0	54.0
205 1200	12.0	94.0	55.5
205 1250	12.5	95.0	57.0
205 1300	13.0	98.0	60.5
205 1350	13.5	102.0	63.5
205 1400	14.0	102.0	63.5
205 1450	14.5	105.0	66.5
205 1500	15.0	105.0	66.5
205 1550	15.5	108.0	70.0
205 1600	16.0	108.0	70.0
205 1650	16.5	114.0	73.0
205 1700	17.0	117.0	73.0
205 1750	17.5	121.0	76.0
205 1800	18.0	121.0	76.0
205 1850	18.5	127.0	79.5
205 1900	19.0	127.0	79.5
205 2000	20.0	133.0	82.5



Twister® Micro Drill 5xD Series 300 Uncoated

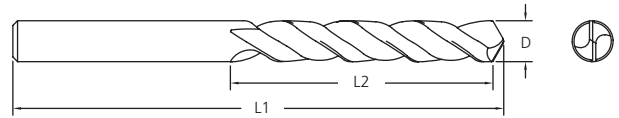
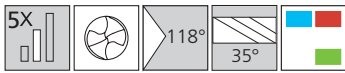

Drill Dimensions			
Tool No	Ø D	L1	L2
300 0050	0.5	38.0	9.5
300 0055	0.55	38.0	9.5
300 0060	0.6	38.0	9.5
300 0065	0.65	38.0	12.5
300 0070	0.7	38.0	12.5
300 0075	0.75	38.0	12.5
300 0080	0.8	38.0	12.5
300 0085	0.85	38.0	12.5
300 0090	0.9	38.0	16.0
300 0095	0.95	38.0	16.0
300 0100	1.0	38.0	16.0
300 0105	1.05	38.0	16.0
300 0110	1.1	38.0	16.0
300 0115	1.15	38.0	16.0
300 0120	1.2	38.0	16.0
300 0125	1.25	38.0	16.0
300 0130	1.3	38.0	16.0
300 0135	1.35	38.0	16.0
300 0140	1.4	38.0	16.0
300 0145	1.45	38.0	16.0
300 0150	1.5	38.0	16.0
300 0155	1.55	38.0	16.0
300 0160	1.6	38.0	16.0
300 0165	1.65	38.0	16.0
300 0170	1.7	38.0	16.0
300 0175	1.75	38.0	16.0
300 0180	1.8	38.0	16.0

Drill Dimensions			
Tool No	Ø D	L1	L2
300 0185	1.85	38.0	16.0
300 0190	1.9	38.0	16.0
300 0195	1.95	38.0	16.0
300 0200	2.0	38.0	16.0
300 0205	2.05	38.0	16.0
300 0210	2.1	38.0	16.0
300 0215	2.15	38.0	16.0
300 0220	2.2	38.0	16.0
300 0225	2.25	38.0	16.0
300 0230	2.3	38.0	16.0
300 0235	2.35	38.0	16.0
300 0240	2.4	38.0	16.0
300 0245	2.45	38.0	16.0
300 0250	2.5	38.0	16.0
300 0255	2.55	38.0	16.0
300 0260	2.6	38.0	16.0
300 0265	2.65	38.0	16.0
300 0270	2.7	38.0	16.0
300 0275	2.75	38.0	16.0
300 0280	2.8	38.0	16.0
300 0285	2.85	38.0	16.0
300 0290	2.9	38.0	16.0
300 0295	2.95	38.0	16.0
300 0300	3.0	38.0	16.0
300 0305	3.05	38.0	16.0
300 0310	3.1	38.0	16.0
300 0315	3.15	38.0	16.0

Drills

 Forets

 Bohrer

 Punta

 Wiertła



Twister® HPD Performance Drills - 3xD Series HPDSS, HPDCS

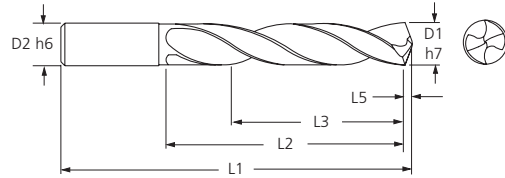
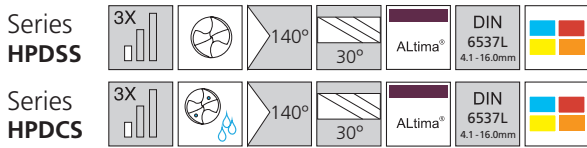

Series HPDSS	Series HPDCS	Tool Dimensions					
Tool No.	Tool No.	Ø D1	Ø D2	L1	L2 (Max.)	L3	L5
HPDSS 0300A	HPDCS 0300A	3.0	3.0	62.0	20.0	14.0	0.46
HPDSS 0310A	HPDCS 0310A	3.1	4.0	62.0	20.0	14.0	0.48
HPDSS 0320A	HPDCS 0320A	3.2	4.0	62.0	20.0	14.0	0.49
HPDSS 0330A	HPDCS 0330A	3.3	4.0	62.0	20.0	14.0	0.51
HPDSS 0340A	HPDCS 0340A	3.4	4.0	62.0	20.0	14.0	0.52
HPDSS 0350A	HPDCS 0350A	3.5	4.0	62.0	20.0	14.0	0.54
HPDSS 0360A	HPDCS 0360A	3.6	4.0	62.0	20.0	14.0	0.55
HPDSS 0370A	HPDCS 0370A	3.7	4.0	62.0	20.0	14.0	0.57
HPDSS 0380A	HPDCS 0380A	3.8	4.0	66.0	24.0	17.0	0.58
HPDSS 0390A	HPDCS 0390A	3.9	4.0	66.0	24.0	17.0	0.60
HPDSS 0400A	HPDCS 0400A	4.0	4.0	66.0	24.0	17.0	0.61
HPDSS 0410A	HPDCS 0410A	4.1	6.0	66.0	24.0	17.0	0.64
HPDSS 0420A	HPDCS 0420A	4.2	6.0	66.0	24.0	17.0	0.64
HPDSS 0430A	HPDCS 0430A	4.3	6.0	66.0	24.0	17.0	0.66
HPDSS 0440A	HPDCS 0440A	4.4	6.0	66.0	24.0	17.0	0.67
HPDSS 0450A	HPDCS 0450A	4.5	6.0	66.0	24.0	17.0	0.69
HPDSS 0460A	HPDCS 0460A	4.6	6.0	66.0	24.0	17.0	0.71
HPDSS 0470A	HPDCS 0470A	4.7	6.0	66.0	24.0	17.0	0.72
HPDSS 0480A	HPDCS 0480A	4.8	6.0	66.0	28.0	20.0	0.74
HPDSS 0490A	HPDCS 0490A	4.9	6.0	66.0	28.0	20.0	0.75
HPDSS 0500A	HPDCS 0500A	5.0	6.0	66.0	28.0	20.0	0.77
HPDSS 0510A	HPDCS 0510A	5.1	6.0	66.0	28.0	20.0	0.78
HPDSS 0520A	HPDCS 0520A	5.2	6.0	66.0	28.0	20.0	0.80
HPDSS 0530A	HPDCS 0530A	5.3	6.0	66.0	28.0	20.0	0.81
HPDSS 0540A	HPDCS 0540A	5.4	6.0	66.0	28.0	20.0	0.83
HPDSS 0550A	HPDCS 0550A	5.5	6.0	66.0	28.0	20.0	0.84
HPDSS 0560A	HPDCS 0560A	5.6	6.0	66.0	28.0	20.0	0.86
HPDSS 0570A	HPDCS 0570A	5.7	6.0	66.0	28.0	20.0	0.87
HPDSS 0580A	HPDCS 0580A	5.8	6.0	66.0	28.0	20.0	0.89
HPDSS 0590A	HPDCS 0590A	5.9	6.0	66.0	28.0	20.0	0.90
HPDSS 0600A	HPDCS 0600A	6.0	6.0	66.0	28.0	20.0	0.92
HPDSS 0610A	HPDCS 0610A	6.1	8.0	79.0	34.0	24.0	0.94
HPDSS 0620A	HPDCS 0620A	6.2	8.0	79.0	34.0	24.0	0.95
HPDSS 0630A	HPDCS 0630A	6.3	8.0	79.0	34.0	24.0	0.97
HPDSS 0640A	HPDCS 0640A	6.4	8.0	79.0	34.0	24.0	0.98
HPDSS 0650A	HPDCS 0650A	6.5	8.0	79.0	34.0	24.0	1.00
HPDSS 0660A	HPDCS 0660A	6.6	8.0	79.0	34.0	24.0	1.01
HPDSS 0670A	HPDCS 0670A	6.7	8.0	79.0	34.0	24.0	1.03
HPDSS 0680A	HPDCS 0680A	6.8	8.0	79.0	34.0	24.0	1.04
HPDSS 0690A	HPDCS 0690A	6.9	8.0	79.0	34.0	24.0	1.06
HPDSS 0700A	HPDCS 0700A	7.0	8.0	79.0	34.0	24.0	1.07
HPDSS 0710A	HPDCS 0710A	7.1	8.0	79.0	41.0	29.0	1.09
HPDSS 0720A	HPDCS 0720A	7.2	8.0	79.0	41.0	29.0	1.10
HPDSS 0730A	HPDCS 0730A	7.3	8.0	79.0	41.0	29.0	1.12



Twister® HPD Performance Drills - 3xD Series HPDSS, HPDCS

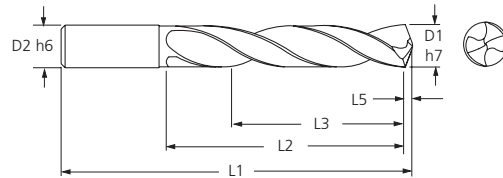
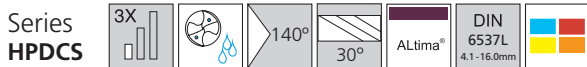
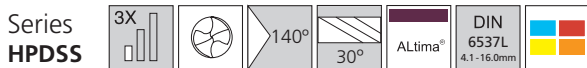

Series HPDSS	Series HPDCS	Tool Dimensions					
Tool No.	Tool No.	Ø D1	Ø D2	L1	L2 (Max.)	L3	L5
HPDSS 0740A	HPDCS 0740A	7.4	8.0	79.0	41.0	29.0	1.13
HPDSS 0750A	HPDCS 0750A	7.5	8.0	79.0	41.0	29.0	1.15
HPDSS 0760A	HPDCS 0760A	7.6	8.0	79.0	41.0	29.0	1.17
HPDSS 0770A	HPDCS 0770A	7.7	8.0	79.0	41.0	29.0	1.18
HPDSS 0780A	HPDCS 0780A	7.8	8.0	79.0	41.0	29.0	1.20
HPDSS 0790A	HPDCS 0790A	7.9	8.0	79.0	41.0	29.0	1.21
HPDSS 0800A	HPDCS 0800A	8.0	8.0	79.0	41.0	29.0	1.23
HPDSS 0810A	HPDCS 0810A	8.1	10.0	89.0	47.0	35.0	1.24
HPDSS 0820A	HPDCS 0820A	8.2	10.0	89.0	47.0	35.0	1.26
HPDSS 0830A	HPDCS 0830A	8.3	10.0	89.0	47.0	35.0	1.27
HPDSS 0840A	HPDCS 0840A	8.4	10.0	89.0	47.0	35.0	1.29
HPDSS 0850A	HPDCS 0850A	8.5	10.0	89.0	47.0	35.0	1.30
HPDSS 0860A	HPDCS 0860A	8.6	10.0	89.0	47.0	35.0	1.32
HPDSS 0870A	HPDCS 0870A	8.7	10.0	89.0	47.0	35.0	1.33
HPDSS 0880A	HPDCS 0880A	8.8	10.0	89.0	47.0	35.0	1.35
HPDSS 0890A	HPDCS 0890A	8.9	10.0	89.0	47.0	35.0	1.36
HPDSS 0900A	HPDCS 0900A	9.0	10.0	89.0	47.0	35.0	1.38
HPDSS 0910A	HPDCS 0910A	9.1	10.0	89.0	47.0	35.0	1.40
HPDSS 0920A	HPDCS 0920A	9.2	10.0	89.0	47.0	35.0	1.41
HPDSS 0930A	HPDCS 0930A	9.3	10.0	89.0	47.0	35.0	1.43
HPDSS 0940A	HPDCS 0940A	9.4	10.0	89.0	47.0	35.0	1.44
HPDSS 0950A	HPDCS 0950A	9.5	10.0	89.0	47.0	35.0	1.46
HPDSS 0960A	HPDCS 0960A	9.6	10.0	89.0	47.0	35.0	1.47
HPDSS 0970A	HPDCS 0970A	9.7	10.0	89.0	47.0	35.0	1.49
HPDSS 0980A	HPDCS 0980A	9.8	10.0	89.0	47.0	35.0	1.50
HPDSS 0990A	HPDCS 0990A	9.9	10.0	89.0	47.0	35.0	1.52
HPDSS 1000A	HPDCS 1000A	10.0	10.0	89.0	47.0	35.0	1.53
HPDSS 1010A	HPDCS 1010A	10.1	12.0	102.0	55.0	40.0	1.55
HPDSS 1020A	HPDCS 1020A	10.2	12.0	102.0	55.0	40.0	1.56
HPDSS 1030A	HPDCS 1030A	10.3	12.0	102.0	55.0	40.0	1.58
HPDSS 1040A	HPDCS 1040A	10.4	12.0	102.0	55.0	40.0	1.59
HPDSS 1050A	HPDCS 1050A	10.5	12.0	102.0	55.0	40.0	1.61
HPDSS 1060A	HPDCS 1060A	10.6	12.0	102.0	55.0	40.0	1.63
HPDSS 1070A	HPDCS 1070A	10.7	12.0	102.0	55.0	40.0	1.64
HPDSS 1080A	HPDCS 1080A	10.8	12.0	102.0	55.0	40.0	1.66
HPDSS 1090A	HPDCS 1090A	10.9	12.0	102.0	55.0	40.0	1.67
HPDSS 1100A	HPDCS 1100A	11.0	12.0	102.0	55.0	40.0	1.69
HPDSS 1110A	HPDCS 1110A	11.1	12.0	102.0	55.0	40.0	1.70
HPDSS 1120A	HPDCS 1120A	11.2	12.0	102.0	55.0	40.0	1.72
HPDSS 1130A	HPDCS 1130A	11.3	12.0	102.0	55.0	40.0	1.73
HPDSS 1140A	HPDCS 1140A	11.4	12.0	102.0	55.0	40.0	1.75
HPDSS 1150A	HPDCS 1150A	11.5	12.0	102.0	55.0	40.0	1.76
HPDSS 1160A	HPDCS 1160A	11.6	12.0	102.0	55.0	40.0	1.78
HPDSS 1170A	HPDCS 1170A	11.7	12.0	102.0	55.0	40.0	1.79

Twister® HPD Performance Drills - 3xD Series HPDSS, HPDCS

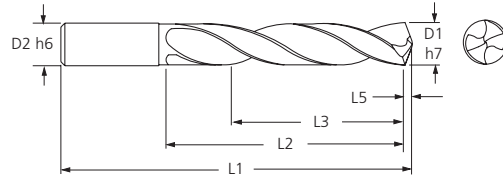
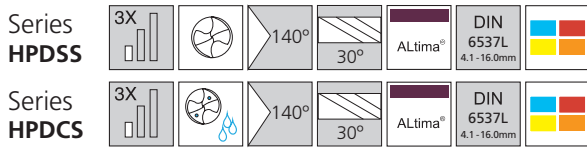

Series HPDSS	Series HPDCS	Tool Dimensions					
Tool No.	Tool No.	Ø D1	Ø D2	L1	L2 (Max.)	L3	L5
HPDSS 1180A	HPDCS 1180A	11.8	12.0	102.0	55.0	40.0	1.81
HPDSS 1190A	HPDCS 1190A	11.9	12.0	102.0	55.0	40.0	1.82
HPDSS 1200A	HPDCS 1200A	12.0	12.0	102.0	55.0	40.0	1.84
HPDSS 1210A	HPDCS 1210A	12.1	14.0	107.0	60.0	43.0	1.86
HPDSS 1220A	HPDCS 1220A	12.2	14.0	107.0	60.0	43.0	1.87
HPDSS 1230A	HPDCS 1230A	12.3	14.0	107.0	60.0	43.0	1.89
HPDSS 1240A	HPDCS 1240A	12.4	14.0	107.0	60.0	43.0	1.90
HPDSS 1250A	HPDCS 1250A	12.5	14.0	107.0	60.0	43.0	1.92
HPDSS 1260A	HPDCS 1260A	12.6	14.0	107.0	60.0	43.0	1.93
HPDSS 1270A	HPDCS 1270A	12.7	14.0	107.0	60.0	43.0	1.95
HPDSS 1280A	HPDCS 1280A	12.8	14.0	107.0	60.0	43.0	1.96
HPDSS 1290A	HPDCS 1290A	12.9	14.0	107.0	60.0	43.0	1.99
HPDSS 1300A	HPDCS 1300A	13.0	14.0	107.0	60.0	43.0	1.98
HPDSS 1310A	HPDCS 1310A	13.1	14.0	107.0	60.0	43.0	2.01
HPDSS 1320A	HPDCS 1320A	13.2	14.0	107.0	60.0	43.0	2.02
HPDSS 1330A	HPDCS 1330A	13.3	14.0	107.0	60.0	43.0	2.04
HPDSS 1340A	HPDCS 1340A	13.4	14.0	107.0	60.0	43.0	2.05
HPDSS 1350A	HPDCS 1350A	13.5	14.0	107.0	60.0	43.0	2.07
HPDSS 1360A	HPDCS 1360A	13.6	14.0	107.0	60.0	43.0	2.09
HPDSS 1370A	HPDCS 1370A	13.7	14.0	107.0	60.0	43.0	2.10
HPDSS 1380A	HPDCS 1380A	13.8	14.0	107.0	60.0	43.0	2.12
HPDSS 1390A	HPDCS 1390A	13.9	14.0	107.0	60.0	43.0	2.13
HPDSS 1400A	HPDCS 1400A	14.0	14.0	107.0	60.0	43.0	2.15
HPDSS 1410A	HPDCS 1410A	14.1	16.0	115.0	65.0	45.0	2.16
HPDSS 1420A	HPDCS 1420A	14.2	16.0	115.0	65.0	45.0	2.18
HPDSS 1430A	HPDCS 1430A	14.3	16.0	115.0	65.0	45.0	2.19
HPDSS 1440A	HPDCS 1440A	14.4	16.0	115.0	65.0	45.0	2.21
HPDSS 1450A	HPDCS 1450A	14.5	16.0	115.0	65.0	45.0	2.22
HPDSS 1460A	HPDCS 1460A	14.6	16.0	115.0	65.0	45.0	2.24
HPDSS 1470A	HPDCS 1470A	14.7	16.0	115.0	65.0	45.0	2.25
HPDSS 1480A	HPDCS 1480A	14.8	16.0	115.0	65.0	45.0	2.27
HPDSS 1490A	HPDCS 1490A	14.9	16.0	115.0	65.0	45.0	2.28
HPDSS 1500A	HPDCS 1500A	15.0	16.0	115.0	65.0	45.0	2.30
HPDSS 1510A	HPDCS 1510A	15.1	16.0	115.0	65.0	45.0	2.32
HPDSS 1520A	HPDCS 1520A	15.2	16.0	115.0	65.0	45.0	2.33
HPDSS 1530A	HPDCS 1530A	15.3	16.0	115.0	65.0	45.0	2.35
HPDSS 1540A	HPDCS 1540A	15.4	16.0	115.0	65.0	45.0	2.36
HPDSS 1550A	HPDCS 1550A	15.5	16.0	115.0	65.0	45.0	2.38
HPDSS 1560A	HPDCS 1560A	15.6	16.0	115.0	65.0	45.0	2.39
HPDSS 1570A	HPDCS 1570A	15.7	16.0	115.0	65.0	45.0	2.41
HPDSS 1580A	HPDCS 1580A	15.8	16.0	115.0	65.0	45.0	2.42
HPDSS 1590A	HPDCS 1590A	15.9	16.0	115.0	65.0	45.0	2.44
HPDSS 1600A	HPDCS 1600A	16.0	16.0	115.0	65.0	45.0	2.45



Twister® HPD Performance Drills - 5xD Series HPDSR, HPDCR

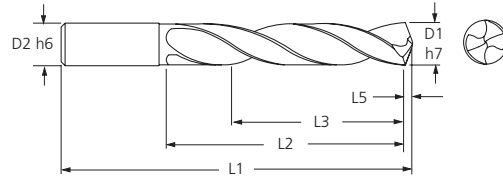
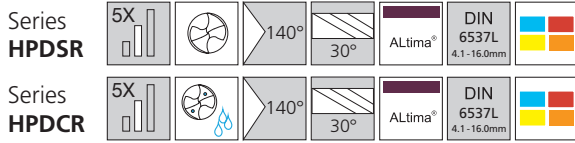

Series HPDSR	Series HPDCR	Tool Dimensions					
Tool No.	Tool No.	Ø D1	Ø D2	L1	L2 (Max.)	L3	L5
HPDSR 0300A	HPDCR 0300A	3.0	3.0	66.0	28.0	23.0	0.46
HPDSR 0310A	HPDCR 0310A	3.1	4.0	66.0	28.0	23.0	0.48
HPDSR 0320A	HPDCR 0320A	3.2	4.0	66.0	28.0	23.0	0.49
HPDSR 0330A	HPDCR 0330A	3.3	4.0	66.0	28.0	23.0	0.51
HPDSR 0340A	HPDCR 0340A	3.4	4.0	66.0	28.0	23.0	0.52
HPDSR 0350A	HPDCR 0350A	3.5	4.0	66.0	28.0	23.0	0.54
HPDSR 0360A	HPDCR 0360A	3.6	4.0	66.0	28.0	23.0	0.55
HPDSR 0370A	HPDCR 0370A	3.7	4.0	66.0	28.0	23.0	0.57
HPDSR 0380A	HPDCR 0380A	3.8	4.0	74.0	36.0	29.0	0.58
HPDSR 0390A	HPDCR 0390A	3.9	4.0	74.0	36.0	29.0	0.60
HPDSR 0400A	HPDCR 0400A	4.0	4.0	74.0	36.0	29.0	0.61
HPDSR 0410A	HPDCR 0410A	4.1	6.0	74.0	36.0	29.0	0.64
HPDSR 0420A	HPDCR 0420A	4.2	6.0	74.0	36.0	29.0	0.64
HPDSR 0430A	HPDCR 0430A	4.3	6.0	74.0	36.0	29.0	0.66
HPDSR 0440A	HPDCR 0440A	4.4	6.0	74.0	36.0	29.0	0.67
HPDSR 0450A	HPDCR 0450A	4.5	6.0	74.0	36.0	29.0	0.69
HPDSR 0460A	HPDCR 0460A	4.6	6.0	74.0	36.0	29.0	0.71
HPDSR 0470A	HPDCR 0470A	4.7	6.0	74.0	36.0	29.0	0.72
HPDSR 0480A	HPDCR 0480A	4.8	6.0	82.0	44.0	35.0	0.74
HPDSR 0490A	HPDCR 0490A	4.9	6.0	82.0	44.0	35.0	0.75
HPDSR 0500A	HPDCR 0500A	5.0	6.0	82.0	44.0	35.0	0.77
HPDSR 0510A	HPDCR 0510A	5.1	6.0	82.0	44.0	35.0	0.78
HPDSR 0520A	HPDCR 0520A	5.2	6.0	82.0	44.0	35.0	0.80
HPDSR 0530A	HPDCR 0530A	5.3	6.0	82.0	44.0	35.0	0.81
HPDSR 0540A	HPDCR 0540A	5.4	6.0	82.0	44.0	35.0	0.83
HPDSR 0550A	HPDCR 0550A	5.5	6.0	82.0	44.0	35.0	0.84
HPDSR 0560A	HPDCR 0560A	5.6	6.0	82.0	44.0	35.0	0.86
HPDSR 0570A	HPDCR 0570A	5.7	6.0	82.0	44.0	35.0	0.87
HPDSR 0580A	HPDCR 0580A	5.8	6.0	82.0	44.0	35.0	0.89
HPDSR 0590A	HPDCR 0590A	5.9	6.0	82.0	44.0	35.0	0.90
HPDSR 0600A	HPDCR 0600A	6.0	6.0	82.0	44.0	35.0	0.92
HPDSR 0610A	HPDCR 0610A	6.1	8.0	91.0	53.0	43.0	0.94
HPDSR 0620A	HPDCR 0620A	6.2	8.0	91.0	53.0	43.0	0.95
HPDSR 0630A	HPDCR 0630A	6.3	8.0	91.0	53.0	43.0	0.97
HPDSR 0640A	HPDCR 0640A	6.4	8.0	91.0	53.0	43.0	0.98
HPDSR 0650A	HPDCR 0650A	6.5	8.0	91.0	53.0	43.0	1.00
HPDSR 0660A	HPDCR 0660A	6.6	8.0	91.0	53.0	43.0	1.01
HPDSR 0670A	HPDCR 0670A	6.7	8.0	91.0	53.0	43.0	1.03
HPDSR 0680A	HPDCR 0680A	6.8	8.0	91.0	53.0	43.0	1.04
HPDSR 0690A	HPDCR 0690A	6.9	8.0	91.0	53.0	43.0	1.06
HPDSR 0700A	HPDCR 0700A	7.0	8.0	91.0	53.0	43.0	1.07
HPDSR 0710A	HPDCR 0710A	7.1	8.0	91.0	53.0	43.0	1.09
HPDSR 0720A	HPDCR 0720A	7.2	8.0	91.0	53.0	43.0	1.10

Twister® HPD Performance Drills - 5xD Series HPDSR, HPDCR

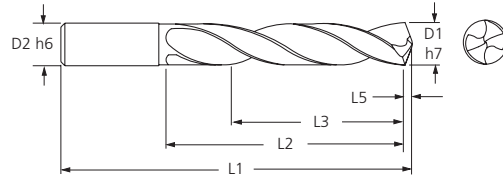
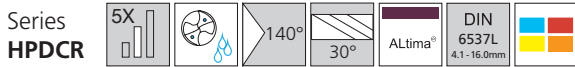
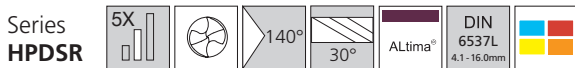

Series HPDSR	Series HPDCR	Tool Dimensions					
Tool No.	Tool No.	Ø D1	Ø D2	L1	L2 (Max.)	L3	L5
HPDSR 0730A	HPDCR 0730A	7.3	8.0	91.0	53.0	43.0	1.12
HPDSR 0740A	HPDCR 0740A	7.4	8.0	91.0	53.0	43.0	1.13
HPDSR 0750A	HPDCR 0750A	7.5	8.0	91.0	53.0	43.0	1.15
HPDSR 0760A	HPDCR 0760A	7.6	8.0	91.0	53.0	43.0	1.17
HPDSR 0770A	HPDCR 0770A	7.7	8.0	91.0	53.0	43.0	1.18
HPDSR 0780A	HPDCR 0780A	7.8	8.0	91.0	53.0	43.0	1.20
HPDSR 0790A	HPDCR 0790A	7.9	8.0	91.0	53.0	43.0	1.21
HPDSR 0800A	HPDCR 0800A	8.0	8.0	91.0	53.0	43.0	1.23
HPDSR 0810A	HPDCR 0810A	8.1	10.0	103.0	61.0	49.0	1.24
HPDSR 0820A	HPDCR 0820A	8.2	10.0	103.0	61.0	49.0	1.26
HPDSR 0830A	HPDCR 0830A	8.3	10.0	103.0	61.0	49.0	1.27
HPDSR 0840A	HPDCR 0840A	8.4	10.0	103.0	61.0	49.0	1.29
HPDSR 0850A	HPDCR 0850A	8.5	10.0	103.0	61.0	49.0	1.30
HPDSR 0860A	HPDCR 0860A	8.6	10.0	103.0	61.0	49.0	1.32
HPDSR 0870A	HPDCR 0870A	8.7	10.0	103.0	61.0	49.0	1.33
HPDSR 0880A	HPDCR 0880A	8.8	10.0	103.0	61.0	49.0	1.35
HPDSR 0890A	HPDCR 0890A	8.9	10.0	103.0	61.0	49.0	1.36
HPDSR 0900A	HPDCR 0900A	9.0	10.0	103.0	61.0	49.0	1.38
HPDSR 0910A	HPDCR 0910A	9.1	10.0	103.0	61.0	49.0	1.40
HPDSR 0920A	HPDCR 0920A	9.2	10.0	103.0	61.0	49.0	1.41
HPDSR 0930A	HPDCR 0930A	9.3	10.0	103.0	61.0	49.0	1.43
HPDSR 0940A	HPDCR 0940A	9.4	10.0	103.0	61.0	49.0	1.44
HPDSR 0950A	HPDCR 0950A	9.5	10.0	103.0	61.0	49.0	1.46
HPDSR 0960A	HPDCR 0960A	9.6	10.0	103.0	61.0	49.0	1.47
HPDSR 0970A	HPDCR 0970A	9.7	10.0	103.0	61.0	49.0	1.49
HPDSR 0980A	HPDCR 0980A	9.8	10.0	103.0	61.0	49.0	1.50
HPDSR 0990A	HPDCR 0990A	9.9	10.0	103.0	61.0	49.0	1.52
HPDSR 1000A	HPDCR 1000A	10.0	10.0	103.0	61.0	49.0	1.53
HPDSR 1010A	HPDCR 1010A	10.1	12.0	118.0	71.0	56.0	1.55
HPDSR 1020A	HPDCR 1020A	10.2	12.0	118.0	71.0	56.0	1.56
HPDSR 1030A	HPDCR 1030A	10.3	12.0	118.0	71.0	56.0	1.58
HPDSR 1040A	HPDCR 1040A	10.4	12.0	118.0	71.0	56.0	1.59
HPDSR 1050A	HPDCR 1050A	10.5	12.0	118.0	71.0	56.0	1.61
HPDSR 1060A	HPDCR 1060A	10.6	12.0	118.0	71.0	56.0	1.63
HPDSR 1070A	HPDCR 1070A	10.7	12.0	118.0	71.0	56.0	1.64
HPDSR 1080A	HPDCR 1080A	10.8	12.0	118.0	71.0	56.0	1.66
HPDSR 1090A	HPDCR 1090A	10.9	12.0	118.0	71.0	56.0	1.67
HPDSR 1100A	HPDCR 1100A	11.0	12.0	118.0	71.0	56.0	1.69
HPDSR 1110A	HPDCR 1110A	11.1	12.0	118.0	71.0	56.0	1.70
HPDSR 1120A	HPDCR 1120A	11.2	12.0	118.0	71.0	56.0	1.72
HPDSR 1130A	HPDCR 1130A	11.3	12.0	118.0	71.0	56.0	1.73
HPDSR 1140A	HPDCR 1140A	11.4	12.0	118.0	71.0	56.0	1.75
HPDSR 1150A	HPDCR 1150A	11.5	12.0	118.0	71.0	56.0	1.76
HPDSR 1160A	HPDCR 1160A	11.6	12.0	118.0	71.0	56.0	1.78



Twister® HPD Performance Drills - 5xD Series HPDSR, HPDCR

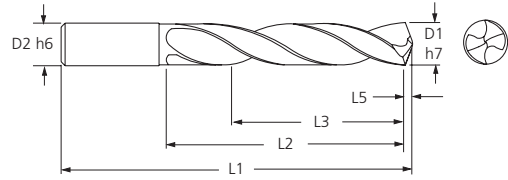
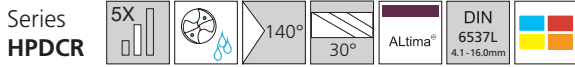
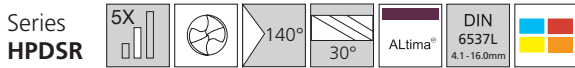

Series HPDSR	Series HPDCR	Tool Dimensions					
Tool No.	Tool No.	Ø D1	Ø D2	L1	L2 (Max.)	L3	L5
HPDSR 1170A	HPDCR 1170A	11.7	12.0	118.0	71.0	56.0	1.79
HPDSR 1180A	HPDCR 1180A	11.8	12.0	118.0	71.0	56.0	1.81
HPDSR 1190A	HPDCR 1190A	11.9	12.0	118.0	71.0	56.0	1.82
HPDSR 1200A	HPDCR 1200A	12.0	12.0	118.0	71.0	56.0	1.84
HPDSR 1210A	HPDCR 1210A	12.1	14.0	124.0	77.0	60.0	1.86
HPDSR 1220A	HPDCR 1220A	12.2	14.0	124.0	77.0	60.0	1.87
HPDSR 1230A	HPDCR 1230A	12.3	14.0	124.0	77.0	60.0	1.89
HPDSR 1240A	HPDCR 1240A	12.4	14.0	124.0	77.0	60.0	1.90
HPDSR 1250A	HPDCR 1250A	12.5	14.0	124.0	77.0	60.0	1.92
HPDSR 1260A	HPDCR 1260A	12.6	14.0	124.0	77.0	60.0	1.93
HPDSR 1270A	HPDCR 1270A	12.7	14.0	124.0	77.0	60.0	1.95
HPDSR 1280A	HPDCR 1280A	12.8	14.0	124.0	77.0	60.0	1.96
HPDSR 1290A	HPDCR 1290A	12.9	14.0	124.0	77.0	60.0	1.99
HPDSR 1300A	HPDCR 1300A	13.0	14.0	124.0	77.0	60.0	1.98
HPDSR 1310A	HPDCR 1310A	13.1	14.0	124.0	77.0	60.0	2.01
HPDSR 1320A	HPDCR 1320A	13.2	14.0	124.0	77.0	60.0	2.02
HPDSR 1330A	HPDCR 1330A	13.3	14.0	124.0	77.0	60.0	2.04
HPDSR 1340A	HPDCR 1340A	13.4	14.0	124.0	77.0	60.0	2.05
HPDSR 1350A	HPDCR 1350A	13.5	14.0	124.0	77.0	60.0	2.07
HPDSR 1360A	HPDCR 1360A	13.6	14.0	124.0	77.0	60.0	2.09
HPDSR 1370A	HPDCR 1370A	13.7	14.0	124.0	77.0	60.0	2.10
HPDSR 1380A	HPDCR 1380A	13.8	14.0	124.0	77.0	60.0	2.12
HPDSR 1390A	HPDCR 1390A	13.9	14.0	124.0	77.0	60.0	2.13
HPDSR 1400A	HPDCR 1400A	14.0	14.0	124.0	77.0	60.0	2.15
HPDSR 1410A	HPDCR 1410A	14.1	16.0	133.0	83.0	63.0	2.16
HPDSR 1420A	HPDCR 1420A	14.2	16.0	133.0	83.0	63.0	2.18
HPDSR 1430A	HPDCR 1430A	14.3	16.0	133.0	83.0	63.0	2.19
HPDSR 1440A	HPDCR 1440A	14.4	16.0	133.0	83.0	63.0	2.21
HPDSR 1450A	HPDCR 1450A	14.5	16.0	133.0	83.0	63.0	2.22
HPDSR 1460A	HPDCR 1460A	14.6	16.0	133.0	83.0	63.0	2.24
HPDSR 1470A	HPDCR 1470A	14.7	16.0	133.0	83.0	63.0	2.25
HPDSR 1480A	HPDCR 1480A	14.8	16.0	133.0	83.0	63.0	2.27
HPDSR 1490A	HPDCR 1490A	14.9	16.0	133.0	83.0	63.0	2.28
HPDSR 1500A	HPDCR 1500A	15.0	16.0	133.0	83.0	63.0	2.30
HPDSR 1510A	HPDCR 1510A	15.1	16.0	133.0	83.0	63.0	2.32
HPDSR 1520A	HPDCR 1520A	15.2	16.0	133.0	83.0	63.0	2.33
HPDSR 1530A	HPDCR 1530A	15.3	16.0	133.0	83.0	63.0	2.35
HPDSR 1540A	HPDCR 1540A	15.4	16.0	133.0	83.0	63.0	2.36
HPDSR 1550A	HPDCR 1550A	15.5	16.0	133.0	83.0	63.0	2.38
HPDSR 1560A	HPDCR 1560A	15.6	16.0	133.0	83.0	63.0	2.39
HPDSR 1570A	HPDCR 1570A	15.7	16.0	133.0	83.0	63.0	2.41
HPDSR 1580A	HPDCR 1580A	15.8	16.0	133.0	83.0	63.0	2.42
HPDSR 1590A	HPDCR 1590A	15.9	16.0	133.0	83.0	63.0	2.44
HPDSR 1600A	HPDCR 1600A	16.0	16.0	133.0	83.0	63.0	2.45



Twister® X-AL 3 Flute Performance Aluminium Drill - 4-5xD Series 229

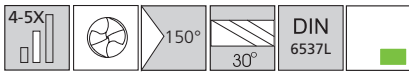

Series 229	Drill Dimensions				
Tool No.	Ø D1	Ø D2	L1	L2	L3
229 0200	2.0	2.0	38.0	16.0	12.0
229 0230	2.3	2.3	43.0	20.0	15.0
229 0250	2.5	2.5	43.0	20.0	15.0
229 0290	2.9	2.9	46.0	25.0	19.0
229 0300	3.0	6.0	66.0	28.0	23.0
229 0310	3.1	6.0	66.0	28.0	23.0
229 0320	3.2	6.0	66.0	28.0	23.0
229 0330	3.3	6.0	66.0	28.0	23.0
229 0340	3.4	6.0	66.0	28.0	23.0
229 0350	3.5	6.0	66.0	28.0	23.0
229 0360	3.6	6.0	66.0	28.0	23.0
229 0370	3.7	6.0	66.0	28.0	23.0
229 0380	3.8	6.0	74.0	36.0	29.0
229 0390	3.9	6.0	74.0	36.0	29.0
229 0400	4.0	6.0	74.0	36.0	29.0
229 0410	4.1	6.0	74.0	36.0	29.0
229 0420	4.2	6.0	74.0	36.0	29.0
229 0440	4.4	6.0	74.0	36.0	29.0
229 0450	4.5	6.0	74.0	36.0	29.0
229 0460	4.6	6.0	74.0	36.0	29.0
229 0480	4.8	6.0	82.0	44.0	35.0
229 0490	4.9	6.0	82.0	44.0	35.0
229 0500	5.0	6.0	82.0	44.0	35.0
229 0520	5.2	6.0	82.0	44.0	35.0
229 0550	5.5	6.0	82.0	44.0	35.0
229 0560	5.6	6.0	82.0	44.0	35.0
229 0600	6.0	6.0	82.0	44.0	35.0
229 0620	6.2	8.0	91.0	53.0	43.0
229 0650	6.5	8.0	91.0	53.0	43.0
229 0670	6.7	8.0	91.0	53.0	43.0
229 0680	6.8	8.0	91.0	53.0	43.0

Series 229	Drill Dimensions				
Tool No.	Ø D1	Ø D2	L1	L2	L3
229 0700	7.0	8.0	91.0	53.0	43.0
229 0720	7.2	8.0	91.0	53.0	43.0
229 0730	7.3	8.0	91.0	53.0	43.0
229 0740	7.4	8.0	91.0	53.0	43.0
229 0750	7.5	8.0	91.0	53.0	43.0
229 0780	7.8	8.0	91.0	53.0	43.0
229 0800	8.0	8.0	91.0	53.0	43.0
229 0810	8.1	10.0	103.0	61.0	49.0
229 0840	8.4	10.0	103.0	61.0	49.0
229 0850	8.5	10.0	103.0	61.0	49.0
229 0900	9.0	10.0	103.0	61.0	49.0
229 0950	9.5	10.0	103.0	61.0	49.0
229 0970	9.7	10.0	103.0	61.0	49.0
229 1000	10.0	10.0	103.0	61.0	49.0
229 1020	10.2	12.0	118.0	71.0	56.0
229 1040	10.4	12.0	118.0	71.0	56.0
229 1050	10.5	12.0	118.0	71.0	56.0
229 1060	10.6	12.0	118.0	71.0	56.0
229 1100	11.0	12.0	118.0	71.0	56.0
229 1150	11.5	12.0	118.0	71.0	56.0
229 1200	12.0	12.0	118.0	71.0	56.0
229 1250	12.5	14.0	124.0	77.0	60.0
229 1270	12.7	14.0	124.0	77.0	60.0
229 1300	13.0	14.0	124.0	77.0	60.0
229 1350	13.5	14.0	124.0	77.0	60.0
229 1400	14.0	14.0	124.0	77.0	60.0
229 1450	14.5	16.0	133.0	83.0	63.0
229 1500	15.0	16.0	133.0	83.0	63.0
229 1550	15.5	16.0	133.0	83.0	63.0
229 1580	15.8	16.0	133.0	83.0	63.0
229 1600	16.0	16.0	133.0	83.0	63.0



Twister® Hi-Tuff® Jobbers Drill - 5xD Series 224 Uncoated

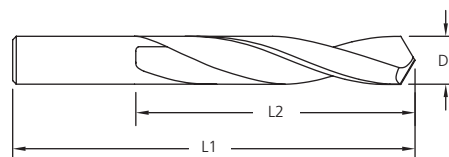

Series 224	Drill Dimensions		
Tool No	Ø D	L1	L2
224 0030	0.3	26.0	3.0
224 0035	0.35	26.0	4.0
224 0040	0.4	26.0	5.0
224 0045	0.45	26.0	5.0
224 0050	0.5	26.0	6.0
224 0055	0.55	26.0	7.0
224 0060	0.6	26.0	7.0
224 0065	0.65	26.0	8.0
224 0070	0.7	28.0	9.0
224 0075	0.75	28.0	9.0
224 0080	0.8	30.0	10.0
224 0085	0.85	30.0	10.0
224 0090	0.9	32.0	11.0
224 0095	0.95	32.0	11.0
224 0100	1.0	34.0	12.0
224 0105	1.05	34.0	12.0
224 0110	1.1	36.0	14.0
224 0115	1.15	36.0	14.0
224 0120	1.2	38.0	16.0
224 0125	1.25	38.0	16.0
224 0130	1.3	38.0	16.0
224 0135	1.35	40.0	18.0
224 0140	1.4	40.0	18.0
224 0145	1.45	40.0	18.0
224 0150	1.5	40.0	18.0
224 0160	1.6	43.0	20.0
224 0170	1.7	43.0	20.0
224 0180	1.8	46.0	22.0
224 0190	1.9	46.0	22.0
224 0200	2.0	49.0	24.0
224 0210	2.1	49.0	24.0
224 0220	2.2	53.0	27.0
224 0230	2.3	53.0	27.0
224 0240	2.4	57.0	30.0
224 0250	2.5	57.0	30.0
224 0260	2.6	57.0	30.0
224 0270	2.7	61.0	33.0
224 0280	2.8	61.0	33.0
224 0290	2.9	61.0	33.0
224 0300	3.0	61.0	33.0
224 0310	3.1	65.0	36.0
224 0320	3.2	65.0	36.0
224 0330	3.3	65.0	36.0
224 0340	3.4	70.0	39.0
224 0350	3.5	70.0	39.0

Series 224	Drill Dimensions		
Tool No	Ø D	L1	L2
224 0360	3.6	70.0	39.0
224 0370	3.7	70.0	39.0
224 0380	3.8	75.0	43.0
224 0390	3.9	75.0	43.0
224 0400	4.0	75.0	43.0
224 0410	4.1	75.0	43.0
224 0420	4.2	75.0	43.0
224 0430	4.3	80.0	47.0
224 0440	4.4	80.0	47.0
224 0450	4.5	80.0	47.0
224 0460	4.6	80.0	47.0
224 0470	4.7	80.0	47.0
224 0480	4.8	86.0	52.0
224 0490	4.9	86.0	52.0
224 0500	5.0	86.0	52.0
224 0510	5.1	86.0	52.0
224 0520	5.2	86.0	52.0
224 0530	5.3	86.0	52.0
224 0540	5.4	93.0	57.0
224 0550	5.5	93.0	57.0
224 0560	5.6	93.0	57.0
224 0570	5.7	93.0	57.0
224 0580	5.8	93.0	57.0
224 0590	5.9	93.0	57.0
224 0600	6.0	93.0	57.0
224 0610	6.1	101.0	63.0
224 0620	6.2	101.0	63.0
224 0630	6.3	101.0	63.0
224 0640	6.4	101.0	63.0
224 0650	6.5	101.0	63.0
224 0660	6.6	101.0	63.0
224 0670	6.7	101.0	63.0
224 0680	6.8	109.0	69.0
224 0690	6.9	109.0	69.0
224 0700	7.0	109.0	69.0
224 0710	7.1	109.0	69.0
224 0720	7.2	109.0	69.0
224 0730	7.3	109.0	69.0
224 0740	7.4	109.0	69.0
224 0750	7.5	109.0	69.0
224 0760	7.6	117.0	75.0
224 0770	7.7	117.0	75.0
224 0780	7.8	117.0	75.0
224 0790	7.9	117.0	75.0
224 0800	8.0	117.0	75.0

Twister® Hi-Tuff® Jobbers Drill - 5xD Series 224 Uncoated

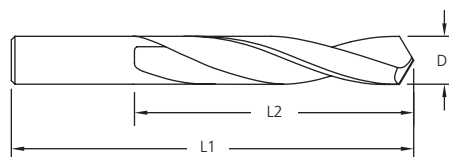

Series 224	Drill Dimensions		
Tool No	Ø D	L1	L2
224 0810	8.1	117.0	75.0
224 0820	8.2	117.0	75.0
224 0830	8.3	117.0	75.0
224 0840	8.4	117.0	75.0
224 0850	8.5	117.0	75.0
224 0860	8.6	125.0	81.0
224 0870	8.7	125.0	81.0
224 0880	8.8	125.0	81.0
224 0890	8.9	125.0	81.0
224 0900	9.0	125.0	81.0
224 0910	9.1	125.0	81.0
224 0920	9.2	125.0	81.0
224 0930	9.3	125.0	81.0
224 0940	9.4	125.0	81.0
224 0950	9.5	125.0	81.0
224 0960	9.6	133.0	87.0
224 0970	9.7	133.0	87.0
224 0980	9.8	133.0	87.0
224 0990	9.9	133.0	87.0
224 1000	10.0	133.0	87.0
224 1010	10.1	133.0	87.0
224 1020	10.2	133.0	87.0

Series 224	Drill Dimensions		
Tool No	Ø D	L1	L2
224 1030	10.3	133.0	160.0
224 1040	10.4	133.0	160.0
224 1050	10.5	133.0	160.0
224 1060	10.6	133.0	87.0
224 1070	10.7	142.0	94.0
224 1080	10.8	142.0	94.0
224 1090	10.9	142.0	94.0
224 1100	11.0	142.0	94.0
224 1110	11.1	142.0	94.0
224 1120	11.2	142.0	94.0
224 1130	11.3	142.0	94.0
224 1140	11.4	142.0	94.0
224 1150	11.5	142.0	94.0
224 1160	11.6	142.0	94.0
224 1170	11.7	142.0	94.0
224 1180	11.8	142.0	94.0
224 1190	11.9	151.0	101.0
224 1200	12.0	151.0	101.0
224 1250	12.5	151.0	101.0
224 1300	13.0	151.0	101.0
224 1350	13.5	160.0	108.0
224 1400	14.0	160.0	108.0



Twister® Centre Drill Series 402 Uncoated

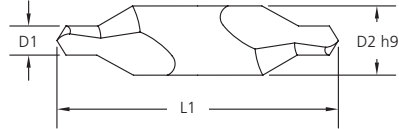

Series 402	Drill Dimensions		
Tool No	Ø D1	Ø D2	L1
402 0050	0.5	3.15	31.5*
402 0080	0.8	3.15	31.5*
402 0100	1.0	3.15	31.5
402 0125	1.25	3.15	31.5
402 0160	1.6	4.0	35.5
402 0200	2.0	5.0	40.0
402 0250	2.5	6.3	45.0
402 0315	3.15	8.0	50.0
402 0400	4.0	10.0	56.0
402 0500	5.0	12.5	63.0

* Overall Length (L1) Not To DIN Specification



Twister® 90° NC Spot Drill Series 404 Uncoated

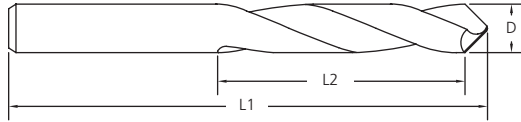
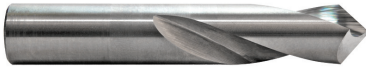
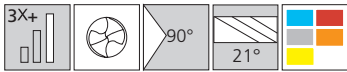

Series 404	Drill Dimensions		
Tool No	Ø D	L1	L2
404 0500	5.0	51.0	26.0
404 0600	6.0	51.0	26.0
404 0800	8.0	64.0	26.0
404 1000	10.0	70.0	30.0
404 1200	12.0	76.0	40.0



P183



FORDMAX

Drills
Forets
Bohrer
Punte
Wiertła

Twister® 120° NC Spot Drill Series 403 Uncoated

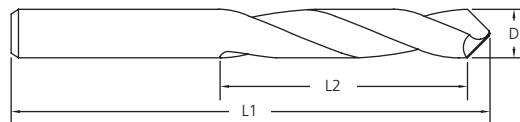
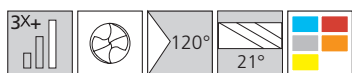

Series 403	Drill Dimensions		
Tool No	Ø D	L1	L2
403 0500	5.0	51.0	26.0
403 0600	6.0	51.0	26.0
403 0800	8.0	64.0	26.0
403 1000	10.0	70.0	30.0
403 1200	12.0	76.0	40.0



HSSCo Platinum Drills Series PRM-KSN Uncoated

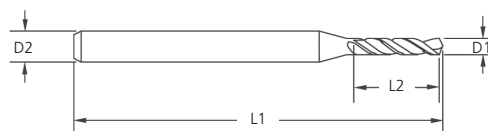
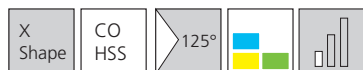

Series PRM-KSN	Tool Dimensions (mm)		
Tool No	D1	L1	L2
PRM-KS00030N	0.3	40.0	3.5
PRM-KS00040N	0.4	40.0	4.5
PRM-KS00050N	0.5	40.0	5.0
PRM-KS00060N	0.6	40.0	6.0
PRM-KS00070N	0.7	40.0	6.0
PRM-KS00080N	0.8	40.0	7.0
PRM-KS00090N	0.9	40.0	8.0



HSSCo Platinum Drills Series PRXS-KST

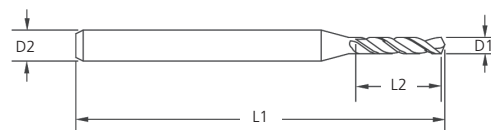

Series PRXS-KST	Tool Dimensions (mm)			
Tool No	Ø D1	Ø D2	L1	L2
PRXS-KS00100T	1.0	3.0	40.0	8.0
PRXS-KS00110T	1.1	3.0	40.0	10.0
PRXS-KS00120T	1.2	3.0	40.0	10.0
PRXS-KS00130T	1.3	3.0	40.0	11.0
PRXS-KS00140T	1.4	3.0	40.0	11.0
PRXS-KS00150T	1.5	3.0	40.0	12.0
PRXS-KS00160T	1.6	3.0	40.0	12.0
PRXS-KS00170T	1.7	3.0	40.0	12.0
PRXS-KS00180T	1.8	3.0	40.0	12.0
PRXS-KS00190T	1.9	3.0	40.0	12.0
PRXS-KS00200T	2.0	3.0	40.0	13.0
PRXS-KS00210T	2.1	3.0	40.0	13.0
PRXS-KS00220T	2.2	3.0	40.0	13.0
PRXS-KS00230T	2.3	3.0	40.0	13.0
PRXS-KS00240T	2.4	3.0	40.0	13.0
PRXS-KS00250T	2.5	3.0	40.0	13.0
PRXS-KS00260T	2.6	3.0	40.0	13.0
PRXS-KS00270T	2.7	3.0	40.0	16.0
PRXS-KS00280T	2.8	3.0	40.0	16.0
PRXS-KS00290T	2.9	3.0	40.0	16.0
PRXS-KS00300T	3.0	4.0	40.0	16.0
PRXS-KS00310T	3.1	4.0	50.0	18.0
PRXS-KS00320T	3.2	4.0	50.0	18.0
PRXS-KS00330T	3.3	4.0	50.0	18.0
PRXS-KS00340T	3.4	4.0	50.0	20.0
PRXS-KS00350T	3.5	4.0	50.0	20.0
PRXS-KS00360T	3.6	4.0	50.0	20.0
PRXS-KS00370T	3.7	4.0	50.0	20.0
PRXS-KS00380T	3.8	4.0	50.0	22.0
PRXS-KS00390T	3.9	4.0	50.0	22.0
PRXS-KS00400T	4.0	6.0	70.0	22.0
PRXS-KS00410T	4.1	6.0	70.0	22.0
PRXS-KS00420T	4.2	6.0	70.0	22.0
PRXS-KS00430T	4.3	6.0	70.0	22.0
PRXS-KS00440T	4.4	6.0	70.0	26.0
PRXS-KS00450T	4.5	6.0	70.0	26.0
PRXS-KS00460T	4.6	6.0	70.0	26.0
PRXS-KS00470T	4.7	6.0	70.0	26.0
PRXS-KS00480T	4.8	6.0	70.0	26.0
PRXS-KS00490T	4.9	6.0	70.0	26.0
PRXS-KS00500T	5.0	6.0	70.0	26.0
PRXS-KS00510T	5.1	6.0	70.0	26.0
PRXS-KS00520T	5.2	6.0	70.0	26.0
PRXS-KS00530T	5.3	6.0	70.0	26.0
PRXS-KS00540T	5.4	6.0	70.0	28.0
PRXS-KS00550T	5.5	6.0	70.0	28.0
PRXS-KS00560T	5.6	6.0	70.0	28.0
PRXS-KS00570T	5.7	6.0	70.0	28.0
PRXS-KS00580T	5.8	6.0	70.0	28.0

Series PRXS-KST	Tool Dimensions (mm)			
Tool No	Ø D1	Ø D2	L1	L2
PRXS-KS00590T	5.9	6.0	70.0	28.0
PRXS-KS00600T	6.0	8.0	80.0	31.0
PRXS-KS00610T	6.1	8.0	80.0	31.0
PRXS-KS00620T	6.2	8.0	80.0	31.0
PRXS-KS00630T	6.3	8.0	80.0	31.0
PRXS-KS00640T	6.4	8.0	80.0	31.0
PRXS-KS00650T	6.5	8.0	80.0	31.0
PRXS-KS00660T	6.6	8.0	80.0	31.0
PRXS-KS00670T	6.7	8.0	80.0	31.0
PRXS-KS00680T	6.8	8.0	80.0	34.0
PRXS-KS00690T	6.9	8.0	80.0	34.0
PRXS-KS00700T	7.0	8.0	80.0	34.0
PRXS-KS00710T	7.1	8.0	80.0	34.0
PRXS-KS00720T	7.2	8.0	80.0	34.0
PRXS-KS00730T	7.3	8.0	80.0	34.0
PRXS-KS00740T	7.4	8.0	80.0	34.0
PRXS-KS00750T	7.5	8.0	80.0	34.0
PRXS-KS00760T	7.6	8.0	80.0	37.0
PRXS-KS00770T	7.7	8.0	80.0	37.0
PRXS-KS00780T	7.8	8.0	80.0	37.0
PRXS-KS00790T	7.9	8.0	80.0	37.0
PRXS-KS00800T	8.0	10.0	90.0	37.0
PRXS-KS00810T	8.1	10.0	90.0	37.0
PRXS-KS00820T	8.2	10.0	90.0	37.0
PRXS-KS00830T	8.3	10.0	90.0	37.0
PRXS-KS00840T	8.4	10.0	90.0	37.0
PRXS-KS00850T	8.5	10.0	90.0	37.0
PRXS-KS00860T	8.6	10.0	90.0	40.0
PRXS-KS00870T	8.7	10.0	90.0	40.0
PRXS-KS00880T	8.8	10.0	90.0	40.0
PRXS-KS00890T	8.9	10.0	90.0	40.0
PRXS-KS00900T	9.0	10.0	90.0	40.0
PRXS-KS00910T	9.1	10.0	90.0	40.0
PRXS-KS00920T	9.2	10.0	90.0	40.0
PRXS-KS00930T	9.3	10.0	90.0	40.0
PRXS-KS00940T	9.4	10.0	90.0	40.0
PRXS-KS00950T	9.5	10.0	90.0	40.0
PRXS-KS00960T	9.6	10.0	90.0	43.0
PRXS-KS00970T	9.7	10.0	90.0	43.0
PRXS-KS00980T	9.8	10.0	90.0	43.0
PRXS-KS00990T	9.9	10.0	90.0	43.0
PRXS-KS01000T	10.0	12.0	100.0	43.0
PRXS-KS01010T	10.1	12.0	100.0	43.0
PRXS-KS01020T	10.2	12.0	100.0	43.0
PRXS-KS01030T	10.3	12.0	100.0	43.0
PRXS-KS01040T	10.4	12.0	100.0	43.0
PRXS-KS01050T	10.5	12.0	100.0	43.0
PRXS-KS01060T	10.6	12.0	100.0	43.0
PRXS-KS01070T	10.7	12.0	100.0	47.0



HSSCo Platinum Drills Series PRXS-KST

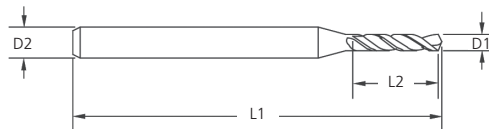

Series PRXS-KST	Tool Dimensions (mm)			
Tool No	Ø D1	Ø D2	L1	L2
PRXS-KS01080T	10.8	12.0	100.0	47.0
PRXS-KS01090T	10.9	12.0	100.0	47.0
PRXS-KS01100T	11.0	12.0	100.0	47.0
PRXS-KS01110T	11.1	12.0	100.0	47.0
PRXS-KS01120T	11.2	12.0	100.0	47.0
PRXS-KS01130T	11.3	12.0	100.0	47.0
PRXS-KS01140T	11.4	12.0	100.0	47.0
PRXS-KS01150T	11.5	12.0	100.0	47.0
PRXS-KS01160T	11.6	12.0	100.0	47.0
PRXS-KS01170T	11.7	12.0	100.0	47.0
PRXS-KS01180T	11.8	12.0	100.0	47.0

Series PRXS-KST	Tool Dimensions (mm)			
Tool No	Ø D1	Ø D2	L1	L2
PRXS-KS01190T	11.9	12.0	100.0	51.0
PRXS-KS01200T	12.0	12.0	100.0	51.0
PRXS-KS01210T	12.1	12.0	100.0	51.0
PRXS-KS01220T	12.2	12.0	100.0	51.0
PRXS-KS01230T	12.3	12.0	100.0	51.0
PRXS-KS01240T	12.4	12.0	100.0	51.0
PRXS-KS01250T	12.5	12.0	100.0	51.0
PRXS-KS01260T	12.6	12.0	100.0	51.0
PRXS-KS01270T	12.7	12.0	100.0	51.0
PRXS-KS01280T	12.8	12.0	100.0	51.0
PRXS-KS01290T	12.9	12.0	100.0	51.0
PRXS-KS01300T	13.0	12.0	100.0	51.0



HSSCo Platinum Drills Series PRXS-KMT

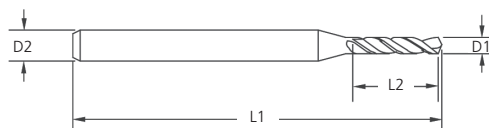

Series PRXS-MST	Tool Dimensions (mm)			
Tool No	Ø D1	Ø D2	L1	L2
PRXS-KM00100T	1.0	3.0	55.0	16.0
PRXS-KM00110T	1.1	3.0	55.0	18.0
PRXS-KM00120T	1.2	3.0	55.0	18.0
PRXS-KM00130T	1.3	3.0	55.0	20.0
PRXS-KM00140T	1.4	3.0	55.0	21.0
PRXS-KM00150T	1.5	3.0	55.0	21.0
PRXS-KM00160T	1.6	3.0	55.0	22.0
PRXS-KM00170T	1.7	3.0	55.0	22.0
PRXS-KM00180T	1.8	3.0	55.0	23.0
PRXS-KM00190T	1.9	3.0	55.0	23.0
PRXS-KM00200T	2.0	3.0	55.0	24.0
PRXS-KM00210T	2.1	3.0	55.0	24.0
PRXS-KM00220T	2.2	3.0	55.0	27.0
PRXS-KM00230T	2.3	3.0	55.0	27.0
PRXS-KM00240T	2.4	3.0	55.0	30.0
PRXS-KM00250T	2.5	3.0	55.0	30.0

Series PRXS-MST	Tool Dimensions (mm)			
Tool No	Ø D1	Ø D2	L1	L2
PRXS-KM00260T	2.6	3.0	55.0	30.0
PRXS-KM00270T	2.7	3.0	55.0	33.0
PRXS-KM00280T	2.8	3.0	55.0	33.0
PRXS-KM00290T	2.9	3.0	55.0	33.0
PRXS-KM00300T	3.0	4.0	70.0	33.0
PRXS-KM00310T	3.1	4.0	70.0	36.0
PRXS-KM00320T	3.2	4.0	70.0	36.0
PRXS-KM00330T	3.3	4.0	70.0	36.0
PRXS-KM00340T	3.4	4.0	70.0	39.0
PRXS-KM00350T	3.5	4.0	70.0	39.0
PRXS-KM00360T	3.6	4.0	70.0	39.0
PRXS-KM00370T	3.7	4.0	70.0	39.0
PRXS-KM00380T	3.8	4.0	70.0	43.0
PRXS-KM00390T	3.9	4.0	70.0	43.0
PRXS-KM00400T	4.0	6.0	90.0	43.0
PRXS-KM00410T	4.1	6.0	90.0	43.0

HSSCo Platinum Drills Series PRXS-KMT

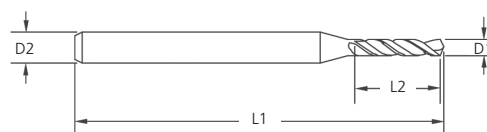

Series PRXS-MST	Tool Dimensions (mm)			
Tool No	Ø D1	Ø D2	L1	L2
PRXS-KM00420T	4.2	6.0	90.0	43.0
PRXS-KM00430T	4.3	6.0	90.0	47.0
PRXS-KM00440T	4.4	6.0	90.0	47.0
PRXS-KM00450T	4.5	6.0	90.0	47.0
PRXS-KM00460T	4.6	6.0	90.0	47.0
PRXS-KM00470T	4.7	6.0	90.0	47.0
PRXS-KM00480T	4.8	6.0	90.0	52.0
PRXS-KM00490T	4.9	6.0	90.0	52.0
PRXS-KM00500T	5.0	6.0	90.0	52.0
PRXS-KM00510T	5.1	6.0	90.0	52.0
PRXS-KM00520T	5.2	6.0	90.0	52.0
PRXS-KM00530T	5.3	6.0	90.0	52.0
PRXS-KM00540T	5.4	6.0	90.0	57.0
PRXS-KM00550T	5.5	6.0	90.0	57.0
PRXS-KM00560T	5.6	6.0	90.0	57.0
PRXS-KM00570T	5.7	6.0	90.0	57.0
PRXS-KM00580T	5.8	6.0	90.0	57.0
PRXS-KM00590T	5.9	6.0	90.0	57.0
PRXS-KM00600T	6.0	8.0	110.0	63.0
PRXS-KM00610T	6.1	8.0	110.0	63.0
PRXS-KM00620T	6.2	8.0	110.0	63.0
PRXS-KM00630T	6.3	8.0	110.0	63.0
PRXS-KM00640T	6.4	8.0	110.0	63.0
PRXS-KM00650T	6.5	8.0	110.0	63.0
PRXS-KM00660T	6.6	8.0	110.0	63.0
PRXS-KM00670T	6.7	8.0	110.0	69.0
PRXS-KM00680T	6.8	8.0	110.0	69.0
PRXS-KM00690T	6.9	8.0	110.0	69.0
PRXS-KM00700T	7.0	8.0	110.0	69.0
PRXS-KM00710T	7.1	8.0	110.0	69.0
PRXS-KM00720T	7.2	8.0	110.0	69.0
PRXS-KM00730T	7.3	8.0	110.0	69.0
PRXS-KM00740T	7.4	8.0	110.0	69.0
PRXS-KM00750T	7.5	8.0	110.0	69.0
PRXS-KM00760T	7.6	8.0	110.0	75.0
PRXS-KM00770T	7.7	8.0	110.0	75.0
PRXS-KM00780T	7.8	8.0	110.0	75.0
PRXS-KM00790T	7.9	8.0	110.0	75.0
PRXS-KM00800T	8.0	10.0	130.0	75.0
PRXS-KM00810T	8.1	10.0	130.0	75.0
PRXS-KM00820T	8.2	10.0	130.0	75.0
PRXS-KM00830T	8.3	10.0	130.0	75.0
PRXS-KM00840T	8.4	10.0	130.0	75.0
PRXS-KM00850T	8.5	10.0	130.0	75.0
PRXS-KM00860T	8.6	10.0	130.0	81.0

Series PRXS-MST	Tool Dimensions (mm)			
Tool No	Ø D1	Ø D2	L1	L2
PRXS-KM00870T	8.7	10.0	130.0	81.0
PRXS-KM00880T	8.8	10.0	130.0	81.0
PRXS-KM00890T	8.9	10.0	130.0	81.0
PRXS-KM00900T	9.0	10.0	130.0	81.0
PRXS-KM00910T	9.1	10.0	130.0	81.0
PRXS-KM00920T	9.2	10.0	130.0	81.0
PRXS-KM00930T	9.3	10.0	130.0	81.0
PRXS-KM00940T	9.4	10.0	130.0	81.0
PRXS-KM00950T	9.5	10.0	130.0	81.0
PRXS-KM00960T	9.6	10.0	130.0	81.0
PRXS-KM00970T	9.7	10.0	130.0	81.0
PRXS-KM00980T	9.8	10.0	130.0	81.0
PRXS-KM00990T	9.9	10.0	130.0	81.0
PRXS-KM01000T	10.0	12.0	150.0	87.0
PRXS-KM01010T	10.1	12.0	150.0	87.0
PRXS-KM01020T	10.2	12.0	150.0	87.0
PRXS-KM01030T	10.3	12.0	150.0	87.0
PRXS-KM01040T	10.4	12.0	150.0	87.0
PRXS-KM01050T	10.5	12.0	150.0	87.0
PRXS-KM01060T	10.6	12.0	150.0	87.0
PRXS-KM01070T	10.7	12.0	150.0	94.0
PRXS-KM01080T	10.8	12.0	150.0	94.0
PRXS-KM01090T	10.9	12.0	150.0	94.0
PRXS-KM01100T	11.0	12.0	150.0	94.0
PRXS-KM01110T	11.1	12.0	150.0	94.0
PRXS-KM01120T	11.2	12.0	150.0	94.0
PRXS-KM01130T	11.3	12.0	150.0	94.0
PRXS-KM01140T	11.4	12.0	150.0	94.0
PRXS-KM01150T	11.5	12.0	150.0	94.0
PRXS-KM01160T	11.6	12.0	150.0	94.0
PRXS-KM01170T	11.7	12.0	150.0	94.0
PRXS-KM01180T	11.8	12.0	150.0	94.0
PRXS-KM01190T	11.9	12.0	150.0	100.0
PRXS-KM01200T	12.0	12.0	150.0	100.0
PRXS-KM01210T	12.1	12.0	150.0	100.0
PRXS-KM01220T	12.2	12.0	150.0	100.0
PRXS-KM01230T	12.3	12.0	150.0	100.0
PRXS-KM01240T	12.4	12.0	150.0	100.0
PRXS-KM01250T	12.5	12.0	150.0	100.0
PRXS-KM01260T	12.6	12.0	150.0	100.0
PRXS-KM01270T	12.7	12.0	150.0	100.0
PRXS-KM01280T	12.8	12.0	150.0	100.0
PRXS-KM01290T	12.9	12.0	150.0	100.0
PRXS-KM01300T	13.0	12.0	150.0	100.0



Twister® High Performance GP Drills

Series HPDSS & HPDCS 3xD, Series HPDSR & HPDCR 5xD Recommended cutting data

Conditions de coupe recommandées · Empfohlene Schnittdaten · Dati di taglio raccomandati · Zalecane dane o cięciu (Zalacane parametry skrawania)

Workpiece Material Group	Material Type	HPDSS			HPDCS			
		3xD			3xD - Through Coolant			
		Low	Mid	High	Low	Mid	High	
		Vc-m/min			Vc-m/min			
Steels	P	Low Carbon Steels ≤180HB	140	160	180	170	190	210
		Med Carbon / Alloy Steels 180-350HB	80	90	100	90	110	130
		Pre-Hardened Steels 35-45HRC	40	50	60	60	70	80
Stainless Steels	M	Martensitic Stainless - 400 Series	90	100	110	100	120	140
		Austenitic Stainless - 300 Series	40	50	60	60	70	80
Cast Irons	K	Grey Cast Iron	100	120	140	130	150	170
		Ductile Cast Iron	50	60	70	70	80	90

 RPM Formula For Metric Drills - $RPM = (Vc \times 318) / \text{Drill } \varnothing D1$

Workpiece Material Group	Material Type	HPDSR			HPDCR			
		5xD			5xD - Through Coolant			
		Low	Mid	High	Low	Mid	High	
		Vc-m/min			Vc-m/min			
Steels	P	Low Carbon Steels ≤180HB	130	150	170	160	180	200
		Med Carbon / Alloy Steels 180-350HB	70	80	90	90	100	110
		Pre-Hardened Steels 35-45HRC	40	50	60	50	60	70
Stainless Steels	M	Martensitic Stainless - 400 Series	80	90	100	90	110	130
		Austenitic Stainless - 300 Series	40	50	60	50	60	70
Cast Irons	K	Grey Cast Iron	90	110	130	120	140	160
		Ductile Cast Iron	40	50	60	60	70	80

 RPM Formula For Metric Drills - $RPM = (Vc \times 318) / \text{Drill } \varnothing D1$

Workpiece Material Group	Material Type	Drill Diameter (mm)								
		3.0	4.0	5.0	6.0	8.0	10.0	12.0	16.0	
		Feed (mm/rev)								
Steels	P	Low Carbon Steels ≤180HB								
		Med Carbon / Alloy Steels 180-350HB	0.145	0.181	0.181	0.226	0.285	0.362	0.3632	0.453
		Pre-Hardened Steels 35-45HRC								
Stainless Steels	M	Martensitic Stainless - 400 Series	0.07	0.09	0.09	0.11	0.14	0.18	0.18	0.225
		Austenitic Stainless - 300 Series								
Cast Irons	K	Grey Cast Iron	0.155	0.193	0.217	0.305	0.305	0.386	0.435	0.532
		Ductile Cast Iron								

 Feedrate Formula For Metric Drills - $\text{Feed} = RPM \times \text{mm/rev}$

Twister® X-AL High Performance 3 Flute - 4-5xD

Series 229 Recommended cutting data

Conditions de coupe recommandées · Empfohlene Schnittdaten · Dati di taglio raccomandati · Zalecane dane o cięciu (Zalacane parametry skrawania)

Workpiece Material Groups	Example Materials	Vc (m/min)	Tool Diameter (mm)					
			1.5	3	6	12	20	25
			Feed (mm/rev)					
Titanium Alloys	Ti6Al4V	30	0.013	0.05	0.11	0.15	0.2	0.25
Aluminium < 10% Si	6061/7075	215	0.08	0.20	0.31	0.45	0.61	0.76
Aluminium > 10% Si	-	155	0.05	0.08	0.15	0.25	0.31	0.35
Brass/Copper	-	120	0.05	0.08	0.15	0.25	0.31	0.35
Plastics	-	90	0.05	0.08	0.15	0.25	0.31	0.35

 RPM Formula For Metric Drills Only - $RPM = (Vc \times 318.0) \div \text{Drill } \varnothing D1$

 Feedrate Formula For Metric Drills - $\text{Feed} = RPM \times \text{mm/rev}$

Twister® Micro Drill

Series 300 Recommended cutting data

Conditions de coupe recommandées :: Empfohlene Schnittdaten :: Dati di taglio raccomandati :: Zalecane dane o cięciu (Zalacane parametry skrawania)

Workpiece Material Groups	Examples	Vc (m/min)	Tool Diameter(mm)				
			0.5	1.0	2.0	3.0	
			Feed (mm/rev)				
Steels	P	Low Carbon Steels 1018	55	.0170	.0250	.0500	.0760
		Alloy Steels (up to 35 Rc) 4140	45	0170	.0250	.0500	.0760
Cast Irons	K	Gray Cast Iron A48 Class 20/G4000	85	0170	.0250	.0500	.0760
		Ductile Cast Iron A536/60-40-18	55	0170	.0250	.0500	.0760
Non-Ferrous	N	Aluminum (<10% Si) 6061-T6/7075-T6	120	0170	.0250	.0500	.0760
		Aluminum (>10% Si) Copper/Brass	75	0170	.0250	.0500	.0760
		Plastic	90	0170	.0250	.0500	.0760

RPM Formula For Metric Drills Only - $RPM = (Vc \times 318.0) \div \text{Drill } \varnothing D^1$

Feedrate Formula For Metric Drills - $\text{Feed} = RPM \times \text{mm/rev}$

Series 302 Recommended cutting data

Conditions de coupe recommandées :: Empfohlene Schnittdaten :: Dati di taglio raccomandati :: Zalecane dane o cięciu (Zalacane parametry skrawania)

Workpiece Material Groups	Examples	Vc (m/min)	Tool Diameter(mm)					
			< .76	.77-.92	.93-1.02	1.03-1.30	> 1.31	
			Feed (mm/rev)					
Steels	P	Low Carbon Steels 1018	90	.005-.015	0.02	0.025	0.036	0.038
		Alloy Steels (up to 35 Rc) 4140	70	.005-.015	0.02	0.025	0.036	0.038
		Alloy Steels (36-45 Rc) 4140	60	.005-.015	0.02	0.025	0.036	0.038
Austenitic	M	304/316	60	.005-.010	0.015	0.02	0.025	0.03
Stainless Steels		Free Machining	55	.005-.010	0.015	0.02	0.025	0.03
		Ferritic Martensitic	30	.005-.015	0.02	0.025	0.036	0.038
Precipitation Hardened Stainless Steels	17-4 PH	25	.005-.015	0.02	0.025	0.036	0.038	
Cast Irons	K	Gray Cast Iron A48 Class 20/G4000	120	.005-.015	0.02	0.025	0.036	0.038
		Ductile Cast Iron A536/60-40-18	110	.005-.015	0.02	0.025	0.036	0.038
Special Alloys	S	Titanium 6AL-4V	20	.005-.010	0.015	0.02	0.025	0.03
		High Temp Alloys Inconel/Hastelloy/Waspelloy	15	.005-.010	0.015	0.02	0.025	0.03
Hardened Steels	H	>45 Rc A2/52100	55	.005-.015	0.02	0.025	0.036	0.038
Non-Ferrous	N	Aluminum (<10% Si)	140	.005-.015	0.02	0.025	0.036	0.038
		Aluminum (>10% Si)	100	.005-.015	0.02	0.025	0.036	0.038
		Plastics	170	.005-.015	0.02	0.025	0.036	0.038
		Composites/Fiber Reinforced Materials/ Circuit Boards	200	.013-.038	0.051	0.076	0.102	0.127

RPM Formula For Metric Drills Only - $RPM = (Vc \times 318.0) \div \text{Drill } \varnothing D^1$

Feedrate Formula For Metric Drills - $\text{Feed} = RPM \times \text{mm/rev}$

Twister® Hi-Roc® Drill - 3xD

Series 200 Metric Recommended cutting data

Conditions de coupe recommandées · Empfohlene Schnittdaten · Dati di taglio raccomandati · Zalecane dane o cięciu (Zalacane parametry skrawania)

Workpiece Material Groups	Examples	Vc (m/min)	Tool Diameter (mm)								
			1.0	1.5	3.0	6.0	10.0	12.0	16.0	20.0	
			Feed (mm/rev)								
Steels	P	Low Carbon Steels 1018	55	.0060	.0130	.0510	.1020	.1270	.1520	.1750	.2030
		Alloy Steels (up to 35 Rc) 4140	45	.0060	.0130	.0510	.1020	.1270	.1520	.1750	.2030
		Alloy Steels (36-45 Rc) 4140	30	.0060	.0127	.0500	.0760	.1010	.1520	.2030	.2250
Austenitic	M	304/316	40	.0060	.0127	.0500	.0760	.1010	.1520	.2030	.2250
Precipitation Hardened Stainless Steels	M	17-4 PH	20	.0060	.0127	.0500	.0760	.1010	.1520	.2030	.2250
Special Alloys	S	Titanium 6AL-4V	25	.0060	.0127	.0500	.0760	.1010	.1520	.2030	.2250
		High Temp Alloys Inconel/Hastelloy/Waspelloy	25	.0060	.0127	.0500	.0760	.1010	.1520	.2030	.2250
Hardened Steels	H	>45 Rc A2/52100	20	.0130	.0250	.0250	.0250	.0500	.0500	.0500	.0760
Non-Ferrous	N	Plastic	90	.0060	.0127	.0500	.0760	.1010	.1520	.2030	.2250
		Kevlar/Graphite	115	.0060	.0127	.0500	.0760	.1010	.1520	.2030	.2250
		Glass/Ceramic	25	.0130	.0250	.0250	.0250	.0500	.0500	.0500	.0760

Twister® Series 205 207 224 Metric

Workpiece Material Groups	Examples	Series			
		205	207	224	
		Vc (m/min)			
Steels	P	Low Carbon Steels 1018	55	-	55
		Alloy Steels (up to 35 Rc) 4140	45	-	50
		Alloy Steels (36-45 Rc) 4140	35	-	45
Austenitic	M	304/316	45	-	40
Precipitation Hardened Stainless Steels	M	17-4 PH	20	-	-
Cast Irons	K	Gray Cast Iron A48 Class 20/G4000	55	-	85
		Ductile Cast Iron A536/60-40-18	55	-	55
Special Alloys	S	Titanium 6AL-4V	25	-	-
		High Temp Alloys Inconel/Hastelloy/Waspelloy	20	-	-
Hardened Steels	H	>45 Rc A2/52100	15	-	-
Non-Ferrous	N	Plastic	90	90	120
		Kevlar/Graphite	-	115	120

 RPM Formula For Metric Drills Only - $RPM = (Vc \times 318.0) \div \text{Drill } \varnothing D^1$

Twister® Series 205 207 224 Metric

Recommended cutting data · Conditions de coupe recommandées · Empfohlene Schnittdaten · Dati di taglio raccomandati

· Zalecane dane o cięciu (Zalacane parametry skrawania)

Workpiece Material Groups	Examples	Tool Diameter (mm)									
		1.0	1.5	3.0	6.0	10.0	12.0	16.0	20.0	26.0	
		Feed (mm/rev)									
Steels	P	Low Carbon Steels 1018	.0250	.0500	.0760	.1520	.2030	.2540	.2750	.3050	.3560
		Alloy Steels (up to 35 Rc) 4140	.0250	.0500	.0760	.1520	.2030	.2540	.2750	.3050	.3560
		Alloy Steels (36-45 Rc) 4140	.0250	.0500	.0760	.1520	.2030	.2540	.2750	.3050	.3560
Austenitic	M	304/316	.0250	.0500	.0760	.1520	.2030	.2540	.2750	.3050	.3560
Precipitation Hardened Stainless Steels		17-4 PH	.0060	.0127	.0500	.0760	.1010	.1520	.2030	.2250	.2540
Cast Irons	K	Gray Cast Iron A48 Class 20/G4000	.0250	.0500	.0760	.1520	.2030	.2540	.2750	.3050	.3560
		Ductile Cast Iron A536/60-40-18	.0250	.0500	.0760	.1520	.2030	.2540	.2750	.3050	.3560
Special Alloys	S	Titanium 6AL-4V	.0060	.0127	.0500	.0760	.1010	.1520	.2030	.2250	.2540
		High Temp Alloys Inconel/Hastelloy/Waspelloy	.0060	.0127	.0500	.0760	.1010	.1520	.2030	.2250	.2540
Hardened Steels	H	>45 Rc A2/52100	.0060	.0127	.0500	.0760	.1010	.1520	.2030	.2250	.2540
Non-Ferrous	N	Plastic	.0060	.0127	.0500	.0760	.1010	.1520	.2030	.2250	.2540
		Kevlar/Graphite	.0060	.0127	.0500	.0760	.1010	.1520	.2030	.2250	.2540

Feedrate Formula For Metric Drills - Feed = RPM x mm/rev

Twister® Series 402 403 404 Metric

Workpiece Material Groups	Examples	Vc (m/min)	Tool Diameter (mm)						
			1.0	1.5	3.0	6.0	10.0	12.0	
			Feed (mm/rev)						
Steels	P	Low Carbon Steels 1018	55	.0125	.0250	.0380	.0760	.1020	.1270
		Alloy Steels (up to 35 Rc) 4140	50	.0125	.0250	.0380	.0760	.1020	.1270
		Alloy Steels (36-45 Rc) 4140	45	.0125	.0250	.0380	.0760	.1020	.1270
Stainless Steels	M	304/316	40	.0125	.0250	.0380	.0760	.1020	.1270
		17-4 PH	20	.0125	.0250	.0380	.0760	.1020	.1270
Cast Irons	K	Gray Cast Iron A48 Class 20/G4000	85	.0125	.0250	.0380	.0760	.1020	.1270
		Ductile Cast Iron A536/60-40-18	55	.0125	.0250	.0380	.0760	.1020	.1270
Special Alloys	S	Titanium 6AL-4V	25	.0125	.0250	.0380	.0760	.1020	.1270
		High Temp Alloys Inconel/Hastelloy/Waspelloy	10	.0125	.0250	.0380	.0760	.1020	.1270
Hardened Steels	H	>45 Rc A2/52100	15	.0125	.0250	.0380	.0760	.1020	.1270

RPM Formula For Metric Drills Only - RPM = (Vc x 318.0) ÷ Drill Ø D¹

Feedrate Formula For Metric Drills - Feed = RPM x mm/rev

HSSCo Platinum Drills Recommended cutting data

Conditions de coupe recommandées · Empfohlene Schnittdaten · Dati di taglio raccomandati · Zalecane dane o cięciu (Zalacane parametry skrawania)



Precision Cut PRM-KSN Multi-Purpose, short length

 Coupe de précision PRM-KSN Multifonctions, courte longueur · Präzisionsschnitt PRM-KSN Mehrzweckwerkzeug, kurze Länge
 Taglio di precisione PRM-KSN Universale, tipo corto · Precyzyjne cięcie (wiercenie) PRM-KSN Uniwersalna, krótkie

Workpiece	Stainless Steel		Carbon Steel		Alloy Steel Tools Steel		Alloy Steel Die Steel		Copper Alloy		Aluminum alloy	
	SUS 420, 440, 316 (30-40 HRC)		SS400, S45C, FC (Up to 25 HRC)		SCM, SK (25-35 HRC)		SCM, SK (35-40 HRC)					
Diameter (mm)	rpm	mm/rev	rpm	mm/rev	rpm	mm/rev	rpm	mm/rev	rpm	mm/rev	rpm	mm/rev
0.3	12,000	0.01	20,000	0.01	19,000	0.01	15,000	0.01	20,000	0.01	20,000	0.01
0.4	9,500	0.01	16,000	0.01	14,000	0.01	11,000	0.01	16,000	0.02	20,000	0.02
0.5	7,700	0.02	13,000	0.02	12,000	0.02	9,000	0.01	12,500	0.03	20,000	0.03
0.6	6,400	0.02	11,000	0.02	10,000	0.02	7,400	0.02	10,500	0.03	20,000	0.04
0.7	5,500	0.03	9,000	0.03	8,800	0.03	6,400	0.02	9,000	0.04	18,000	0.05
0.8	4,400	0.03	8,000	0.04	7,700	0.03	5,600	0.03	8,000	0.04	16,000	0.05
0.9	4,200	0.04	7,600	0.04	6,800	0.03	5,000	0.03	7,500	0.04	15,500	0.06
1.0	4,000	0.04	7,200	0.05	6,200	0.04	4,500	0.03	7,000	0.05	15,500	0.06



Precision Cut PRXS-KST X Shape, for stainless steel drilling, short length

 Coupe de précision PRXS-KST Forme X, pour le perçage de l'acier inoxydable, courte longueur
 Präzisionsschnitt PRXS-KST X-Form, zum Bohren von rostfreiem Stahl, kurze Länge
 Taglio di precisione PRXS-KST Forma X, per foratura dell'acciaio inossidabile, tipo corto
 Precyzyjne wiertło PRXS-KST kształt X, do wiercenia w stali nierdzewnej, krótkie (krótka długość)

Precision Cut PRXS-KMT X Shape, for stainless steel drilling, medium length

 Coupe de précision PRXS-KMT Forme X, pour le perçage de l'acier inoxydable, longueur moyenne
 Präzisionsschnitt PRXS-KMT X-Form, zum Bohren von rostfreiem Stahl, mittlere Länge
 Taglio di precisione PRXS-KMT Forma X, per foratura dell'acciaio inossidabile, tipo medio
 Precyzyjne wiertło PRXS-KMT kształt X, do wiercenia w stali nierdzewnej, średni (średnia długość)

Workpiece	Stainless Steel								Steel		Brass & Copper Alloy		Aluminum Alloy	
	AISI SUS 304 SUS 316		AISI SUS 420 SUS 440		AISI SUS 430 SUS 330		AISI SUS 630 SUS 631		S45C S540		C1020 2600		A5052 ADC 12	
Diameter (mm)	rpm	mm/rev	rpm	mm/rev	rpm	mm/rev	rpm	mm/rev	rpm	mm/rev	rpm	mm/rev	rpm	mm/rev
2.0	2,700	0.06	2,800	0.09	3,000	0.09	1,600	0.04	5,500	0.09	4,500	0.09	9,000	0.09
3.0	1,800	0.08	1,900	0.13	2,000	0.13	1,100	0.05	3,700	0.13	2,800	0.13	2,800	0.13
4.0	1,350	0.10	1,400	0.15	1,500	0.15	800	0.07	2,800	0.15	2,200	0.15	2,200	0.15
5.0	1,080	0.12	1,200	0.18	1,300	0.18	650	0.09	2,200	0.18	1,800	0.18	1,800	0.18
6.0	900	0.15	950	0.19	1,000	0.19	550	0.10	1,800	0.19	1,400	0.19	1,400	0.19
8.0	680	0.19	720	0.20	800	0.20	400	0.14	1,400	0.20	1,100	0.20	1,100	0.20
10.0	540	0.21	570	0.22	600	0.22	320	0.18	1,100	0.22	900	0.22	900	0.22
12.0	450	0.23	480	0.25	500	0.25	280	0.19	930	0.25	710	0.25	710	0.25
13.0	420	0.25	440	0.26	450	0.26	250	0.20	880	0.26	660	0.26	660	0.26

* The rpm & mm/rev shall be 10% off for PRXS-KMT



In applications demanding precision hole tolerances, tighter diameter control and quality bore finishes, our TrueSize® reamers provide a high quality and highly cost-effective solution. Our reamers are available in a wide range of sizes and can be used to machine virtually any material, including cast iron, aluminium, stainless steel, exotic alloys, plastics and other non-ferrous materials.

(FR)

Pour les applications exigeant de la précision et une bonne tolérance de trous, un contrôle de diamètre plus strict et une finition de qualité dans le perçage, nos alésoirs TrueSize® fournissent des solutions de grande qualité et hautement rentables. Nos alésoirs sont disponibles dans une grande variété de tailles et peuvent être utilisés pour usiner pratiquement n'importe quel matériau, y compris la fonte, l'aluminium, l'acier inoxydable, les alliages exotiques, le plastique et d'autres matériaux non-ferreux.

(DE)

Für Anwendungen, bei denen Präzisionsbohrungen mit geringen Toleranzen, eine strengere Durchmesserkontrolle und eine hochwertige Oberflächengüte der Bohrungen erforderlich sind, bieten unsere TrueSize®-Reibahlen eine Lösung von hoher Qualität und zu einem sehr guten Preis-Leistungs-Verhältnis. Unsere Reibahlen sind in diversen Größen erhältlich und können zur Bearbeitung nahezu jeden Materials verwendet werden, einschließlich Gusseisen, Aluminium, rostfreiem Stahl, Sonderlegierungen, Kunststoffen und sonstigen eisenfreien Materialien.

(IT)

Nelle applicazioni che richiedono tolleranze di precisione per i fori, controllo più stretto del diametro e finiture di qualità, i nostri alesatori TrueSize® offrono una soluzione di alta qualità e altamente efficiente. I nostri alesatori sono disponibili in una vasta gamma di misure e possono essere utilizzati per la lavorazione di qualsiasi materiale, tra cui ghisa, alluminio, acciaio inossidabile, leghe esotiche, materie plastiche e altri materiali non ferrosi.

(PL)

W zastosowaniach wymagających precyzyjnych tolerancji otworów, dokładniejszej kontroli średnicy i wysokiej jakości wykończenia, nasze rozwiertaki TrueSize® zapewniają wysoką jakość i bardzo ekonomiczne rozwiązanie. Nasze rozwiertaki są dostępne w szerokiej gamie rozmiarów i mogą być stosowane do maszyn praktycznie w każdym materiale, w tym żeliwie, aluminium, stali nierdzewnej, stopach egzotycznych, tworzywach sztucznych i innych materiałach nieżelaznych.

TrueSize®

Reamers

Alésoirs Reibahlen Alesatori Rozwiertaki

	Page
TrueSize® Solid Carbide Reamers	186
Recommended Stock Allowance	
TrueSize® Straight Flute Carbide Reamers	187 -
Series 272	195
Technical Information	196



FORD MAX

Reamers
Alésoirs
Reibahlen
Alesatori
Rozwiertaki

TrueSize® Solid Carbide Reamers

Recommended Stock Allowance For Truesize® Solid Carbide Metric Reamers

Surépaisseur recommandée pour les alésoirs métriques en carbure monoblocs Truesize® · Empfohlenes Aufmaß für Truesize®-Vollhartmetall-Reibahlen
 Sovrametallo raccomandato per alesatori metrici in metallo duro Truesize® · Zalecany naddatek dla rozwiertaków węglkowych Truesize®

Workpiece Material Group	Material Type	Reamer Diameter (mm)										
		0.35	1.00	2.00	3.00	4.00	5.00	6.00	8.00	10.00	12.00	16.00
		Drill Diameter (mm)										
		0.30	0.90	1.80	2.70	3.70	4.70	5.70	7.60	9.60	11.60	15.50
Stock Allowance (mm)												
P	Low Carbon	0.03	0.09	0.17	0.24	0.26	0.27	0.28	0.31	0.33	0.35	0.41
	Medium Carbon	0.03	0.08	0.15	0.21	0.23	0.24	0.25	0.28	0.31	0.32	0.38
	Tool Steel	0.03	0.08	0.15	0.21	0.23	0.24	0.25	0.28	0.31	0.32	0.38
M	Stainless	0.03	0.08	0.15	0.21	0.23	0.24	0.25	0.28	0.31	0.32	0.38
S	High Temp Alloys	0.03	0.07	0.14	0.20	0.21	0.22	0.23	0.24	0.26	0.29	0.33
	Titanium Alloys	0.03	0.09	0.17	0.24	0.26	0.27	0.28	0.31	0.33	0.35	0.41
K	Grey Cast Iron	0.03	0.09	0.17	0.24	0.26	0.27	0.28	0.31	0.33	0.35	0.41
	Ductile Cast Iron	0.03	0.09	0.17	0.24	0.26	0.27	0.28	0.31	0.33	0.35	0.41
H	Hardened Steel	0.02	0.06	0.12	0.17	0.19	0.19	0.20	0.23	0.26	0.27	0.33
N	Aluminium Alloys	0.04	0.09	0.19	0.27	0.29	0.29	0.30	0.32	0.34	0.37	0.41
	Copper & Hard Bronze	0.04	0.09	0.19	0.27	0.29	0.29	0.30	0.33	0.36	0.38	0.43
	Brass & Soft Bronze	0.04	0.09	0.19	0.27	0.29	0.29	0.30	0.32	0.34	0.37	0.41

Dowel Pin Chart - Metric Dowels

Tableau des goupilles - goupilles métriques · Tabelle der Spannstifte - metrische Spannstifte · Tabella spine calibrate - Spine metriche · Tabela kołków - kołki metryczne

Dowel Pin	Strong Press Fit	Reamer Required	Tight Press Fit	Reamer Required	Loose Press Fit	Reamer Required	Tight Slip Fit	Reamer Required	Loose Slip Fit	Reamer Required
Size (mm)	Reamer Ø	Tool No.	Reamer Ø	Tool No.	Reamer Ø	Tool No.	Reamer Ø	Tool No.	Reamer Ø	Tool No.
2.0	1.95	27207670	1.98	27207810	1.99	27207850	2.01	27207900	2.02	27207950
3.0	2.95	27211610	2.98	27211750	3.00	27211800	3.01	27211850	3.02	27211900
4.0	3.95	27215550	3.99	27215700	4.00	27215750	4.01	27215800	4.03	27215850
5.0	4.95	27219490	4.99	27219650	5.00	27219690	5.02	27219750	5.03	27219800
6.0	5.95	27223430	5.98	27223550	5.99	27223600	6.01	27223650	6.02	27223700
8.0	7.95	27231300	7.98	27231400	8.00	27231500	8.00	27231500	8.03	27231600
10.0	9.96	27239200	9.98	27239300	10.00	27239370	10.01	27239400	10.03	27239500
12.0	11.96	27247100	11.99	27247200	12.00	27247240	12.01	27247300	12.01	27247300

Truesize® Reamer Tolerance - DIN 1420 H7

Dowels are to nominal size +0.0025 / -0.0025mm

ISO 9001:2008 Certified

ISO 9001:2008 Certifié
 Nach ISO 9001:2008 zertifiziert
 Certificato ISO 9001: 2008
 Certyfikat ISO 9001:2008

TrueSize® Straight Flute Carbide Reamers Series 272



DIN 1420 H7

D ¹ (mm)	Tolerance (mm)
≤ 3.00	+ 0.004 / + 0.008
> 3.00 - 6.00	+ 0.005 / + 0.010
> 6.00 - 10.00	+ 0.006 / + 0.012
> 10.00 - 16.00	+ 0.008 / + 0.015

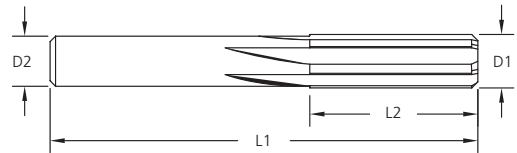

Tool No.	Tool Dimensions				
	Ø D1	Ø D2	L1	L2	Z
27201300	0.330	0.33	38.0	5.0	4
27201350	0.343	0.34	38.0	5.0	4
27201380	0.351	0.35	38.0	5.0	4
27201400	0.356	0.36	38.0	5.0	4
27201450	0.368	0.37	38.0	5.0	4
27201500	0.381	0.38	38.0	5.0	4
27201550	0.394	0.39	38.0	5.0	4
27201570	0.400	0.40	38.0	5.0	4
27201600	0.406	0.41	38.0	5.0	4
27201650	0.419	0.42	38.0	5.0	4
27201700	0.432	0.43	38.0	5.0	4
27201750	0.445	0.45	38.0	5.0	4
27201770	0.450	0.45	38.0	5.0	4
27201800	0.457	0.46	38.0	5.0	4
27201850	0.470	0.47	38.0	5.0	4
27201900	0.483	0.48	38.0	5.0	4
27201950	0.495	0.49	38.0	5.0	4
27201970	0.500	0.50	38.0	5.0	4
27202000	0.508	0.51	38.0	5.0	4
27202050	0.521	0.52	38.0	6.5	4
27202100	0.533	0.53	38.0	6.5	4
27202150	0.546	0.55	38.0	6.5	4
27202170	0.551	0.55	38.0	6.5	4
27202200	0.559	0.56	38.0	6.5	4
27202250	0.572	0.57	38.0	6.5	4
27202300	0.584	0.58	38.0	6.5	4
27202350	0.597	0.59	38.0	6.5	4
27202360	0.600	0.60	38.0	6.5	4
27202400	0.610	0.61	38.0	6.5	4
27202450	0.622	0.62	38.0	6.5	4
27202500	0.635	0.64	38.0	6.5	4
27202550	0.648	0.65	38.0	6.5	4
27202560	0.650	0.65	38.0	6.5	4
27202600	0.660	0.66	38.0	6.5	4
27202650	0.673	0.67	38.0	6.5	4
27202700	0.686	0.69	38.0	6.5	4
27202750	0.700	0.70	38.0	6.5	4
27202800	0.711	0.71	38.0	6.5	4
27202850	0.724	0.72	38.0	6.5	4
27202900	0.737	0.73	38.0	6.5	4
27202920	0.742	0.74	38.0	6.5	4
27202951	0.750	0.75	38.0	6.5	4
27203000	0.762	0.76	38.0	6.5	4
27203050	0.775	0.78	38.0	6.5	4
27203100	0.787	0.79	38.0	6.5	4
27203120	0.792	0.79	38.0	6.5	4
27203150	0.800	0.80	38.0	6.5	4

Tool No.	Tool Dimensions				
	Ø D1	Ø D2	L1	L2	Z
27203200	0.813	0.81	38.0	6.5	4
27203250	0.826	0.83	38.0	6.5	4
27203300	0.838	0.84	38.0	6.5	4
27203350	0.850	0.85	38.0	6.5	4
27203400	0.864	0.86	38.0	6.5	4
27203450	0.876	0.88	38.0	6.5	4
27203500	0.889	0.89	38.0	6.5	4
27203540	0.900	0.90	38.0	6.5	4
27203600	0.914	0.91	38.0	6.5	4
27203650	0.927	0.93	38.0	6.5	4
27203700	0.940	0.94	38.0	6.5	4
27203740	0.950	0.95	38.0	6.5	4
27203800	0.965	0.97	38.0	6.5	4
27203850	0.978	0.98	38.0	6.5	4
27203900	0.991	0.99	38.0	6.5	4
27203940	1.000	1.00	38.0	6.5	4
27204000	1.016	1.02	38.0	6.5	4
27204050	1.029	1.03	38.0	9.5	4
27204100	1.041	1.04	38.0	9.5	4
27204130	1.049	1.05	38.0	9.5	4
27204150	1.054	1.06	38.0	9.5	4
27204200	1.067	1.07	38.0	9.5	4
27204250	1.080	1.08	38.0	9.5	4
27204300	1.092	1.09	38.0	9.5	4
27204330	1.100	1.10	38.0	9.5	4
27204350	1.105	1.09	38.0	9.5	4
27204400	1.118	1.09	38.0	9.5	4
27204450	1.130	1.09	38.0	9.5	4
27204500	1.143	1.09	38.0	9.5	4
27204520	1.148	1.09	38.0	9.5	4
27204550	1.156	1.09	38.0	9.5	4
27204600	1.168	1.09	38.0	9.5	4
27204650	1.181	1.09	38.0	9.5	4
27204680	1.189	1.09	38.0	9.5	4
27204700	1.194	1.09	38.0	9.5	4
27204720	1.200	1.09	38.0	9.5	4
27204750	1.207	1.09	38.0	9.5	4
27204800	1.219	1.09	38.0	9.5	4
27204850	1.232	1.09	38.0	9.5	4
27204900	1.245	1.09	38.0	9.5	4
27204920	1.250	1.09	38.0	9.5	4
27204950	1.257	1.09	38.0	9.5	4
27205000	1.270	1.09	38.0	9.5	4
27205050	1.283	1.09	38.0	9.5	4
27205100	1.295	1.09	38.0	9.5	4
27205110	1.298	1.09	38.0	9.5	4
27205150	1.308	1.09	38.0	9.5	4



TrueSize® Straight Flute Carbide Reamers Series 272

DIN 1420 H7

D ¹ (mm)	Tolerance (mm)
≤ 3.00	+ 0.004 / + 0.008
> 3.00 - 6.00	+ 0.005 / + 0.010
> 6.00 - 10.00	+ 0.006 / + 0.012
> 10.00 - 16.00	+ 0.008 / + 0.015

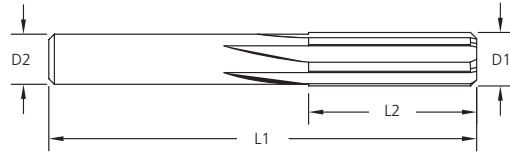

Tool No.	Tool Dimensions				
	Ø D1	Ø D2	L1	L2	Z
27205200	1.321	1.17	38.0	9.5	4
27205250	1.334	1.17	38.0	9.5	4
27205300	1.346	1.17	38.0	9.5	4
27205310	1.349	1.17	38.0	9.5	4
27205350	1.359	1.17	38.0	9.5	4
27205400	1.372	1.17	38.0	9.5	4
27205450	1.384	1.17	38.0	9.5	4
27205500	1.397	1.17	38.0	9.5	4
27205510	1.400	1.17	38.0	9.5	4
27205550	1.410	1.17	38.0	9.5	4
27205600	1.422	1.17	38.0	9.5	4
27205650	1.435	1.17	38.0	9.5	4
27205700	1.448	1.17	38.0	9.5	4
27205710	1.450	1.17	38.0	9.5	4
27205750	1.461	1.17	38.0	9.5	4
27205800	1.473	1.17	38.0	9.5	4
27205850	1.486	1.17	38.0	9.5	4
27205901	1.500	1.17	38.0	9.5	4
27205950	1.511	1.47	38.0	9.5	4
27206000	1.524	1.47	38.0	9.5	4
27206050	1.537	1.47	38.0	9.5	4
27206101	1.550	1.47	38.0	9.5	4
27206150	1.562	1.47	38.0	9.5	4
27206200	1.575	1.47	38.0	9.5	4
27206250	1.588	1.47	38.0	9.5	4
27206300	1.600	1.47	38.0	9.5	4
27206350	1.613	1.47	38.0	9.5	4
27206400	1.626	1.47	38.0	9.5	4
27206450	1.638	1.47	38.0	9.5	4
27206500	1.650	1.47	38.0	9.5	4
27206550	1.664	1.47	38.0	9.5	4
27206600	1.676	1.47	38.0	9.5	4
27206650	1.689	1.65	44.0	12.5	4
27206690	1.700	1.65	44.0	12.5	4
27206750	1.715	1.65	44.0	12.5	4
27206800	1.727	1.65	44.0	12.5	4
27206850	1.740	1.65	44.0	12.5	4
27206890	1.750	1.65	44.0	12.5	4
27206900	1.753	1.65	44.0	12.5	4
27206950	1.765	1.65	44.0	12.5	4
27207000	1.778	1.65	44.0	12.5	4
27207050	1.791	1.65	44.0	12.5	4
27207080	1.798	1.65	44.0	12.5	4
27207100	1.803	1.65	44.0	12.5	4
27207150	1.816	1.65	44.0	12.5	4
27207200	1.829	1.65	44.0	12.5	4
27207250	1.842	1.65	44.0	12.5	4

Tool No.	Tool Dimensions				
	Ø D1	Ø D2	L1	L2	Z
27207280	1.850	1.65	44.0	12.5	4
27207300	1.854	1.65	44.0	12.5	4
27207350	1.867	1.65	44.0	12.5	4
27207400	1.880	1.65	44.0	12.5	4
27207450	1.892	1.85	44.0	12.5	4
27207480	1.900	1.85	44.0	12.5	4
27207500	1.905	1.85	44.0	12.5	4
27207550	1.918	1.85	44.0	12.5	4
27207600	1.930	1.85	44.0	12.5	4
27207650	1.943	1.85	44.0	12.5	4
27207670	1.948	1.85	44.0	12.5	4
27207700	1.956	1.85	44.0	12.5	4
27207750	1.969	1.85	44.0	12.5	4
27207800	1.981	1.85	44.0	12.5	4
27207810	1.984	1.85	44.0	12.5	4
27207850	1.994	1.85	44.0	12.5	4
27207870	2.000	1.85	44.0	12.5	4
27207900	2.007	1.85	44.0	12.5	4
27207950	2.019	1.85	44.0	12.5	4
27208000	2.032	1.85	44.0	12.5	4
27208050	2.045	1.85	44.0	12.5	4
27208070	2.050	1.85	44.0	12.5	4
27208100	2.057	1.85	44.0	12.5	4
27208150	2.070	2.03	51.0	12.5	4
27208200	2.083	2.03	51.0	12.5	4
27208250	2.096	2.03	51.0	12.5	4
27208270	2.101	2.03	51.0	12.5	4
27208300	2.108	2.03	51.0	12.5	4
27208350	2.121	2.03	51.0	12.5	4
27208400	2.134	2.03	51.0	12.5	4
27208450	2.146	2.03	51.0	12.5	4
27208460	2.149	2.03	51.0	12.5	4
27208500	2.159	2.03	51.0	12.5	4
27208550	2.172	2.03	51.0	12.5	4
27208600	2.184	2.03	51.0	12.5	4
27208650	2.197	2.03	51.0	12.5	4
27208660	2.200	2.03	51.0	12.5	4
27208700	2.210	2.03	51.0	12.5	4
27208750	2.223	2.03	51.0	12.5	4
27208800	2.235	2.03	51.0	12.5	4
27208850	2.248	2.03	51.0	12.5	4
27208860	2.250	2.03	51.0	12.5	4
27208900	2.261	2.03	51.0	12.5	4
27208950	2.273	2.24	51.0	12.5	4
27209000	2.286	2.24	51.0	12.5	4
27209050	2.300	2.24	51.0	12.5	4
27209100	2.311	2.24	51.0	12.5	4

TrueSize® Straight Flute Carbide Reamers Series 272



DIN 1420 H7

D ¹ (mm)	Tolerance (mm)
≤ 3.00	+ 0.004 / + 0.008
> 3.00 - 6.00	+ 0.005 / + 0.010
> 6.00 - 10.00	+ 0.006 / + 0.012
> 10.00 - 16.00	+ 0.008 / + 0.015

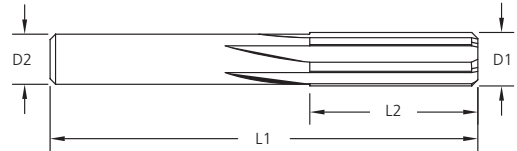

Tool No.	Tool Dimensions				
	Ø D1	Ø D2	L1	L2	Z
27209150	2.324	2.24	51.0	12.5	4
27209200	2.337	2.24	51.0	12.5	4
27209251	2.350	2.24	51.0	12.5	4
27209300	2.362	2.24	51.0	12.5	4
27209350	2.375	2.24	51.0	12.5	4
27209370	2.380	2.24	51.0	12.5	4
27209400	2.388	2.24	51.0	12.5	4
27209450	2.400	2.24	51.0	12.5	4
27209500	2.413	2.24	51.0	12.5	4
27209550	2.426	2.24	51.0	12.5	4
27209600	2.438	2.24	51.0	12.5	4
27209650	2.451	2.24	51.0	12.5	4
27209700	2.464	2.24	51.0	12.5	4
27209750	2.477	2.44	57.0	16.0	4
27209800	2.489	2.44	57.0	16.0	4
27209840	2.500	2.44	57.0	16.0	4
27209900	2.515	2.44	57.0	16.0	4
27209950	2.527	2.44	57.0	16.0	4
27210000	2.540	2.44	57.0	16.0	4
27210040	2.550	2.44	57.0	16.0	4
27210100	2.565	2.44	57.0	16.0	4
27210150	2.578	2.44	57.0	16.0	4
27210200	2.591	2.44	57.0	16.0	4
27210240	2.601	2.44	57.0	16.0	4
27210300	2.616	2.44	57.0	16.0	4
27210350	2.629	2.44	57.0	16.0	4
27210400	2.642	2.44	57.0	16.0	4
27210430	2.649	2.44	57.0	16.0	4
27210500	2.667	2.44	57.0	16.0	4
27210550	2.680	2.64	57.0	16.0	4
27210600	2.692	2.64	57.0	16.0	4
27210630	2.700	2.64	57.0	16.0	4
27210650	2.705	2.64	57.0	16.0	4
27210700	2.718	2.64	57.0	16.0	4
27210750	2.731	2.64	57.0	16.0	4
27210800	2.743	2.64	57.0	16.0	4
27210830	2.751	2.64	57.0	16.0	4
27210850	2.756	2.64	57.0	16.0	4
27210900	2.769	2.64	57.0	16.0	4
27210940	2.779	2.64	57.0	16.0	4
27210950	2.781	2.64	57.0	16.0	4
27211000	2.794	2.64	57.0	16.0	4
27211020	2.800	2.64	57.0	16.0	4
27211050	2.807	2.64	57.0	16.0	4
27211100	2.819	2.64	57.0	16.0	4
27211150	2.832	2.64	57.0	16.0	4
27211200	2.845	2.64	57.0	16.0	4

Tool No.	Tool Dimensions				
	Ø D1	Ø D2	L1	L2	Z
27211220	2.850	2.64	57.0	16.0	4
27211250	2.858	2.64	57.0	16.0	4
27211300	2.870	2.64	57.0	16.0	4
27211350	2.883	2.84	57.0	16.0	4
27211400	2.896	2.84	57.0	16.0	4
27211420	2.900	2.84	57.0	16.0	4
27211450	2.908	2.84	57.0	16.0	4
27211500	2.921	2.84	57.0	16.0	4
27211550	2.934	2.84	57.0	16.0	4
27211600	2.946	2.84	57.0	16.0	4
27211610	2.949	2.84	57.0	16.0	4
27211650	2.959	2.84	57.0	16.0	4
27211700	2.972	2.84	57.0	16.0	4
27211750	2.985	2.84	57.0	16.0	4
27211800	2.997	2.84	57.0	16.0	4
27211810	3.000	2.84	57.0	16.0	4
27211850	3.010	2.84	57.0	16.0	4
27211900	3.023	2.84	57.0	16.0	4
27211950	3.035	2.84	57.0	16.0	4
27212000	3.048	2.84	57.0	16.0	4
27212010	3.051	2.84	57.0	16.0	4
27212050	3.061	2.84	57.0	16.0	4
27212100	3.073	2.84	57.0	16.0	4
27212150	3.086	3.05	57.0	16.0	4
27212200	3.099	3.05	57.0	16.0	4
27212250	3.112	3.05	57.0	16.0	4
27212300	3.124	3.05	57.0	16.0	4
27212350	3.137	3.05	57.0	16.0	4
27212401	3.150	3.05	57.0	16.0	4
27212450	3.162	3.05	57.0	16.0	4
27212480	3.170	3.05	57.0	16.0	4
27212500	3.175	3.05	57.0	16.0	4
27212550	3.188	3.05	57.0	16.0	4
27212600	3.200	3.05	57.0	16.0	4
27212650	3.213	3.05	57.0	16.0	4
27212700	3.226	3.05	57.0	16.0	4
27212750	3.239	3.05	57.0	16.0	4
27212800	3.251	3.05	57.0	16.0	4
27212850	3.264	3.23	63.0	19.0	4
27212900	3.277	3.23	63.0	19.0	4
27212950	3.289	3.23	63.0	19.0	4
27212990	3.300	3.23	63.0	19.0	4
27213050	3.315	3.23	63.0	19.0	4
27213100	3.327	3.23	63.0	19.0	4
27213150	3.340	3.23	63.0	19.0	4
27213190	3.350	3.23	63.0	19.0	4
27213250	3.366	3.23	63.0	19.0	4
27213300	3.378	3.23	63.0	19.0	4



TrueSize® Straight Flute Carbide Reamers Series 272

DIN 1420 H7

D' (mm)	Tolerance (mm)
≤ 3.00	+ 0.004 / + 0.008
> 3.00 - 6.00	+ 0.005 / + 0.010
> 6.00 - 10.00	+ 0.006 / + 0.012
> 10.00 - 16.00	+ 0.008 / + 0.015

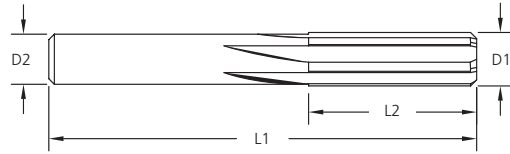

Tool No.	Tool Dimensions				
	Ø D1	Ø D2	L1	L2	Z
27213350	3.391	3.23	63.0	19.0	4
27213390	3.401	3.23	63.0	19.0	4
27213450	3.416	3.23	63.0	19.0	4
27213500	3.429	3.23	63.0	19.0	4
27213550	3.442	3.23	63.0	19.0	4
27213580	3.449	3.23	63.0	19.0	4
27213600	3.454	3.23	63.0	19.0	4
27213650	3.467	3.43	63.0	19.0	4
27213700	3.480	3.43	63.0	19.0	4
27213750	3.493	3.43	63.0	19.0	4
27213780	3.500	3.43	63.0	19.0	4
27213800	3.505	3.43	63.0	19.0	4
27213850	3.518	3.43	63.0	19.0	4
27213900	3.531	3.43	63.0	19.0	4
27213950	3.543	3.43	63.0	19.0	4
27213980	3.551	3.43	63.0	19.0	4
27214000	3.556	3.43	63.0	19.0	4
27214060	3.571	3.43	63.0	19.0	4
27214100	3.581	3.43	63.0	19.0	4
27214150	3.594	3.43	63.0	19.0	4
27214170	3.599	3.43	63.0	19.0	4
27214200	3.607	3.43	63.0	19.0	4
27214250	3.620	3.43	63.0	19.0	4
27214300	3.632	3.43	63.0	19.0	4
27214350	3.645	3.43	63.0	19.0	4
27214370	3.650	3.43	63.0	19.0	4
27214400	3.658	3.43	63.0	19.0	4
27214450	3.670	3.63	63.0	19.0	4
27214500	3.683	3.63	63.0	19.0	4
27214550	3.696	3.63	63.0	19.0	4
27214570	3.701	3.63	63.0	19.0	4
27214600	3.708	3.63	63.0	19.0	4
27214650	3.721	3.63	63.0	19.0	4
27214700	3.734	3.63	63.0	19.0	4
27214750	3.747	3.63	63.0	19.0	4
27214760	3.750	3.63	63.0	19.0	4
27214800	3.759	3.63	63.0	19.0	4
27214850	3.772	3.63	63.0	19.0	4
27214900	3.785	3.63	63.0	19.0	4
27214960	3.800	3.63	63.0	19.0	4
27215000	3.810	3.63	63.0	19.0	4
27215050	3.823	3.63	63.0	19.0	4
27215100	3.835	3.63	63.0	19.0	4
27215160	3.851	3.63	63.0	19.0	4
27215200	3.861	3.63	63.0	19.0	4
27215250	3.874	3.84	63.0	19.0	4
27215300	3.886	3.84	63.0	19.0	4

Tool No.	Tool Dimensions				
	Ø D1	Ø D2	L1	L2	Z
27215351	3.900	3.84	63.0	19.0	4
27215400	3.912	3.84	63.0	19.0	4
27215450	3.924	3.84	63.0	19.0	4
27215500	3.937	3.84	63.0	19.0	4
27215550	3.950	3.84	63.0	19.0	4
27215600	3.962	3.84	63.0	19.0	4
27215620	3.967	3.84	63.0	19.0	4
27215650	3.975	3.84	63.0	19.0	4
27215700	3.988	3.84	63.0	19.0	4
27215750	4.000	3.84	63.0	19.0	4
27215800	4.013	3.84	63.0	19.0	4
27215850	4.026	3.84	63.0	19.0	4
27215900	4.039	3.84	63.0	19.0	4
27215940	4.049	4.01	70.0	22.0	4
27216000	4.064	4.01	70.0	22.0	4
27216050	4.077	4.01	70.0	22.0	4
27216100	4.089	4.01	70.0	22.0	4
27216140	4.100	4.01	70.0	22.0	4
27216200	4.115	4.01	70.0	22.0	4
27216250	4.128	4.01	70.0	22.0	4
27216300	4.140	4.01	70.0	22.0	4
27216340	4.150	4.01	70.0	22.0	4
27216400	4.166	4.01	70.0	22.0	4
27216450	4.178	4.01	70.0	22.0	4
27216500	4.191	4.01	70.0	22.0	4
27216540	4.201	4.01	70.0	22.0	4
27216600	4.216	4.01	70.0	22.0	4
27216650	4.229	4.01	70.0	22.0	4
27216700	4.242	4.01	70.0	22.0	4
27216730	4.249	4.22	70.0	22.0	4
27216800	4.267	4.22	70.0	22.0	4
27216850	4.280	4.22	70.0	22.0	4
27216900	4.293	4.22	70.0	22.0	4
27216930	4.300	4.22	70.0	22.0	4
27216950	4.305	4.22	70.0	22.0	4
27217000	4.318	4.22	70.0	22.0	4
27217050	4.331	4.22	70.0	22.0	4
27217100	4.343	4.22	70.0	22.0	4
27217130	4.351	4.22	70.0	22.0	4
27217150	4.356	4.22	70.0	22.0	4
27217190	4.366	4.22	70.0	22.0	4
27217200	4.369	4.22	70.0	22.0	4
27217250	4.382	4.22	70.0	22.0	4
27217300	4.394	4.22	70.0	22.0	4
27217320	4.399	4.22	70.0	22.0	4
27217350	4.407	4.22	70.0	22.0	4
27217400	4.420	4.22	70.0	22.0	4

TrueSize® Straight Flute Carbide Reamers Series 272



DIN 1420 H7

D ¹ (mm)	Tolerance (mm)
≤ 3.00	+ 0.004 / + 0.008
> 3.00 - 6.00	+ 0.005 / + 0.010
> 6.00 - 10.00	+ 0.006 / + 0.012
> 10.00 - 16.00	+ 0.008 / + 0.015

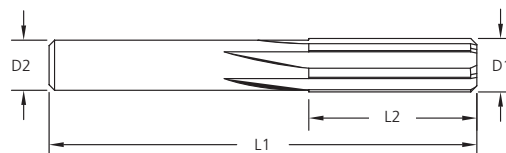

Tool No.	Tool Dimensions				
	Ø D1	Ø D2	L1	L2	Z
27217450	4.432	4.22	70.0	22.0	4
27217500	4.445	4.22	70.0	22.0	4
27217520	4.450	4.42	70.0	22.0	4
27217550	4.458	4.42	70.0	22.0	4
27217600	4.470	4.42	70.0	22.0	4
27217650	4.483	4.42	70.0	22.0	4
27217700	4.496	4.42	70.0	22.0	4
27217720	4.501	4.42	70.0	22.0	4
27217750	4.509	4.42	70.0	22.0	4
27217800	4.521	4.42	70.0	22.0	4
27217850	4.534	4.42	70.0	22.0	4
27217900	4.547	4.42	70.0	22.0	4
27217910	4.549	4.42	70.0	22.0	4
27217950	4.559	4.42	70.0	22.0	4
27218000	4.572	4.42	70.0	22.0	4
27218050	4.585	4.42	70.0	22.0	4
27218100	4.597	4.42	70.0	22.0	4
27218110	4.600	4.42	70.0	22.0	4
27218150	4.610	4.42	70.0	22.0	4
27218200	4.623	4.42	70.0	22.0	4
27218250	4.636	4.42	70.0	22.0	4
27218300	4.648	4.42	70.0	22.0	4
27218310	4.651	4.62	70.0	22.0	4
27218350	4.661	4.62	70.0	22.0	4
27218400	4.674	4.62	70.0	22.0	4
27218450	4.686	4.62	70.0	22.0	4
27218500	4.700	4.62	70.0	22.0	4
27218550	4.712	4.62	70.0	22.0	4
27218600	4.724	4.62	70.0	22.0	4
27218650	4.737	4.62	70.0	22.0	4
27218701	4.750	4.62	70.0	22.0	4
27218740	4.760	4.62	70.0	22.0	4
27218800	4.775	4.62	70.0	22.0	4
27218850	4.788	4.62	70.0	22.0	4
27218890	4.798	4.62	70.0	22.0	4
27218900	4.800	4.62	70.0	22.0	4
27218950	4.813	4.62	70.0	22.0	4
27219000	4.826	4.62	70.0	22.0	4
27219050	4.839	4.62	70.0	22.0	4
27219090	4.849	4.62	70.0	22.0	4
27219150	4.864	4.83	76.0	25.0	4
27219200	4.877	4.83	76.0	25.0	4
27219250	4.890	4.83	76.0	25.0	4
27219290	4.900	4.83	76.0	25.0	4
27219350	4.915	4.83	76.0	25.0	4
27219400	4.928	4.83	76.0	25.0	4
27219450	4.940	4.83	76.0	25.0	4

Tool No.	Tool Dimensions				
	Ø D1	Ø D2	L1	L2	Z
27219490	4.950	4.83	76.0	25.0	4
27219550	4.966	4.83	76.0	25.0	4
27219600	4.978	4.83	76.0	25.0	4
27219650	4.991	4.83	76.0	25.0	4
27219690	5.001	4.83	76.0	25.0	4
27219750	5.017	4.83	76.0	25.0	4
27219800	5.029	4.83	76.0	25.0	4
27219850	5.042	4.83	76.0	25.0	4
27219880	5.050	4.83	76.0	25.0	4
27219950	5.067	5.03	76.0	25.0	4
27220000	5.080	5.03	76.0	25.0	4
27220050	5.093	5.03	76.0	25.0	4
27220080	5.100	5.03	76.0	25.0	4
27220100	5.105	5.03	76.0	25.0	4
27220150	5.118	5.03	76.0	25.0	4
27220200	5.131	5.03	76.0	25.0	4
27220250	5.144	5.03	76.0	25.0	4
27220280	5.151	5.03	76.0	25.0	4
27220310	5.159	5.03	76.0	25.0	4
27220350	5.169	5.03	76.0	25.0	4
27220400	5.182	5.03	76.0	25.0	4
27220450	5.194	5.03	76.0	25.0	4
27220470	5.199	5.03	76.0	25.0	4
27220500	5.207	5.03	76.0	25.0	4
27220550	5.220	5.03	76.0	25.0	4
27220600	5.232	5.03	76.0	25.0	4
27220650	5.245	5.21	76.0	25.0	4
27220670	5.250	5.21	76.0	25.0	4
27220700	5.258	5.21	76.0	25.0	4
27220750	5.271	5.21	76.0	25.0	4
27220800	5.283	5.21	76.0	25.0	4
27220850	5.296	5.21	76.0	25.0	4
27220870	5.301	5.21	76.0	25.0	4
27220900	5.309	5.21	76.0	25.0	4
27220950	5.321	5.21	76.0	25.0	4
27221000	5.334	5.21	76.0	25.0	4
27221050	5.347	5.21	76.0	25.0	4
27221060	5.349	5.21	76.0	25.0	4
27221100	5.359	5.21	76.0	25.0	4
27221150	5.372	5.21	76.0	25.0	4
27221200	5.385	5.21	76.0	25.0	4
27221250	5.398	5.21	76.0	25.0	4
27221260	5.400	5.21	76.0	25.0	4
27221300	5.410	5.21	76.0	25.0	4
27221350	5.423	5.21	76.0	25.0	4
27221400	5.436	5.21	76.0	25.0	4
27221450	5.448	5.21	76.0	25.0	4



TrueSize® Straight Flute Carbide Reamers Series 272

DIN 1420 H7

D' (mm)	Tolerance (mm)
≤ 3.00	+ 0.004 / + 0.008
> 3.00 - 6.00	+ 0.005 / + 0.010
> 6.00 - 10.00	+ 0.006 / + 0.012
> 10.00 - 16.00	+ 0.008 / + 0.015

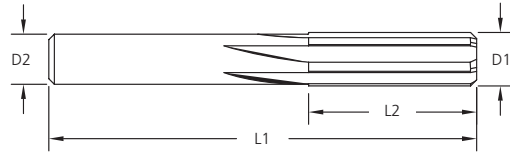

Tool No.	Tool Dimensions				
	Ø D1	Ø D2	L1	L2	Z
27221460	5.451	5.41	76.0	25.0	4
27221500	5.461	5.41	76.0	25.0	4
27221550	5.474	5.41	76.0	25.0	4
27221600	5.486	5.41	76.0	25.0	4
27221651	5.500	5.41	76.0	25.0	4
27221700	5.512	5.41	76.0	25.0	4
27221750	5.525	5.41	76.0	25.0	4
27221800	5.537	5.41	76.0	25.0	4
27221851	5.550	5.41	76.0	25.0	4
27221900	5.563	5.41	76.0	25.0	4
27221950	5.575	5.41	76.0	25.0	4
27222000	5.588	5.41	76.0	25.0	4
27222050	5.601	5.41	76.0	25.0	4
27222100	5.613	5.41	76.0	25.0	4
27222150	5.626	5.41	76.0	25.0	4
27222200	5.639	5.41	76.0	25.0	4
27222240	5.649	5.61	76.0	25.0	4
27222250	5.652	5.61	76.0	25.0	4
27222300	5.664	5.61	76.0	25.0	4
27222350	5.677	5.61	76.0	25.0	4
27222400	5.690	5.61	76.0	25.0	4
27222440	5.700	5.61	76.0	25.0	4
27222500	5.715	5.61	76.0	25.0	4
27222550	5.728	5.61	76.0	25.0	4
27222600	5.740	5.61	76.0	25.0	4
27222640	5.751	5.61	76.0	25.0	4
27222700	5.766	5.61	76.0	25.0	4
27222750	5.779	5.61	76.0	25.0	4
27222800	5.791	5.61	76.0	25.0	4
27222830	5.799	5.61	76.0	25.0	4
27222850	5.804	5.61	76.0	25.0	4
27222900	5.817	5.61	76.0	25.0	4
27222950	5.829	5.61	76.0	25.0	4
27223000	5.842	5.61	76.0	25.0	4
27223030	5.850	5.82	76.0	25.0	4
27223050	5.855	5.82	76.0	25.0	4
27223100	5.867	5.82	76.0	25.0	4
27223150	5.880	5.82	76.0	25.0	4
27223200	5.893	5.82	76.0	25.0	4
27223230	5.900	5.82	76.0	25.0	4
27223250	5.906	5.82	76.0	25.0	4
27223300	5.918	5.82	76.0	25.0	4
27223350	5.931	5.82	76.0	25.0	4
27223400	5.944	5.82	76.0	25.0	4
27223430	5.951	5.82	76.0	25.0	4
27223450	5.956	5.82	76.0	25.0	4
27223500	5.969	5.82	76.0	25.0	4

Tool No.	Tool Dimensions				
	Ø D1	Ø D2	L1	L2	Z
27223550	5.982	5.82	76.0	25.0	4
27223600	5.994	5.82	76.0	25.0	4
27223620	5.999	5.82	76.0	25.0	4
27223650	6.007	5.82	76.0	25.0	4
27223700	6.020	5.82	76.0	25.0	4
27223750	6.033	5.99	76.0	25.0	4
27223800	6.045	5.99	76.0	25.0	4
27223820	6.050	5.99	76.0	25.0	4
27223850	6.058	5.99	76.0	25.0	4
27223900	6.071	5.99	76.0	25.0	4
27223950	6.083	5.99	76.0	25.0	4
27224000	6.096	5.99	76.0	25.0	4
27224020	6.101	5.99	76.0	25.0	4
27224050	6.109	5.99	76.0	25.0	4
27224100	6.121	5.99	76.0	25.0	4
27224150	6.134	5.99	76.0	25.0	4
27224210	6.149	5.99	76.0	25.0	4
27224250	6.160	5.99	76.0	25.0	4
27224300	6.172	5.99	76.0	25.0	4
27224350	6.185	5.99	76.0	25.0	4
27224410	6.200	5.99	76.0	25.0	4
27224450	6.210	5.99	76.0	25.0	4
27224500	6.223	5.99	76.0	25.0	4
27224550	6.236	6.20	76.0	25.0	4
27224610	6.251	6.20	76.0	25.0	4
27224650	6.261	6.20	76.0	25.0	4
27224700	6.274	6.20	76.0	25.0	4
27224750	6.287	6.20	76.0	25.0	4
27224801	6.300	6.20	76.0	25.0	4
27224850	6.312	6.20	76.0	25.0	4
27224900	6.325	6.20	76.0	25.0	4
27224950	6.337	6.20	76.0	25.0	4
27224980	6.345	6.20	76.0	25.0	4
27225001	6.350	6.20	76.0	25.0	4
27225050	6.363	6.20	76.0	25.0	4
27225100	6.375	6.20	76.0	25.0	4
27225150	6.388	6.20	76.0	25.0	4
27225190	6.398	6.20	76.0	25.0	4
27225200	6.401	6.20	76.0	25.0	4
27225250	6.414	6.20	76.0	25.0	4
27225300	6.426	6.20	76.0	25.0	4
27225390	6.449	6.40	83.0	28.0	6
27225500	6.477	6.40	83.0	28.0	6
27225590	6.500	6.40	83.0	28.0	6
27225700	6.528	6.40	83.0	28.0	6
27225800	6.553	6.40	83.0	28.0	6
27225900	6.579	6.40	83.0	28.0	6

TrueSize® Straight Flute Carbide Reamers Series 272



DIN 1420 H7

D ¹ (mm)	Tolerance (mm)
≤ 3.00	+ 0.004 / + 0.008
> 3.00 - 6.00	+ 0.005 / + 0.010
> 6.00 - 10.00	+ 0.006 / + 0.012
> 10.00 - 16.00	+ 0.008 / + 0.015

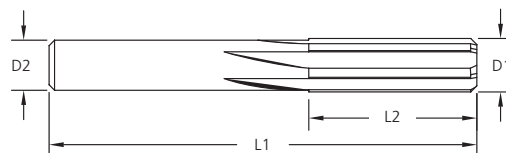

Tool No.	Tool Dimensions				
	Ø D1	Ø D2	L1	L2	Z
27226000	6.604	6.40	83.0	28.0	6
27226100	6.629	6.40	83.0	28.0	6
27226200	6.655	6.40	83.0	28.0	6
27226300	6.680	6.40	83.0	28.0	6
27226400	6.706	6.40	83.0	28.0	6
27226500	6.731	6.40	83.0	28.0	6
27226560	6.746	6.40	83.0	28.0	6
27226600	6.756	6.40	83.0	28.0	6
27226700	6.782	6.40	83.0	28.0	6
27226800	6.807	6.40	83.0	28.0	6
27226900	6.833	6.40	83.0	28.0	6
27227000	6.858	6.40	83.0	28.0	6
27227100	6.883	6.40	83.0	28.0	6
27227200	6.909	6.86	83.0	28.0	6
27227300	6.934	6.86	83.0	28.0	6
27227400	6.960	6.86	83.0	28.0	6
27227500	6.985	6.86	83.0	28.0	6
27227560	7.000	6.86	83.0	28.0	6
27227600	7.010	6.86	83.0	28.0	6
27227700	7.036	6.86	83.0	28.0	6
27227800	7.061	6.86	83.0	28.0	6
27227900	7.087	6.86	83.0	28.0	6
27228000	7.112	6.86	83.0	28.0	6
27228100	7.137	6.86	83.0	28.0	6
27228120	7.142	6.86	83.0	28.0	6
27228200	7.163	6.86	83.0	28.0	6
27228300	7.188	6.86	83.0	28.0	6
27228400	7.214	6.86	83.0	28.0	6
27228500	7.239	6.86	83.0	28.0	6
27228600	7.264	6.86	83.0	28.0	6
27228700	7.290	7.24	83.0	28.0	6
27228800	7.315	7.24	83.0	28.0	6
27228900	7.341	7.24	83.0	28.0	6
27229000	7.366	7.24	83.0	28.0	6
27229100	7.391	7.24	83.0	28.0	6
27229200	7.417	7.24	83.0	28.0	6
27229300	7.442	7.24	83.0	28.0	6
27229400	7.468	7.24	83.0	28.0	6
27229500	7.493	7.24	83.0	28.0	6
27229530	7.501	7.24	83.0	28.0	6
27229600	7.518	7.24	83.0	28.0	6
27229680	7.539	7.24	83.0	28.0	6
27229700	7.544	7.24	83.0	28.0	6
27229800	7.569	7.24	83.0	28.0	6
27229900	7.595	7.24	83.0	28.0	6
27230000	7.620	7.24	83.0	28.0	6
27230100	7.645	7.24	83.0	28.0	6

Tool No.	Tool Dimensions				
	Ø D1	Ø D2	L1	L2	Z
27230200	7.671	7.24	83.0	28.0	6
27230300	7.696	7.65	83.0	28.0	6
27230400	7.722	7.65	83.0	28.0	6
27230500	7.747	7.65	83.0	28.0	6
27230600	7.772	7.65	83.0	28.0	6
27230700	7.798	7.65	83.0	28.0	6
27230800	7.823	7.65	83.0	28.0	6
27230900	7.849	7.65	83.0	28.0	6
27231000	7.874	7.65	83.0	28.0	6
27231050	7.887	7.65	83.0	28.0	6
27231100	7.899	7.65	83.0	28.0	6
27231150	7.912	7.65	83.0	28.0	6
27231200	7.925	7.65	83.0	28.0	6
27231230	7.932	7.65	83.0	28.0	6
27231250	7.938	7.65	83.0	28.0	6
27231300	7.950	7.65	83.0	28.0	6
27231350	7.963	7.65	83.0	28.0	6
27231400	7.976	7.65	83.0	28.0	6
27231500	8.000	7.65	83.0	28.0	6
27231600	8.026	7.65	83.0	28.0	6
27231700	8.052	7.65	83.0	28.0	6
27231800	8.077	7.65	83.0	28.0	6
27231900	8.103	8.05	89.0	32.0	6
27232000	8.128	8.05	89.0	32.0	6
27232100	8.153	8.05	89.0	32.0	6
27232200	8.179	8.05	89.0	32.0	6
27232300	8.204	8.05	89.0	32.0	6
27232400	8.230	8.05	89.0	32.0	6
27232500	8.255	8.05	89.0	32.0	6
27232600	8.280	8.05	89.0	32.0	6
27232700	8.306	8.05	89.0	32.0	6
27232800	8.331	8.05	89.0	32.0	6
27232900	8.357	8.05	89.0	32.0	6
27233000	8.382	8.05	89.0	32.0	6
27233100	8.407	8.05	89.0	32.0	6
27233200	8.433	8.05	89.0	32.0	6
27233300	8.458	8.05	89.0	32.0	6
27233400	8.484	8.43	89.0	32.0	6
27233460	8.499	8.43	89.0	32.0	6
27233500	8.509	8.43	89.0	32.0	6
27233600	8.534	8.43	89.0	32.0	6
27233700	8.560	8.43	89.0	32.0	6
27233800	8.585	8.43	89.0	32.0	6
27233900	8.611	8.43	89.0	32.0	6
27234000	8.636	8.43	89.0	32.0	6
27234100	8.661	8.43	89.0	32.0	6
27234200	8.687	8.43	89.0	32.0	6



TrueSize® Straight Flute Carbide Reamers Series 272

DIN 1420 H7

D' (mm)	Tolerance (mm)
≤ 3.00	+ 0.004 / + 0.008
> 3.00 - 6.00	+ 0.005 / + 0.010
> 6.00 - 10.00	+ 0.006 / + 0.012
> 10.00 - 16.00	+ 0.008 / + 0.015

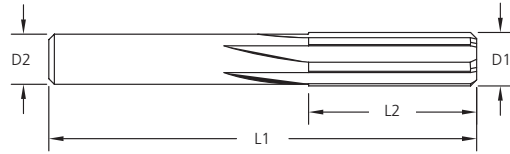

Tool No.	Tool Dimensions				
	Ø D1	Ø D2	L1	L2	Z
27234300	8.712	8.43	89.0	32.0	6
27234370	8.730	8.43	89.0	32.0	6
27234400	8.738	8.43	89.0	32.0	6
27234500	8.763	8.43	89.0	32.0	6
27234600	8.788	8.43	89.0	32.0	6
27234700	8.814	8.43	89.0	32.0	6
27234800	8.839	8.43	89.0	32.0	6
27234900	8.865	8.43	89.0	32.0	6
27235000	8.890	8.84	89.0	32.0	6
27235100	8.915	8.84	89.0	32.0	6
27235200	8.941	8.84	89.0	32.0	6
27235300	8.966	8.84	89.0	32.0	6
27235400	8.992	8.84	89.0	32.0	6
27235430	8.999	8.84	89.0	32.0	6
27235500	9.017	8.84	89.0	32.0	6
27235600	9.042	8.84	89.0	32.0	6
27235700	9.068	8.84	89.0	32.0	6
27235800	9.093	8.84	89.0	32.0	6
27235900	9.119	8.84	89.0	32.0	6
27235940	9.129	8.84	89.0	32.0	6
27236000	9.144	8.84	89.0	32.0	6
27236100	9.169	8.84	89.0	32.0	6
27236200	9.195	8.84	89.0	32.0	6
27236300	9.220	8.84	89.0	32.0	6
27236400	9.246	8.84	89.0	32.0	6
27236500	9.271	9.22	89.0	32.0	6
27236600	9.296	9.22	89.0	32.0	6
27236700	9.322	9.22	89.0	32.0	6
27236800	9.347	9.22	89.0	32.0	6
27236900	9.373	9.22	89.0	32.0	6
27237000	9.398	9.22	89.0	32.0	6
27237100	9.423	9.22	89.0	32.0	6
27237200	9.449	9.22	89.0	32.0	6
27237300	9.474	9.22	89.0	32.0	6
27237400	9.500	9.22	89.0	32.0	6
27237450	9.512	9.22	89.0	32.0	6
27237480	9.520	9.22	89.0	32.0	6
27237500	9.525	9.22	89.0	32.0	6
27237600	9.550	9.22	89.0	32.0	6
27237700	9.576	9.22	89.0	32.0	6
27237800	9.601	9.22	89.0	32.0	6
27237900	9.627	9.22	89.0	32.0	6
27238000	9.652	9.22	89.0	32.0	6
27238100	9.677	9.22	89.0	32.0	6
27238200	9.703	9.22	89.0	32.0	6
27238300	9.728	9.22	89.0	32.0	6
27238400	9.754	9.22	89.0	32.0	6

Tool No.	Tool Dimensions				
	Ø D1	Ø D2	L1	L2	Z
27238500	9.779	9.22	89.0	32.0	6
27238600	9.804	9.22	89.0	32.0	6
27238700	9.830	9.65	89.0	32.0	6
27238800	9.855	9.65	89.0	32.0	6
27238900	9.881	9.65	89.0	32.0	6
27239000	9.906	9.65	89.0	32.0	6
27239060	9.921	9.65	89.0	32.0	6
27239100	9.931	9.65	89.0	32.0	6
27239200	9.957	9.65	89.0	32.0	6
27239300	9.982	9.65	89.0	32.0	6
27239370	10.000	9.65	89.0	32.0	6
27239400	10.008	9.65	89.0	32.0	6
27239500	10.033	9.65	89.0	32.0	6
27239600	10.058	9.65	89.0	32.0	6
27239700	10.084	9.65	89.0	32.0	6
27239800	10.109	9.65	89.0	32.0	6
27239900	10.135	9.65	89.0	32.0	6
27240000	10.160	9.65	89.0	32.0	6
27240100	10.185	9.65	89.0	32.0	6
27240200	10.211	9.65	89.0	32.0	6
27240300	10.236	9.65	89.0	32.0	6
27240400	10.262	9.65	89.0	32.0	6
27240500	10.287	9.65	89.0	32.0	6
27240600	10.312	9.65	89.0	32.0	6
27240620	10.317	9.65	89.0	32.0	6
27240700	10.338	9.65	89.0	32.0	6
27240800	10.363	9.65	89.0	32.0	6
27240900	10.389	9.65	89.0	32.0	6
27241000	10.414	9.65	89.0	32.0	6
27241100	10.439	9.65	89.0	32.0	6
27241200	10.465	9.65	89.0	32.0	6
27241300	10.490	9.65	89.0	32.0	6
27241340	10.500	9.65	89.0	32.0	6
27241400	10.516	9.65	89.0	32.0	6
27241500	10.541	9.65	89.0	32.0	6
27241600	10.566	10.41	95.0	35.0	6
27241700	10.592	10.41	95.0	35.0	6
27241800	10.617	10.41	95.0	35.0	6
27241900	10.643	10.41	95.0	35.0	6
27242000	10.668	10.41	95.0	35.0	6
27242100	10.693	10.41	95.0	35.0	6
27242200	10.719	10.41	95.0	35.0	6
27242300	10.744	10.41	95.0	35.0	6
27242400	10.770	10.41	95.0	35.0	6
27242500	10.795	10.41	95.0	35.0	6
27242600	10.820	10.41	95.0	35.0	6
27242700	10.846	10.41	95.0	35.0	6

TrueSize® Straight Flute Carbide Reamers Series 272



DIN 1420 H7

D ¹ (mm)	Tolerance (mm)
≤ 3.00	+ 0.004 / + 0.008
> 3.00 - 6.00	+ 0.005 / + 0.010
> 6.00 - 10.00	+ 0.006 / + 0.012
> 10.00 - 16.00	+ 0.008 / + 0.015

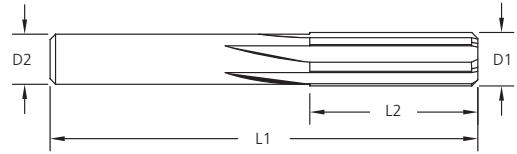

Tool No.	Tool Dimensions				
	Ø D1	Ø D2	L1	L2	Z
27242800	10.871	10.41	95.0	35.0	6
27242900	10.897	10.41	95.0	35.0	6
27243000	10.922	10.41	95.0	35.0	6
27243100	10.947	10.41	95.0	35.0	6
27243200	10.973	10.41	95.0	35.0	6
27243310	11.000	10.41	95.0	35.0	6
27243400	11.024	10.41	95.0	35.0	6
27243500	11.049	10.41	95.0	35.0	6
27243600	11.074	10.41	95.0	35.0	6
27243700	11.100	10.41	95.0	35.0	6
27243740	11.110	10.41	95.0	35.0	6
27243800	11.125	10.41	95.0	35.0	6
27243850	11.138	10.41	95.0	35.0	6
27243900	11.151	10.41	95.0	35.0	6
27244000	11.176	10.41	95.0	35.0	6
27244100	11.201	10.41	95.0	35.0	6
27244200	11.227	10.41	95.0	35.0	6
27244300	11.252	10.41	95.0	35.0	6
27244400	11.278	10.41	95.0	35.0	6
27244500	11.303	10.41	95.0	35.0	6
27244600	11.328	11.18	95.0	35.0	6
27244700	11.354	11.18	95.0	35.0	6
27244800	11.379	11.18	95.0	35.0	6
27244900	11.405	11.18	95.0	35.0	6
27245000	11.430	11.18	95.0	35.0	6
27245100	11.455	11.18	95.0	35.0	6
27245200	11.481	11.18	95.0	35.0	6
27245270	11.499	11.18	95.0	35.0	6
27245310	11.509	11.18	95.0	35.0	6
27245400	11.532	11.18	95.0	35.0	6
27245500	11.557	11.18	95.0	35.0	6
27245600	11.582	11.18	95.0	35.0	6
27245700	11.608	11.18	95.0	35.0	6
27245800	11.633	11.18	95.0	35.0	6
27245900	11.659	11.18	95.0	35.0	6
27246000	11.684	11.18	95.0	35.0	6
27246100	11.709	11.18	95.0	35.0	6
27246200	11.735	11.18	95.0	35.0	6
27246300	11.760	11.18	95.0	35.0	6
27246400	11.786	11.18	95.0	35.0	6
27246500	11.811	11.18	95.0	35.0	6
27246600	11.836	11.18	95.0	35.0	6
27246700	11.862	11.18	95.0	35.0	6
27246800	11.887	11.18	95.0	35.0	6
27246880	11.908	11.18	95.0	35.0	6
27246900	11.913	11.18	95.0	35.0	6
27247000	11.938	11.18	95.0	35.0	6

Tool No.	Tool Dimensions				
	Ø D1	Ø D2	L1	L2	Z
27247100	11.963	11.18	95.0	35.0	6
27247200	11.989	11.18	95.0	35.0	6
27247240	11.999	11.18	95.0	35.0	6
27247300	12.014	11.18	95.0	35.0	6
27247400	12.040	11.18	95.0	35.0	6
27247500	12.065	11.18	95.0	35.0	6
27247600	12.090	11.94	102.0	38.0	6
27247700	12.116	11.94	102.0	38.0	6
27247800	12.141	11.94	102.0	38.0	6
27247900	12.167	11.94	102.0	38.0	6
27248000	12.192	11.94	102.0	38.0	6
27248100	12.217	11.94	102.0	38.0	6
27248200	12.243	11.94	102.0	38.0	6
27248300	12.268	11.94	102.0	38.0	6
27248400	12.294	11.94	102.0	38.0	6
27248440	12.304	11.94	102.0	38.0	6
27248500	12.319	11.94	102.0	38.0	6
27248600	12.344	11.94	102.0	38.0	6
27248700	12.370	11.94	102.0	38.0	6
27248800	12.395	11.94	102.0	38.0	6
27248900	12.421	11.94	102.0	38.0	6
27249000	12.446	11.94	102.0	38.0	6
27249100	12.471	11.94	102.0	38.0	6
27249200	12.497	11.94	102.0	38.0	6
27249300	12.522	11.94	102.0	38.0	6
27249400	12.548	11.94	102.0	38.0	6
27249500	12.573	11.94	102.0	38.0	6
27249600	12.598	11.94	102.0	38.0	6
27249700	12.624	11.94	102.0	38.0	6
27249800	12.649	11.94	102.0	38.0	6
27249900	12.675	11.94	102.0	38.0	6
27249950	12.687	11.94	102.0	38.0	6
27249990	12.697	11.94	102.0	38.0	6
27250000	12.700	11.94	102.0	38.0	6
27250100	12.725	11.94	102.0	38.0	6
27251180	13.000	12.83	102.0	38.0	6
27251560	13.096	12.83	102.0	38.0	6
27253120	13.492	12.83	102.0	38.0	6
27254690	13.891	13.59	102.0	38.0	6
27255120	14.000	13.59	102.0	38.0	6
27256250	14.288	13.59	102.0	38.0	6
27257810	14.684	14.35	102.0	44.0	6
27259050	14.999	14.35	102.0	44.0	6
27259380	15.083	14.35	102.0	44.0	6
27260940	15.479	15.11	102.0	44.0	6
27262500	15.875	15.11	102.0	44.0	6
27262990	15.999	15.11	102.0	44.0	6



TrueSize® Solid Carbide Reamers Recommended cutting data

Conditions de coupe recommandées | Empfohlene Schnittdaten | Dati di taglio Raccomandati | Zalecane dane o Cięciu (Zalecane parametry skrawania)

Workpiece Material Group		Material Type	Vc (m/min)	Feed Type (Refer To Chart)
Steels	P	Low Carbon	60 - 90	M - H
		Medium Carbon	40 - 60	M
		Alloy Steels	20 - 40	L
		Mould/Tool Steel	20 - 40	L
Stainless Steels	M	Free Machining	45 - 75	M
		Austenitic	45 - 75	M
		Ferritic	25 - 40	M
		Martensitic	25 - 40	M
		PH Stainless	20 - 30	L - M
Special Alloys	S	High Temp Alloys (Ni)	15 - 20	L
		High Temp Alloys (Co)	10 - 15	L
		Titanium Alloys	10 - 15	L - M
Cast Irons	K	Grey Cast Iron	25 - 45	L - M
		Ductile Cast Iron	40 - 60	M
		Malleable Iron	40 - 60	M
Hardened Steels	H	< 25 HRc	60 - 90	M - H
		25 - 32 HRc	40 - 60	M
		32 - 43 HRc	15 - 40	L
		43 - 52 HRc	10 - 15	L
		> 52 HRc	5 - 10	L
Non Ferrous	N	Aluminium Alloys	150 - 300	M - H
		Copper & Hard Bronze	30 - 45	L
		Brass & Soft Bronze	50 - 80	M

$$\text{RPM} = \text{Vc (m/min)} \times 318.0 \div \text{Reamer } \varnothing$$

Series 272 - Recommended cutting data

Conditions de coupe recommandées | Empfohlene Schnittdaten | Dati di taglio Raccomandati | Zalecane dane o Cięciu (Zalecane parametry skrawania)

Nominal Reamer Diameter $\varnothing D^1$	Feed (mm/rev)		
	L	M	H
0.3mm - 1.6mm	0.01 - 0.03	0.02 - 0.05	0.03 - 0.08
1.6mm - 3.0mm	0.03 - 0.05	0.05 - 0.10	0.08 - 0.15
3.0mm - 6.0mm	0.05 - 0.10	0.10 - 0.15	0.15 - 0.25
6.0mm - 12.0mm	0.10 - 0.15	0.15 - 0.25	0.25 - 0.35
12.0mm - 16.0mm	0.15 - 0.25	0.25 - 0.50	0.35 - 0.75

Feedrate Formula For Metric Reamers - Feed = RPM x mm/rev

TrueSize® Reamer Tolerances

Résistances des alésoirs | Reibahlen – Toleranzen | Tolleranze degli alesatori | Tolerancja rozwiertaków

Tool Dimensions	Diameter (mm)	Tolerance (mm)
D ¹	0.330 - 16.000	DIN 1420 H7 (See Below)
D ²	0.330 - 16.000	+ 0.00 / - 0.03
L ¹	0.330 - 16.000	+ /- 1.5
L ²	0.330 - 16.000	+ /- 1.5

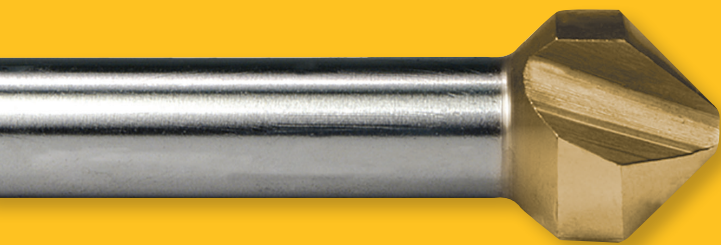

Countersinks

Fraises | Senker | Svasatori | Pogłębiacze

From the original M.A.Ford® single flute Uniflute® countersink for unrivalled economical, chatter free machining in both carbide and HSS options to multiple flute tools for increased feed rates for reduced chip loads, our wide choice and high quality countersinks provide the perfect solution.

(FR)

“Depuis la fraise originale M.A.Ford® une dent Uniflute® économiquement inégalable, ne générant pas de broutage, disponibles en carbure et HSS, en passant par les outils à goujures multiples pour des vitesses d’avance plus élevées et des copeaux réduits, notre large choix de fraises de grande qualité vous donnent accès aux meilleures solutions.”

(DE)

Unsere große Auswahl an Senkern und deren hochwertige Qualität stellen die perfekte Lösung zur Verfügung: vom originalen M.A.Ford® Uniflute®-Senker mit einer Schneide zur einzigartigen, wirtschaftlichen und ratterfreien Bearbeitung in sowohl Hartmetall- als auch HSS-Ausführungen bis zu Werkzeugen mit mehreren Schneiden für erhöhte Vorschubgeschwindigkeiten und vermindertes Zerspanungsvolumen.

(IT)

La soluzione perfetta per la svasatura: ampia scelta e alta qualità. Svasatori originali M.A.Ford® Uniflute® monotagliente, disponibili sia in HSS che in metallo duro, per la svasatura efficiente e senza vibrazioni. Svasatori multitagliente per alto avanzamento con riduzione del carico per tagliente.

(PL)

W naszej ofercie znajdują się jednostrzowe pogłębiacze Uniflute®, które oferują nieporównywalne wartości ekonomiczne i techniczne. Polecamy również opcje z wieloma rowkami wiórowymi które oferują wysokie wartości posuwu. Obydwie grupy produktów dostępne są w wersji HSS i z węgla.

	Page
Uniflute® Carbide Countersink Single Flute Series 60 Uncoated	198
Uniflute® HSS Countersink Single Flute Series 61 Steam Treated	198
Uniflute® HSS Countersink Single Flute Series 61B ALtima® Blaze Coated	199
Uniflute® HSS Countersink Single Flute Series 61T TiN Coated	199
Uniflute® HSS Countersink Sets Single Flute Series 61 Steam Treated & Series 61T TiN Coated	200
Vibration Free HSS Countersink 6 Flute Series 78 Uncoated	201
Vibration Free HSS Countersink 6 Flute Series 79 Steam Treated	201
Vibration Free HSS Countersink 6 Flute Series 79B ALtima® Blaze Coated & 79T TiN Coated	202
Vibration Free HSS Countersink Set 6 Flute Series 79 Steam Treated & 79T TiN Coated	203
HSS Aircraft Countersink 3 Flute Series 92 Bright Finish	204
HSS Aircraft Countersink Set 3 Flute Series 92 Bright Finish Set	204
HSS Countersink 3 Flute Series 893T TiN Coated	205
HSS Countersink Set 3 Flute Series 893T TiN Coated Set	205
Technical Information	206 - 208



FORDMAX

Countersinks
Fraises
Senker
Svasatori
Pogłębiacze

Uniflute® Carbide Countersink - Single Flute Series 60 Uncoated

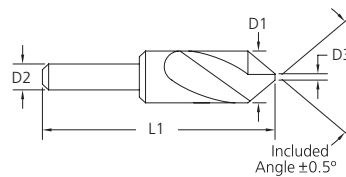
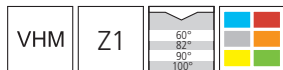

60°	82°	90°	100°	Tool Dimensions			
Tool No.	Tool No.	Tool No.	Tool No.	D1	D2	D3 (Max)	L1
60012501	60012502	60012503	60012504	1/8" 3.2mm	1/8" 3.2mm	0.030" 0.8mm	1-1/2" 38.1mm
60018701	60018702	60018703	60018704	3/16" 4.8mm	3/16" 4.8mm	0.045" 1.1mm	1-1/2" 38.1mm
60025001	60025002	60025003	60025004	1/4" 6.4mm	1/4" 6.4mm	0.045" 1.1mm	2" 50.8mm
60037501	60037502	60037503	60037504	3/8" 9.5mm	1/4" 6.4mm	0.06" 1.5mm	2" 50.8mm
60050001	60050002	60050003	60050004	1/2" 12.7mm	1/4" 6.4mm	0.06" 1.5mm	2-3/8" 60.3mm
60075001	60075002	60075003	60075004	3/4" 19.0mm	1/2" 12.7mm	0.120" 3.1mm	3" 76.2mm
60100001	60100002	60100003	60100004	1" 25.4mm	1/2" 12.7mm	0.120" 3.1mm	3" 76.2mm



Uniflute® HSS Countersink - Single Flute Series 61 Steam Treated

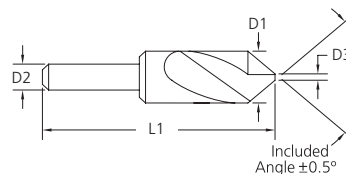
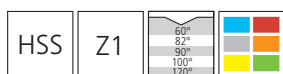

60°	82°	90°	100°	120°	Tool Dimensions			
Tool No.	Tool No.	Tool No.	Tool No.	Tool No.	D1	D2	D3 (Max)	L1
61012501	61012502	61012503	61012504	61012506	1/8" 3.2mm	1/8" 3.2mm	0.030" 0.8mm	1-1/2" 38.1mm
61018701	61018702	61018703	61018704	61018706	3/16" 4.8mm	3/16" 4.8mm	0.045" 1.1mm	1-1/2" 38.1mm
61025001	61025002	61025003	61025004	61025006	1/4" 6.4mm	1/4" 6.4mm	0.045" 1.1mm	2" 50.8mm
61037501	61037502	61037503	61037504	61037506	3/8" 9.5mm	1/4" 6.4mm	0.060" 1.5mm	2" 50.8mm
61050001	61050002	61050003	61050004	61050006	1/2" 12.7mm	1/4" 6.4mm	0.060" 1.5mm	2" 50.8mm
61062501	61062502	61062503	61062504	61062506	5/8" 15.9mm	1/4" 6.4mm	0.060" 1.5mm	2" 50.8mm
61075001	61075002	61075003	61075004	61075006	3/4" 19.0mm	1/2" 12.7mm	0.120" 3.1mm	2-3/4" 69.9mm
61100001	61100002	61100003	61100004	61100006	1" 25.4mm	1/2" 12.7mm	0.120" 3.1mm	2-3/4" 69.9mm
61125001	61125002	61125003	-	-	1-1/4" 31.8mm	1/2" 12.7mm	0.120" 3.1mm	3" 76.2mm
61150001	61150002	61150003	-	-	1-1/2" 38.1mm	3/4" 19.0mm	1/4" 6.4mm	3-1/2" 88.9mm
61200001	61200002	61200003	-	-	2" 50.8mm	3/4" 19.0mm	1/2" 12.7mm	3-3/4" 95.3mm
61250001	61250002	61250003	-	-	2-1/2" 63.5mm	3/4" 19.0mm	3/4" 19.0mm	5" 127.0mm
61300001	61300002	61300003	-	-	3" 76.2mm	3/4" 19.0mm	1" 25.4mm	5-1/4" 133.4mm



Uniflute® HSS Countersink - Single Flute Series 61B Coated

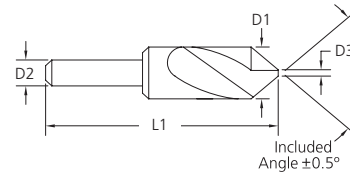
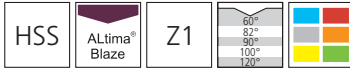

60°	82°	90°	100°	120°	Tool Dimensions			
Tool No.	Tool No.	Tool No.	Tool No.	Tool No.	D1	D2	D3 (Max)	L1
61B012501	61B012502	61B012503	61B012504	61B012506	1/8" 3.2mm	1/8" 3.2mm	0.030" 0.8mm	1-1/2" 38.1mm
61B018701	61B018702	61B018703	61B018704	61B018706	3/16" 4.8mm	3/16" 4.8mm	0.045" 1.1mm	1-1/2" 38.1mm
61B025001	61B025002	61B025003	61B025004	61B025006	1/4" 6.4mm	1/4" 6.4mm	0.045" 1.1mm	2" 50.8mm
61B037501	61B037502	61B037503	61B037504	61B037506	3/8" 9.5mm	1/4" 6.4mm	0.060" 1.5mm	2" 50.8mm
61B050001	61B050002	61B050003	61B050004	61B050006	1/2" 12.7mm	1/4" 6.4mm	0.060" 1.5mm	2" 50.8mm
61B062501	61B062502	61B062503	61B062504	61B062506	5/8" 15.9mm	1/4" 6.4mm	0.060" 1.5mm	2" 50.8mm
61B075001	61B075002	61B075003	61B075004	61B075006	3/4" 19.0mm	1/2" 12.7mm	0.120" 3.1mm	2-3/4" 69.9mm
61B100001	61B100002	61B100003	61B100004	61B100006	1" 25.4mm	1/2" 12.7mm	0.120" 3.1mm	2-3/4" 69.9mm



Uniflute® HSS Countersink - Single Flute Series 61T Coated

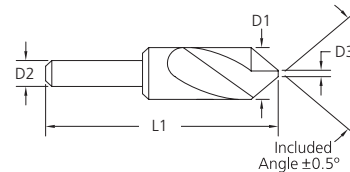
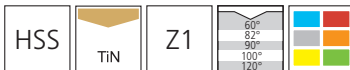

60°	82°	90°	100°	120°	Tool Dimensions			
Tool No.	Tool No.	Tool No.	Tool No.	Tool No.	D1	D2	D3 (Max)	L1
61T012501	61T012502	61T012503	61T012504	61T012506	1/8" 3.2mm	1/8" 3.2mm	0.030" 0.8mm	1-1/2" 38.1mm
61T018701	61T018702	61T018703	61T018704	61T018706	3/16" 4.8mm	3/16" 4.8mm	0.045" 1.1mm	1-1/2" 38.1mm
61T025001	61T025002	61T025003	61T025004	61T025006	1/4" 6.4mm	1/4" 6.4mm	0.045" 1.1mm	2" 50.8mm
61T037501	61T037502	61T037503	61T037504	61T037506	3/8" 9.5mm	1/4" 6.4mm	0.060" 1.5mm	2" 50.8mm
61T050001	61T050002	61T050003	61T050004	61T050006	1/2" 12.7mm	1/4" 6.4mm	0.060" 1.5mm	2" 50.8mm
61T062501	61T062502	61T062503	61T062504	61T062506	5/8" 15.9mm	1/4" 6.4mm	0.060" 1.5mm	2" 50.8mm
61T075001	61T075002	61T075003	61T075004	61T075006	3/4" 19.0mm	1/2" 12.7mm	0.120" 3.1mm	2-3/4" 69.9mm
61T100001	61T100002	61T100003	61T100004	61T100006	1" 25.4mm	1/2" 12.7mm	0.120" 3.1mm	2-3/4" 69.9mm



Uniflute® HSS Countersink Sets - Single Flute Series 61 Steam Treated

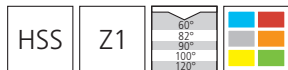

4pc Set - Series 61	
Set Includes - 1/4" (6.4mm), 1/2" (12.7mm), 3/4" (19.0mm) & 1" (25.4mm)	
Set No.	Angle
64100001	60°
64100002	82°
64100003	90°
64100004	100°
64100006	120°

7pc Set - Series 61	
Set Includes - 3/16" (4.8mm), 1/4" (6.4mm), 3/8" (9.5mm), 1/2" (12.7mm), 5/8" (15.9mm), 3/4" (19.0mm) & 1" (25.4mm)	
Set No.	Angle
64100071	60°
64100072	82°
64100073	90°
64100074	100°
64100076	120°



Series 61T TiN Coated

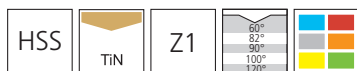

4pc Set - Series 61T	
Set Includes - 1/4" (6.4mm), 1/2" (12.7mm), 3/4" (19.0mm), 1" (25.4mm)	
Set No.	Angle
64T100001	60°
64T100002	82°
64T100003	90°



Vibration Free HSS Countersink - 6 Flute Series 78 Uncoated

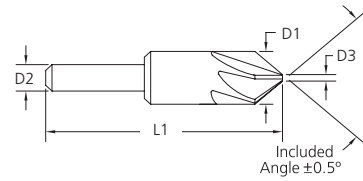
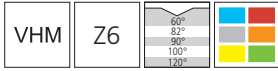

60°	82°	90°	100°	120°	Tool Dimensions			
Tool No.	Tool No.	Tool No.	Tool No.	Tool No.	D1	D2	D3 (Max)	L1
78012501	78012502	78012503	78012504	78012506	1/8" 3.2mm	1/8" 3.2mm	0.030" 0.8mm	1-1/2" 38.1mm
78018701	78018702	78018703	78018704	78018706	3/16" 4.8mm	3/16" 4.8mm	0.045" 1.1mm	1-1/2" 38.1mm
78025001	78025002	78025003	78025004	78025006	1/4" 6.4mm	1/4" 6.4mm	0.060" 1.5mm	2" 50.8mm
78037501	78037502	78037503	78037504	78037506	3/8" 9.5mm	1/4" 6.4mm	0.090" 2.3mm	2" 50.8mm
78050001	78050002	78050003	78050004	78050006	1/2" 12.7mm	3/8" 9.5mm	0.150" 3.8mm	2-1/8" 54.0mm
78062501	78062502	78062503	78062504	78062506	5/8" 15.9mm	3/8" 9.5mm	0.180" 4.6mm	2-3/8" 60.3mm
78075001	78075002	78075003	78075004	78075006	3/4" 19.0mm	1/2" 12.7mm	0.210" 5.3mm	2-3/4" 69.9mm
78100001	78100002	78100003	78100004	78100006	1" 25.4mm	1/2" 12.7mm	1/4" 6.4mm	2-3/4" 69.9mm
78125001	78125002	78125003	-	-	1-1/4" 31.8mm	1/2" 12.7mm	0.370" 9.4mm	3" 76.2mm
78150001	78150002	78150003	-	-	1-1/2" 38.1mm	3/4" 19.0mm	0.430" 10.9mm	3-1/2" 88.9mm



Vibration Free HSS Countersink - 6 Flute Series 79 Steam Treated

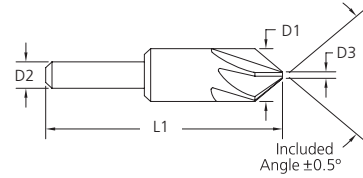
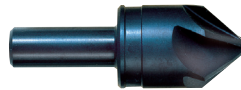

60°	82°	90°	100°	120°	Tool Dimensions			
Tool No.	Tool No.	Tool No.	Tool No.	Tool No.	D1	D2	D3 (Max)	L1
79012501	79012502	79012503	79012504	79012506	1/8" 3.2mm	1/8" 3.2mm	0.030" 0.8mm	1-1/2" 38.1mm
79018701	79018702	79018703	79018704	79018706	3/16" 4.8mm	3/16" 4.8mm	0.045" 1.1mm	1-1/2" 38.1mm
79025001	79025002	79025003	79025004	79025006	1/4" 6.4mm	1/4" 6.4mm	0.060" 1.5mm	2" 50.8mm
79031201	79031202	79031203	79031204	79031206	5/16" 7.9mm	1/4" 6.4mm	0.080" 2.0mm	2" 50.8mm
79037501	79037502	79037503	79037504	79037506	3/8" 9.5mm	1/4" 6.4mm	0.090" 2.3mm	2" 50.8mm
79050001	79050002	79050003	79050004	79050006	1/2" 12.7mm	3/8" 9.5mm	0.150" 3.8mm	2" 50.8mm
79062501	79062502	79062503	79062504	79062506	5/8" 15.9mm	3/8" 9.5mm	0.180" 4.6mm	2-1/4" 57.1mm
79075001	79075002	79075003	79075004	79075006	3/4" 19.0mm	1/2" 12.7mm	0.210" 5.3mm	2-3/4" 69.9mm
79087501	79087502	79087503	79087504	79087506	7/8" 22.2mm	1/2" 12.7mm	0.230" 5.8mm	2-3/4" 69.9mm
79100001	79100002	79100003	79100004	79100006	1" 25.4mm	1/2" 12.7mm	1/4" 6.4mm	2-3/4" 69.9mm
79125001	79125002	79125003	79125004	79125006	1-1/4" 31.8mm	1/2" 12.7mm	0.370" 9.4mm	3" 76.2mm
79150001	79150002	79150003	79150004	79150006	1-1/2" 38.1mm	3/4" 19.0mm	0.430" 10.9mm	3-1/2" 88.9mm
79200001	79200002	79200003	79200004	79200006	2" 50.8mm	3/4" 19.0mm	0.620" 15.7mm	3-3/4" 95.2mm
79250001	79250002	79250003	-	-	2-1/2" 63.5mm	3/4" 19.0mm	3/4" 19.0mm	5" 127.0mm
79300001	79300002	79300003	-	-	3" 76.2mm	3/4" 19.0mm	1" 25.4mm	5-1/4" 133.4mm



Vibration Free HSS Countersink - 6 Flute Series 79B Coated

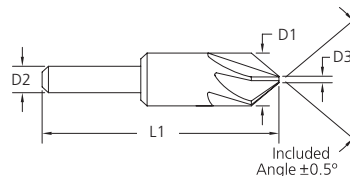

60°	82°	90°	100°	120°	Tool Dimensions			
Tool No.	Tool No.	Tool No.	Tool No.	Tool No.	D1	D2	D3 (Max)	L1
79B012501	79B012502	79B012503	79B012504	79B012506	1/8" 3.2mm	1/8" 3.2mm	0.030" 0.8mm	1-1/2" 38.1mm
79B018701	79B018702	79B018703	79B018704	79B018706	3/16" 4.8mm	3/16" 4.8mm	0.045" 1.1mm	1-1/2" 38.1mm
79B025001	79B025002	79B025003	79B025004	79B025006	1/4" 6.4mm	1/4" 6.4mm	0.060" 1.5mm	2" 50.8mm
79B037501	79B037502	79B037503	79B037504	79B037506	3/8" 9.5mm	1/4" 6.4mm	0.090" 2.3mm	2" 50.8mm
79B050001	79B050002	79B050003	79B050004	79B050006	1/2" 12.7mm	3/8" 9.5mm	0.150" 3.8mm	2" 50.8mm
79B062501	79B062502	79B062503	79B062504	79B062506	5/8" 15.9mm	3/8" 9.5mm	0.180" 4.6mm	2-1/4" 57.1mm
79B075001	79B075002	79B075003	79B075004	79B075006	3/4" 19.0mm	1/2" 12.7mm	0.210" 5.3mm	2-3/4" 69.9mm
79B100001	79B100002	79B100003	79B100004	79B100006	1" 25.4mm	1/2" 12.7mm	1/4" 6.4mm	2-3/4" 69.9mm



Vibration Free HSS Countersink - 6 Flute Series 79T Coated

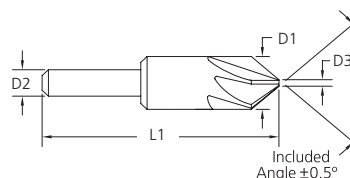
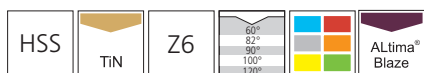

60°	82°	90°	100°	120°	Tool Dimensions			
Tool No.	Tool No.	Tool No.	Tool No.	Tool No.	D1	D2	D3 (Max)	L1
79T012501	79T012502	79T012503	79T012504	79T012506	1/8" 3.2mm	1/8" 3.2mm	0.030" 0.8mm	1-1/2" 38.1mm
79T018701	79T018702	79T018703	79T018704	79T018706	3/16" 4.8mm	3/16" 4.8mm	0.045" 1.1mm	1-1/2" 38.1mm
79T025001	79T025002	79T025003	79T025004	79T025006	1/4" 6.4mm	1/4" 6.4mm	0.060" 1.5mm	2" 50.8mm
79T037501	79T037502	79T037503	79T037504	79T037506	3/8" 9.5mm	1/4" 6.4mm	0.090" 2.3mm	2" 50.8mm
79T050001	79T050002	79T050003	79T050004	79T050006	1/2" 12.7mm	3/8" 9.5mm	0.150" 3.8mm	2" 50.8mm
79T062501	79T062502	79T062503	79T062504	79T062506	5/8" 15.9mm	3/8" 9.5mm	0.180" 4.6mm	2-1/4" 57.1mm
79T075001	79T075002	79T075003	79T075004	79T075006	3/4" 19.0mm	1/2" 12.7mm	0.210" 5.3mm	2-3/4" 69.9mm
79T100001	79T100002	79T100003	79T100004	79T100006	1" 25.4mm	1/2" 12.7mm	1/4" 6.4mm	2-3/4" 69.9mm



Vibration Free HSS Countersink - 6 Flute Sets Series 79 Steam Treated



4pc Set - Series 79

Set Includes - 1/4" (6.4mm), 1/2" (12.7mm)
3/4" (19.0mm), 1" (25.4mm)

Set No.	Angle
79000011	60°
79000012	82°
79000013	90°
79000014	100°

7pc Set - Series 79

Set Includes - 1/4" (6.4mm), 5/16" (7.9mm), 3/8" (9.5mm)
1/2" (12.7mm), 5/8" (15.9mm), 3/4" (19.0mm), 1" (25.4mm)

Set No.	Angle
79000001	60°
79000002	82°
79000003	90°
79000004	100°



Vibration Free HSS Countersink - 6 Flute Set Series 79T Coated

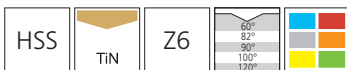

4pc Set - Series 79T

Set Includes - 1/4" (6.4mm), 1/2" (12.7mm)
3/4" (19.0mm), 1" (25.4mm)

Set No.	Angle
79T000011	60°
79T000012	82°
79T000013	90°



HSS Aircraft Countersink - 3 Flute Series 92 Bright Finish

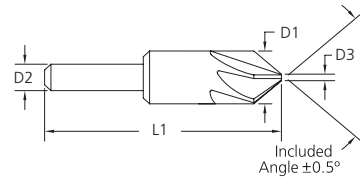

60°	82°	90°	100°	120°	Tool Dimensions			
Tool No.	Tool No.	Tool No.	Tool No.	Tool No.	D1	D2	D3 (Max)	L1
92025001	92025002	92025003	92025004	92025006	1/4" 6.4mm	1/4" 6.4mm	0.070" 1.8mm	1-1/4" 31.8mm
92037501	92037502	92037503	92037504	92037506	3/8" 9.5mm	1/4" 6.4mm	0.110" 2.8mm	1-5/8" 41.3mm
92050001	92050002	92050003	92050004	92050006	1/2" 12.7mm	1/4" 6.4mm	0.150" 3.8mm	2" 50.8mm
92062501	92062502	92062503	92062504	92062506	5/8" 15.9mm	1/4" 6.4mm	0.190" 4.8mm	2-1/4" 57.1mm
92075001	92075002	92075003	92075004	92075006	3/4" 19.0mm	1/2" 12.7mm	0.230" 5.8mm	3" 76.2mm
92087501	92087502	92087503	92087504	92087506	7/8" 22.2mm	1/2" 12.7mm	0.260" 6.6mm	3" 76.2mm
92100001	92100002	92100003	92100004	92100006	1" 25.4mm	1/2" 12.7mm	0.300" 7.6mm	3-1/4" 82.5mm
92112501	92112502	92112503	92112504	92112506	1-1/8" 28.6mm	1/2" 12.7mm	0.340" 8.6mm	3-1/4" 82.5mm
92125001	92125002	92125003	92125004	92125006	1-1/4" 31.8mm	5/8" 15.9mm	0.380" 9.6mm	3-1/2" 88.9mm
92150001	92150002	92150003	92150004	92150006	1-1/2" 38.1mm	3/4" 19.0mm	0.450" 11.4mm	3-7/8" 98.4mm
92200001	92200002	92200003	92200004	92200006	2" 50.8mm	3/4" 19.0mm	0.600" 15.2mm	4-1/4" 107.9mm



HSS Aircraft Countersink Set - 3 Flute Series 92 Bright Finish

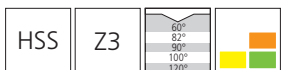

FORDMAX
 Countersinks
 Fraises
 Senker
 Svasatori
 Pogłębiacze

5pc Set - Series 92	
Set Includes - 1/4" (6.4mm), 3/8" (9.5mm), 1/2" (12.7mm) 5/8" (15.9mm) & 3/4" (19.0mm)	
Set No.	Angle
92000011	60°
92000012	82°
92000013	90°
92000014	100°
92000016	120°



HSS Countersink - 3 Flute Series 893T Coated

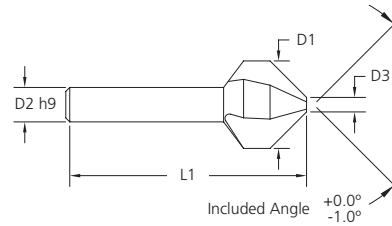

90°	Tool Dimensions				
Tool No.	Fastner Size	D1	D2	D3 (Max)	L1
893 0430T	M2	4.3	4.0	1.3	40.0
893 0500T	M2.5	5.0	4.0	1.5	40.0
893 0600T	M3	6.0	5.0	1.5	45.0
893 0630T	M3	6.3	5.0	1.5	45.0
893 0700T	M3.5	7.0	6.0	1.8	50.0
893 0800T	M4	8.0	6.0	2.0	50.0
893 0830T	M4	8.3	6.0	2.0	50.0
893 1000T	M5	10.0	6.0	2.5	50.0
893 1040T	M5	10.4	6.0	2.5	50.0
893 1150T	M6	11.5	8.0	2.8	56.0
893 1240T	M6	12.4	8.0	2.8	56.0
893 1500T	M8	15.0	10.0	3.2	60.0
893 1650T	M8	16.5	10.0	3.2	60.0
883 1900T	M10	19.0	10.0	3.5	63.0
893 2050T	M10	20.5	10.0	3.5	63.0
893 2300T	M12	23.0	10.0	3.8	67.0
893 2500T	M12	25.0	10.0	3.8	67.0
893 3100T	M16	31.0	12.0	4.2	71.0



HSS Countersink Set - 3 Flute Series 893T



6pc Set - Series 893T	
Set Includes - 6.3mm, 8.3mm, 10.4mm 12.4mm, 16.5mm & 20.5mm	
Set No.	Angle
893T 6PC 90 DEG	90°



Countersinks
Fraises
Senker
Svasatori
Pogłębiacze

HSS & Carbide Countersinks

Uniflute® Countersink Feed Rates

Uniflute® countersinks are designed with cam relief, therefore feed rates should not exceed 0.125mm per revolution on larger diameter holes. Reduced feeds are recommended for smaller diameter holes. A controlled feed results in vibration-free finishes associated with Uniflute® countersinks.

Multiple Flute Countersink Feed Rates

Multiple flute countersinks are designed for increased feed rates. Because there is more than one cutting edge, tooth loads are not excessive so vibration can be controlled, allowing higher feedrates.

Speeds

To determine optimum speed, start at the lower end of the cutting speed range shown in the chart below, increasing the speed until performance is maximized. When a countersink is operated at excessive RPM, vibration may result and the cutting edges can overheat and become prematurely worn.

Workpiece Material Group		Material Type	Vc (m/min)			
			HSS	HSS TiN Coated	HSS ALtima® Blaze Coated	Carbide
Steels	P	Low Carbon	25 - 30	30 - 40	40 - 50	40 - 50
		Medium Carbon	20 - 25	25 - 30	35 - 40	35 - 45
		Alloy Steels	15 - 20	20 - 25	25 - 30	20 - 30
Stainless Steels	M	Free Machining	10 - 25	10 - 30	15 - 40	25 - 40
		Difficult Stainless	5 - 10	5 - 20	10 - 25	15 - 25
Special Alloys	S	High Temperature Alloys	5 - 8	5 - 10	5 - 10	8 - 15
		Titanium Alloys	15 - 20	20 - 25	25 - 30	20 - 30
Cast Irons	K	Cast Iron	15 - 30	20 - 40	25 - 50	30 - 55
		Malleable Iron	25 - 30	30 - 35	40 - 45	30 - 45
Hardened Steels	H	45 - 50 HRC	5 - 10	5 - 10	8 - 10	8 - 15
		50 - 55 HRC	2 - 5	3 - 5	5 - 10	5 - 10
Non Ferrous	N	Aluminium Alloys	45 - 75	60 - 100	75 - 120	90 - 150
		Brass / Bronze	25 - 40	30 - 50	35 - 60	45 - 80

Conversion Formula

$$\text{RPM} = \text{Vc (m/min)} \times 318.0 \div \text{Countersink } \varnothing *$$

* Countersink \varnothing Must Be Calculated in mm
 (When making the calculation, use the diameter on the countersink where the cutting is actually taking place)

HSS & Carbide Countersinks

Minimum Body Diameter for 90° Flat Head Cap Screws (mm)

Cap Screw Size (mm)	Countersink Diameter (mm)
M3	7.0
M4	10.0
M5	12.0
M6	14.0
M8	19.0
M10	23.0
M12	25.0
M16	31.0

Size Diameter Gain for every 0.025mm of Axial Depth in to a Pre-Drilled Hole

Included Angle	Axial Depth (mm)	Diameter Gain (mm)
30°	0.025	0.0127
45°	0.025	0.0203
60°	0.025	0.0254
82°	0.025	0.0432
90°	0.025	0.0508
100°	0.025	0.0711
120°	0.025	0.0864

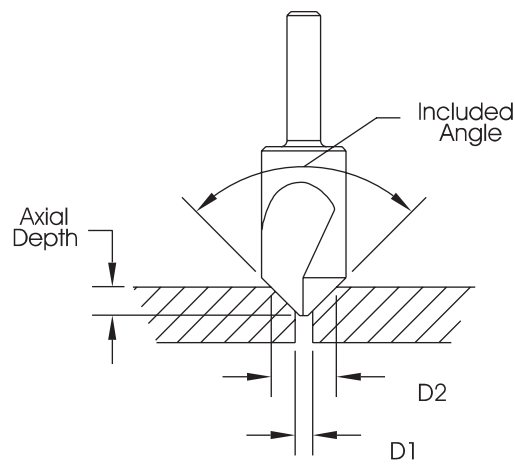

$\text{DIAMETER GAIN} = D2 - D1$



HSS & Carbide Countersinks

All M.A.Ford® HSS countersinks are heat treated in an electronically controlled vacuum furnace. This assures precise hardening and eliminates the possibility of decarburization. All heat treating is done in our own facilities for maximum control and assurance of desired hardness and toughness.

Most M.A.Ford® HSS countersinks receive an additional heat treat process known as the Steam Homogeneous Process. This process is like a final tempering, relieving internal grinding stresses. The result is a much tougher cutting edge that stays sharper, longer. Additionally, the Steam Homogeneous Process provides a tough, hard, porous oxide film on the tool that is sufficient enough to retain cutting oil, further reducing frictional heat and extending tool life.

Coated Countersinks



Coating Properties

	TiN	ALtima® Blaze
Micro Hardness (HV)	2300	3200
Max. Working Temperature	600° C 1112° F	1100° C 2012° F
Friction Coefficient	0.40	0.35

ALtima® Blaze

features high temperature hardness and oxidation resistance that provides extreme wear resistance under all machining conditions.

TiN

provides a higher surface hardness and increased lubricity over an uncoated tool.

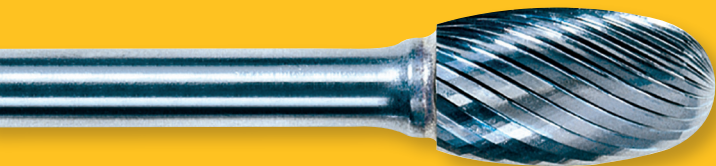

For aggressive cutting action, smooth operation and long tool life, M.A.Ford® Edgehog® carbide burrs are by far the most effective solution for even the most demanding de-burring and pre-finishing applications. With more than 160 different tool shapes and sizes available in our Edgehog range, including cylindrical, conical, ball and countersink styles, there's a burr to meet virtually every application.

FR

“Pour les actions de coupe agressives, un bon fonctionnement et une longue durée de vie de l'outil, les fraises en carbure M.A.Ford® Edgehog® sont de loin la solution la plus efficace pour les applications d'ébavurage et de pré-finition même les plus exigeantes. Avec plus de 160 différentes formes et tailles d'outils disponibles dans notre gamme Edgehog, incluant les formes de fraises cylindriques, coniques, ronds: il existe un outil d'ébavurage pour pratiquement n'importe quel type d'application.”

DE

Bei sehr intensiven Schnitvorgängen und für eine reibungslose Funktion sowie lange Werkzeugstandzeiten stellen die Edgehog®-Hartmetallentgrater von M.A.Ford® bei Weitem die effektivste Lösung sogar bei den anspruchsvollsten Entgratungs- und Nachbearbeitungsanwendungen dar. Unser Edgehog-Sortiment umfasst mehr als 160 verschiedene Werkzeugformen und -größen, einschließlich zylindrische, konische, kugelförmige sowie Senker-Formen, und daher steht für nahezu jede Anwendung ein Entgrater zur Verfügung.

IT

Per un taglio aggressivo ma scorrevole ed una lunga vita utensile, le lime rotative in metallo duro M.A.Ford® Edgehog® sono certamente la soluzione più efficace, anche per le operazioni di sbavatura e pre-finitura più impegnative. Con più di 160 utensili di diverse geometrie (tra cui cilindriche, coniche, sferiche e tipo svasatore) e misure disponibili, nella gamma Edgehog c'è la lima rotative idonea per qualsiasi applicazione.

PL

Pilniki obrotowe z węgla M.A.Ford® Edgehog® umożliwiają pracę w wymagających warunkach przy zachowaniu długiej żywotności narzędzia. Są zdecydowanie najbardziej efektywnym rozwiązaniem dla najbardziej wymagających operacji szlifowania. W naszej ofercie M.A.Ford® Edgehog® znajduje się ponad 160 narzędzi o różnych średnicach i kształtach (cylindryczne, kulowe, stożkowe).

Edgehog®

Carbide Burrs

Fraise Lime Rotative Carbure Hartmetall-Frässtifte
Lime rotative in MD Zadziory

	Page
Edgehog® Carbide Burrs Series SA	210
Edgehog® Carbide Burrs Series SB	211
Edgehog® Carbide Burrs Series SC	212
Edgehog® Carbide Burrs Series SD	213
Edgehog® Carbide Burrs Series SE	214
Edgehog® Carbide Burrs Series SF	215
Edgehog® Carbide Burrs Series SG	216
Edgehog® Carbide Burrs Series SH	217
Edgehog® Carbide Burrs Series SJ	218
Edgehog® Carbide Burrs Series SK	219
Edgehog® Carbide Burrs Series SL	220
Edgehog® Carbide Burrs Series SM	221
Edgehog® Carbide Burrs Series SN	222
Technical Information	223 - 224



Edgehog® Carbide Burrs Series SA

Type A

Cylinder

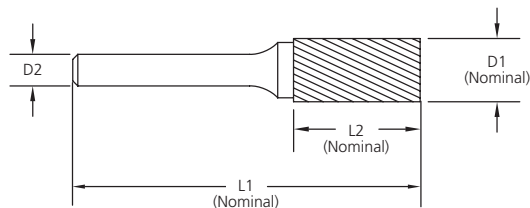

3mm Shank Burrs



Standard Cut Tool No.	Alt Diamond Tool No.	Fine Cut Tool No.	Shear Cut Tool No.	Tool Dimensions			
				D1	D2	L1	L2
SA-41M	SA-41M-D	SA-41M-F	-	1.6	3.0	38.0	6.0
SA-42M	SA-42M-D	SA-42M-F	-	2.4	3.0	38.0	11.1
SA-43M	SA-43M-D	SA-43M-F	-	3.0	3.0	38.0	14.3
SA-52M	SA-52M-D	SA-52M-F	-	4.0	3.0	38.0	12.7
SA-53M	SA-53M-D	SA-53M-F	-	4.8	3.0	38.0	12.7
SA-51M	SA-51M-D	SA-51M-F	-	6.4	3.0	51.0	12.7

6mm Shank Burrs



Standard Cut Tool No.	Alt Diamond Tool No.	Fine Cut Tool No.	Shear Cut Tool No.	Tool Dimensions			
				D1	D2	L1	L2
SA-11M	SA-11M-D	-	-	3.0	6.0	50.0	12.7
SA-13M	-	-	-	4.0	6.0	50.0	16.0
-	SA-14M-D	-	-	4.8	6.0	50.0	16.0
SA-1M	SA-1M-D	SA-1M-F	-	6.0	6.0	50.0	16.0
SA-2M	SA-2M-D	-	-	8.0	6.0	64.0	19.0
SA-3M	SA-3M-D	SA-3M-F	SA-3NFM	9.5	6.0	64.0	19.0
SA-3MZ	SA-3MZ-D	SA-3MZ-F	-	10.0	6.0	65.0	20.0
SA-4M	SA-4M-D	-	-	11.0	6.0	70.0	25.0
SA-5MZ	SA-5MZ-D	-	-	12.0	6.0	70.0	25.0
SA-5M	SA-5M-D	SA-5M-F	SA-5NFM	12.7	6.0	70.0	25.0
SA-6M	SA-6M-D	SA-6M-F	SA-6NFM	16.0	6.0	70.0	25.0
SA-15M	-	-	-	19.0	6.0	58.0	12.7
SA-7M	SA-7M-D	SA-7M-F	-	19.0	6.0	70.0	25.0
SA-9M	SA-9M-D	SA-9M-F	-	25.0	6.0	70.0	25.0



3mm Shank Burrs

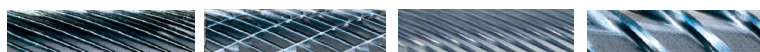

Standard Cut Tool No.	Alt Diamond Tool No.	Fine Cut Tool No.	Shear Cut Tool No.	Tool Dimensions			
				D1	D2	L1	L2
SA-43L76M	SA-43L76M-D	-	-	3.0	3.0	76.0	14.3

Note: Burrs 12.0mm and above are available with an 8.0mm shank on request as a non-stock standard.



Edgehog® Carbide Burrs Series SB



Type B

Cylinder - With End Cut

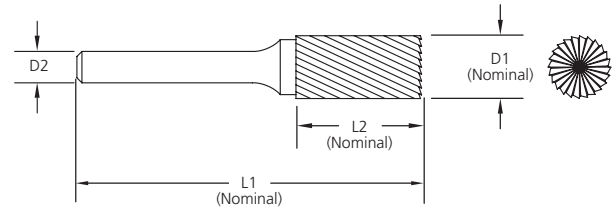
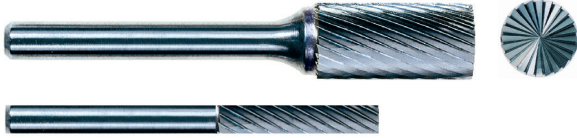

3mm Shank Burrs

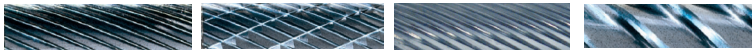

Standard Cut Tool No.	Alt Diamond Tool No.	Fine Cut Tool No.	Shear Cut Tool No.	Tool Dimensions			
				D1	D2	L1	L2
SB-51M	SB-51M-D	SB-51M-F	-	6.4	3.0	43.0	4.8

6mm Shank Burrs

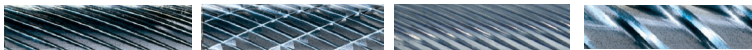

Standard Cut Tool No.	Alt Diamond Tool No.	Fine Cut Tool No.	Shear Cut Tool No.	Tool Dimensions			
				D1	D2	L1	L2
SB-11M	SB-11M-D	-	-	3.0	6.0	50.0	12.7
SB-13M	SB-13M-D	-	-	4.0	6.0	50.0	16.0
-	SB-14M-D	-	-	4.8	6.0	50.0	16.0
SB-1M	SB-1M-D	SB-1M-F	-	6.0	6.0	50.0	16.0
SB-2M	SB-2M-D	SB-2M-F	-	8.0	6.0	64.0	19.0
SB-3M	SB-3M-D	SB-3M-F	SB-3NFM	9.5	6.0	64.0	19.0
SB-3MZ	SB-3MZ-D	SB-3MZ-F	-	10.0	6.0	65.0	20.0
SB-4M	SB-4M-D	-	-	11.0	6.0	70.0	25.0
SB-5MZ	SB-5MZ-D	SB-5MZ-F	-	12.0	6.0	70.0	25.0
SB-5M	SB-5M-D	-	SB-5NFM	12.7	6.0	70.0	25.0
SB-6M	SB-6M-D	-	-	16.0	6.0	70.0	25.0
-	SB-16M-D	-	-	19.0	6.0	64.0	19.0
-	SB-7M-D	SB-7M-F	-	19.0	6.0	70.0	25.0
SB-9M	SB-9M-D	-	-	25.0	6.0	70.0	25.0

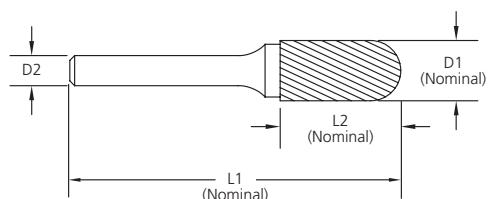
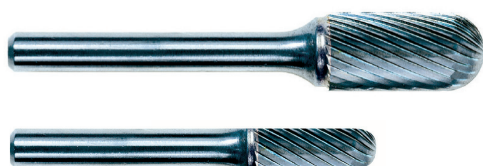

Edgehog® Carbide Burrs Series SC

Type C
Ball Nosed Cylinder

3mm Shank Burrs



Standard Cut Tool No.	Alt Diamond Tool No.	Fine Cut Tool No.	Shear Cut Tool No.
SC-41M	SC-41M-D	SC-41M-F	-
SC-42M	SC-42M-D	SC-42M-F	-
SC-52M	SC-52M-D	SC-52M-F	-
SC-53M	SC-53M-D	SC-53M-F	-
SC-51M	SC-51M-D	SC-51M-F	-

Tool Dimensions			
D1	D2	L1	L2
2.4	3.0	38.0	11.1
3.0	3.0	38.0	14.3
4.0	3.0	38.0	12.7
4.8	3.0	38.0	12.7
6.4	3.0	51.0	12.7

6mm Shank Burrs



Standard Cut Tool No.	Alt Diamond Tool No.	Fine Cut Tool No.	Shear Cut Tool No.
-	SC-11M-D	-	-
SC-13M	SC-13M-D	-	-
SC-14M	SC-14M-D	-	-
SC-1M	SC-1M-D	SC-1M-F	-
SC-2M	SC-2M-D	SC-2M-F	-
SC-3M	SC-3M-D	SC-3M-F	SC-3NFM
SC-3MZ	SC-3MZ-D	SC-3MZ-F	-
SC-4M	SC-4M-D	-	-
SC-5MZ	SC-5MZ-D	SC-5MZ-F	-
SC-5M	SC-5M-D	SC-5M-F	SC-5NFM
SC-6M	SC-6M-D	SC-6M-F	SC-6NFM
SC-7M	SC-7M-D	-	-
SC-9M	SC-9M-D	-	-

Tool Dimensions			
D1	D2	L1	L2
3.0	6.0	50.0	12.7
4.0	6.0	50.0	16.0
4.8	6.0	50.0	16.0
6.0	6.0	50.0	16.0
8.0	6.0	64.0	19.0
9.5	6.0	64.0	19.0
10.0	6.0	65.0	20.0
11.0	6.0	70.0	25.0
12.0	6.0	70.0	25.0
12.7	6.0	70.0	25.0
16.0	6.0	70.0	25.0
19.0	6.0	70.0	25.0
25.0	6.0	70.0	25.0



3mm Shank Burrs

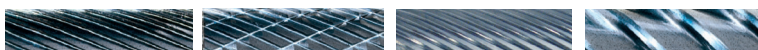

Standard Cut Tool No.	Alt Diamond Tool No.	Fine Cut Tool No.	Shear Cut Tool No.
SC-42L76M	SC-42L76M-D	-	-

Tool Dimensions			
D1	D2	L1	L2
3.0	3.0	76.0	14.3



6mm Shank Burrs



Standard Cut Tool No.	Alt Diamond Tool No.	Fine Cut Tool No.	Shear Cut Tool No.
SC-1L6M	-	-	-
SC-3L6M	-	-	-
SC-5L6M	SC-5L6M-D	SC-5L6M-F	-

Tool Dimensions			
D1	D2	L1	L2
6.0	6.0	166.0	16.0
9.5	6.0	169.0	19.0
12.7	6.0	175.0	25.0

Note: Burrs 12.0mm and above are available with an 8.0mm shank on request as a non-stock standard.



Edgehog® Carbide Burrs Series SD



Type D

Ball

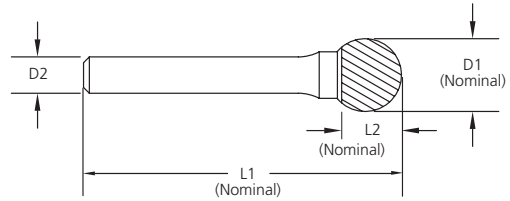

3mm Shank Burrs

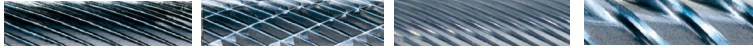

Standard Cut Tool No.	Alt Diamond Tool No.	Fine Cut Tool No.	Shear Cut Tool No.
SD-41M	SD-41M-D	SD-41M-F	-
SD-42M	SD-42M-D	SD-42M-F	-
SD-53M	SD-53M-D	SD-53M-F	-
SD-51M	SD-51M-D	SD-51M-F	-

Tool Dimensions			
D1	D2	L1	L2
2.4	3.0	38.0	2.0
3.0	3.0	38.0	2.8
4.8	3.0	38.0	4.0
6.4	3.0	44.0	5.6

6mm Shank Burrs

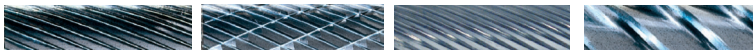

Standard Cut Tool No.	Alt Diamond Tool No.	Fine Cut Tool No.	Shear Cut Tool No.
SD-11M	SD-11M-D	-	-
SD-14M	SD-14M-D	SD-14M-F	-
SD-1M	SD-1M-D	SD-1M-F	-
SD-2M	SD-2M-D	-	-
SD-3M	SD-3M-D	SD-3M-F	SD-3NFM
SD-3MZ	SD-3MZ-D	SD-3MZ-F	-
SD-4M	SD-4M-D	SD-4M-F	-
SD-5MZ	-	-	-
SD-5M	SD-5M-D	SD-5M-F	SD-5NFM
SD-6M	SD-6M-D	SD-6M-F	SD-6NFM
SD-7M	SD-7M-D	-	-
SD-9M	SD-9M-D	-	-

Tool Dimensions			
D1	D2	L1	L2
3.0	6.0	50.0	2.8
4.8	6.0	50.0	4.0
6.0	6.0	50.0	5.0
8.0	6.0	51.0	6.0
9.5	6.0	53.0	7.0
10.0	6.0	54.0	7.0
11.0	6.0	54.0	8.0
12.0	6.0	56.0	9.5
12.7	6.0	56.0	10.0
16.0	6.0	59.0	13.0
19.0	6.0	62.0	16.0
25.0	6.0	68.0	21.0



3mm Shank Burrs



Standard Cut Tool No.	Alt Diamond Tool No.	Fine Cut Tool No.	Shear Cut Tool No.
SD-42L76M	SD-42L76M-D	-	-

Tool Dimensions			
D1	D2	L1	L2
3.0	3.0	76.0	2.8



6mm Shank Burrs

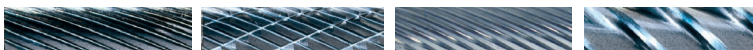

Standard Cut Tool No.	Alt Diamond Tool No.	Fine Cut Tool No.	Shear Cut Tool No.
-	SD-1L6M-D	-	-
-	SD-2L6M-D	-	-
SD-3L6M	SD-3L6M-D	SD-3L6M-F	-
SD-5L6M	SD-5L6M-D	SD-5L6M-F	-

Tool Dimensions			
D1	D2	L1	L2
6.0	6.0	155.0	5.0
8.0	6.0	159.0	6.0
9.5	6.0	161.0	7.0
12.7	6.0	164.0	10.0

Note: Burrs 12.0mm and above are available with an 8.0mm shank on request as a non-stock standard.



Edgehog® Carbide Burrs Series SE

Type E

Oval

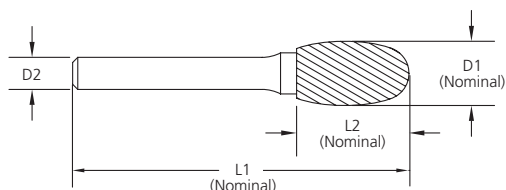

3mm Shank Burrs



Standard Cut Tool No.	Alt Diamond Tool No.	Fine Cut Tool No.	Shear Cut Tool No.	Tool Dimensions			
				D1	D2	L1	L2
SE-41M	SE-41M-D	SE-41M-F	-	3.0	3.0	38.0	5.6
SE-53M	SE-53M-D	-	-	4.8	3.0	38.0	7.0
SE-51M	SE-51M-D	SE-51M-F	-	6.4	3.0	48.0	9.5

6mm Shank Burrs



Standard Cut Tool No.	Alt Diamond Tool No.	Fine Cut Tool No.	Shear Cut Tool No.	Tool Dimensions			
				D1	D2	L1	L2
SE-1M	SE-1M-D	-	-	6.0	6.0	50.0	9.5
-	SE-2M-D	-	-	8.0	6.0	60.0	16.0
SE-3M	SE-3M-D	SE-3M-F	SE-3NFM	9.5	6.0	60.0	16.0
SE-5M	SE-5M-D	SE-5M-F	SE-5NFM	12.7	6.0	67.0	22.0
SE-6M	SE-6M-D	-	SE-6NFM	16.0	6.0	70.0	25.0
SE-7M	SE-7M-D	-	-	19.0	6.0	70.0	25.0



3mm Shank Burrs



Standard Cut Tool No.	Alt Diamond Tool No.	Fine Cut Tool No.	Shear Cut Tool No.	Tool Dimensions			
				D1	D2	L1	L2
SE-41L76M	-	-	-	3.0	3.0	76.0	5.6



6mm Shank Burrs



Standard Cut Tool No.	Alt Diamond Tool No.	Fine Cut Tool No.	Shear Cut Tool No.	Tool Dimensions			
				D1	D2	L1	L2
SE-3L6M	SE-3L6M-D	-	-	9.5	6.0	166.0	16.0
SE-5L6M	SE-5L6M-D	-	-	12.7	6.0	172.0	22.0

Note: Burrs 12.0mm and above are available with an 8.0mm shank on request as a non-stock standard.



Edgehog® Carbide Burrs Series SF



Type
F

Ball Nosed Tree

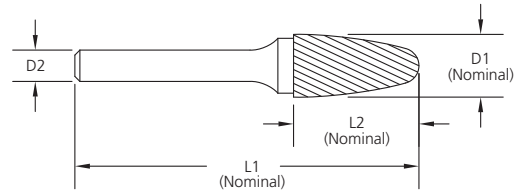

3mm Shank Burrs

				Tool Dimensions			
Standard Cut Tool No.	Alt Diamond Tool No.	Fine Cut Tool No.	Shear Cut Tool No.	D1	D2	L1	L2
SF-41M	SF-41M-D	SF-41M-F	-	3.0	3.0	38.0	6.0
SF-42M	SF-42M-D	SF-42M-F	-	3.0	3.0	38.0	12.7
SF-53M	SF-53M-D	SF-53M-F	-	4.8	3.0	38.0	12.7
SF-51M	SF-51M-D	SF-51M-F	-	6.4	3.0	51.0	12.7

6mm Shank Burrs

				Tool Dimensions			
Standard Cut Tool No.	Alt Diamond Tool No.	Standard Cut Tool No.	Alt Diamond Tool No.	D1	D2	L1	L2
SF-11M	SF-11M-D	SF-11M-F	-	3.0	6.0	50.0	12.7
SF-1M	SF-1M-D	SF-1M-F	-	6.0	6.0	50.0	16.0
SF-3M	SF-3M-D	-	SF-3NFM	9.5	6.0	64.0	19.0
SF-4M	SF-4M-D	-	-	11.0	6.0	70.0	25.0
SF-5MZ	SF-5MZ-D	SF-5MZ-F	-	12.0	6.0	70.0	25.0
SF-13M	SF-13M-D	SF-13M-F	-	12.7	6.0	64.0	19.0
SF-5M	SF-5M-D	SF-5M-F	SF-5NFM	12.7	6.0	70.0	25.0
SF-6M	SF-6M-D	SF-6M-F	SF-6NFM	16.0	6.0	70.0	25.0
SF-7M	SF-7M-D	SF-7M-F	-	19.0	6.0	70.0	25.0
SF-14M	SF-14M-D	-	-	19.0	6.0	76.0	31.0



3mm Shank Burrs

				Tool Dimensions			
Standard Cut Tool No.	Alt Diamond Tool No.	Fine Cut Tool No.	Shear Cut Tool No.	D1	D2	L1	L2
SF-42L76M	SF-42L76M-D	-	-	3.0	3.0	76.0	12.7



6mm Shank Burrs

				Tool Dimensions			
Standard Cut Tool No.	Alt Diamond Tool No.	Fine Cut Tool No.	Shear Cut Tool No.	D1	D2	L1	L2
SF-1L6M	SF-1L6M-D	SF-1L6M-F	-	6.0	6.0	166.0	16.0
SF-3L6M	SF-3L6M-D	-	-	9.5	6.0	169.0	19.0
SF-5L6M	SF-5L6M-D	-	-	12.7	6.0	175.0	25.0

Note: Burrs 12.0mm and above are available with an 8.0mm shank on request as a non-stock standard.



Edgehog® Carbide Burrs Series SG

Type G

Tree

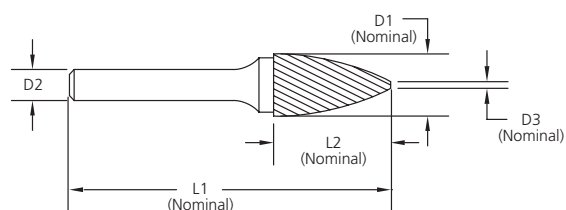

3mm Shank Burrs



Standard Cut Tool No.	Alt Diamond Tool No.	Fine Cut Tool No.	Shear Cut Tool No.	Tool Dimensions				
				D1	D2	L1	L2	D3
SG-41M	SG-41M-D	SG-41M-F	-	3.0	3.0	38.0	6.0	0.46
SG-42M	SG-42M-D	SG-42M-F	-	3.0	3.0	38.0	8.0	0.46
SG-43M	SG-43M-D	SG-43M-F	-	3.0	3.0	38.0	9.5	0.46
SG-53M	SG-53M-D	SG-53M-F	-	4.8	3.0	38.0	12.7	0.64
SG-51M	SG-51M-D	SG-51M-F	-	6.4	3.0	51.0	12.7	0.76

6mm Shank Burrs



Standard Cut Tool No.	Alt Diamond Tool No.	Fine Cut Tool No.	Shear Cut Tool No.	Tool Dimensions				
				D1	D2	L1	L2	D3
SG-1M	SG-1M-D	SG-1M-F	-	6.0	6.0	50.0	16.0	0.76
SG-2M	SG-2M-D	SG-2M-F	-	8.0	6.0	64.0	19.0	1.02
SG-3M	SG-3M-D	SG-3M-F	-	9.5	6.0	64.0	19.0	1.02
SG-3MZ	SG-3MZ-D	SG-3MZ-F	-	10.0	6.0	65.0	20.0	1.14
SG-5MZ	SG-5MZ-D	SG-5MZ-F	-	12.0	6.0	70.0	25.0	1.27
SG-13M	SG-13M-D	SG-13M-F	-	12.7	6.0	64.0	19.0	1.27
SG-5M	SG-5M-D	SG-5M-F	-	12.7	6.0	70.0	25.0	1.27
SG-6M	SG-6M-D	SG-6M-F	-	16.0	6.0	70.0	25.0	1.27
SG-7M	SG-7M-D	SG-7M-F	-	19.0	6.0	70.0	25.0	1.27
SG-15M	SG-15M-D	SG-15M-F	-	19.0	6.0	84.0	38.0	1.78



3mm Shank Burrs



Standard Cut Tool No.	Alt Diamond Tool No.	Fine Cut Tool No.	Shear Cut Tool No.	Tool Dimensions				
				D1	D2	L1	L2	D3
SG-42L76M	SG-42L76M-D	-	-	3.0	3.0	76.0	8.0	0.46
SG-43L76M	SG-43L76M-D	-	-	3.0	3.0	76.0	9.5	0.46



6mm Shank Burrs



Standard Cut Tool No.	Alt Diamond Tool No.	Fine Cut Tool No.	Shear Cut Tool No.	Tool Dimensions				
				D1	D2	L1	L2	D3
SG-1L6M	SG-1L6M-D	SG-1L6M-F	-	6.0	6.0	166.0	16.0	0.76
-	SG-3L6M-D	SG-3L6M-F	-	9.5	6.0	169.0	19.0	1.02
-	SG-5L6M-D	SG-5L6M-F	-	12.7	6.0	175.0	25.0	1.27

Note: Burrs 12.0mm and above are available with an 8.0mm shank on request as a non-stock standard.



Edgehog® Carbide Burrs Series SH



Type
H

Flame

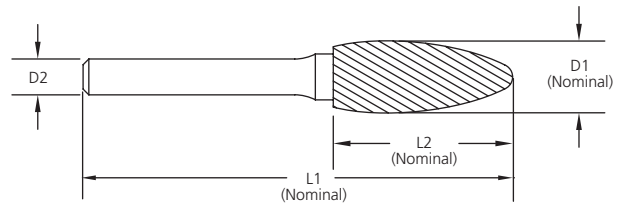
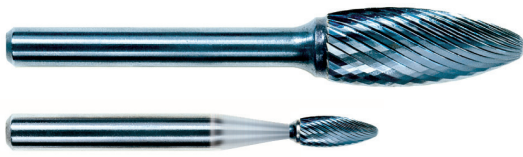

3mm Shank Burrs



Standard Cut Tool No.	Alt Diamond Tool No.	Fine Cut Tool No.	Shear Cut Tool No.
SH-41M	SH-41M-D	SH-41M-F	-
SH-53M	SH-53M-D	SH-53M-F	-

Tool Dimensions			
D1	D2	L1	L2
3.0	3.0	38.0	6.0
4.8	3.0	38.0	9.5

6mm Shank Burrs

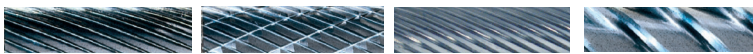

Standard Cut Tool No.	Alt Diamond Tool No.	Fine Cut Tool No.	Shear Cut Tool No.
SH-1M	SH-1M-D	SH-1M-F	-
SH-2M	SH-2M-D	SH-2M-F	-
SH-5M	SH-5M-D	SH-5M-F	-
SH-6M	SH-6M-D	SH-6M-F	-
SH-7M	SH-7M-D	SH-7M-F	-

Tool Dimensions			
D1	D2	L1	L2
6.0	6.0	50.0	16.0
8.0	6.0	64.0	19.0
12.7	6.0	76.0	31.0
16.0	6.0	81.0	36.0
19.0	6.0	86.0	41.0



3mm Shank Burrs



Standard Cut Tool No.	Alt Diamond Tool No.	Fine Cut Tool No.	Shear Cut Tool No.
SH-41L76M	SH-41L76M-D	-	-

Tool Dimensions			
D1	D2	L1	L2
3.0	3.0	76.0	6.0



6mm Shank Burrs



Standard Cut Tool No.	Alt Diamond Tool No.	Standard Cut Tool No.	Alt Diamond Tool No.
SH-2L6M	SH-2L6M-D	SH-2L6M-F	-
SH-5L6M	SH-5L6M-D	SH-5L6M-F	-

Tool Dimensions			
D1	D2	L1	L2
8.0	6.0	169.0	19.0
12.7	6.0	181.0	31.0

Note: Burrs 12.0mm and above are available with an 8.0mm shank on request as a non-stock standard.



Edgehog® Carbide Burrs Series SJ



Type
J

Countersink 60°

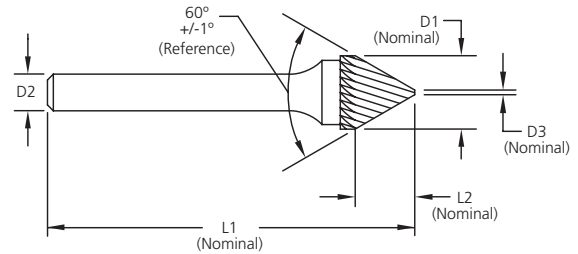
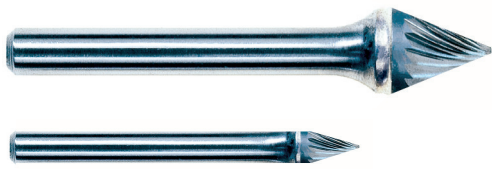

3mm Shank Burrs

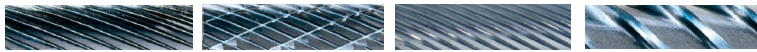

Standard Cut Tool No.	Alt Diamond Tool No.	Fine Cut Tool No.	Shear Cut Tool No.	Tool Dimensions			
				D1	D2	L1	L2
SJ-42M	SJ-42M-D	SJ-42M-F	-	3.0	3.0	38.0	2.4
-	SJ-82M-D*	-	-	3.0	3.0	38.0	2.4

* SJ-82M-D is double ended

6mm Shank Burrs

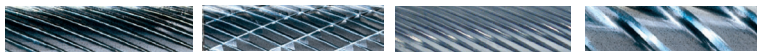

Standard Cut Tool No.	Alt Diamond Tool No.	Fine Cut Tool No.	Shear Cut Tool No.	Tool Dimensions			
				D1	D2	L1	L2
SJ-1M	SJ-1M-D	-	-	6.0	6.0	50.0	4.8
SJ-3M	SJ-3M-D	-	-	9.5	6.0	55.0	8.0
SJ-5M	SJ-5M-D	-	-	12.7	6.0	58.0	11.0
SJ-6M	SJ-6M-D	-	-	16.0	6.0	62.0	12.7
SJ-7M	SJ-7M-D	-	-	19.0	6.0	64.0	14.0
SJ-9M	SJ-9M-D	-	-	25.0	6.0	70.0	21.0

Note: Burrs 12.0mm and above are available with an 8.0mm shank on request as a non-stock standard.



FORDMAX

Burrs
 Fraises Limes
 Frässtifte
 Lime Rotative
 Zadziozy

Edgehog® Carbide Burrs Series SK



Type K

Countersink 90°

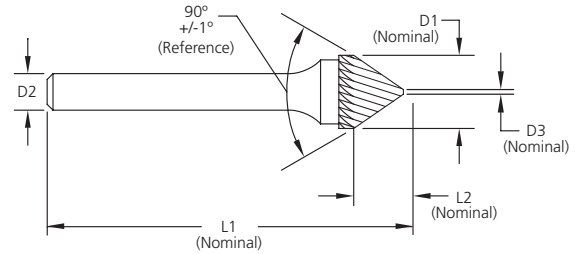
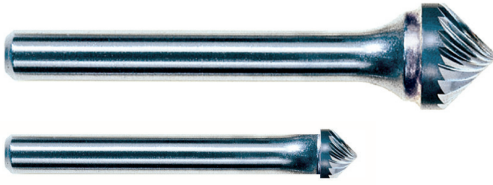

3mm Shank Burrs

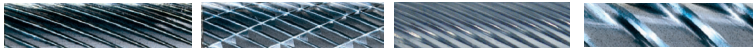

Standard Cut Tool No.	Alt Diamond Tool No.	Fine Cut Tool No.	Shear Cut Tool No.	Tool Dimensions			
				D1	D2	L1	L2
SK-42M	SK-42M-D	-	-	3.0	3.0	38.0	1.6
SK-82M*	SK-82M-D*	-	-	3.0	3.0	38.0	1.6

* SK-82M is double ended

6mm Shank Burrs

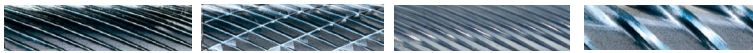

Standard Cut Tool No.	Alt Diamond Tool No.	Fine Cut Tool No.	Shear Cut Tool No.	Tool Dimensions			
				D1	D2	L1	L2
SK-1M	SK-1M-D	-	-	6.0	6.0	50.0	3.0
SK-3M	SK-3M-D	-	-	9.5	6.0	52.0	4.8
SK-5M	SK-5M-D	-	-	12.7	6.0	53.0	6.4
SK-6M	SK-6M-D	-	-	16.0	6.0	56.0	8.0
SK-7M	SK-7M-D	-	-	19.0	6.0	58.0	9.5
SK-9M	SK-9M-D	-	-	25.0	6.0	61.0	12.7

Note: Burrs 12.0mm and above are available with an 8.0mm shank on request as a non-stock standard.



FORDMAX

Burrs
Fraises Limes
Frässtifte
Lime Rotative
Zadziorzy

Edgehog® Carbide Burrs Series SL

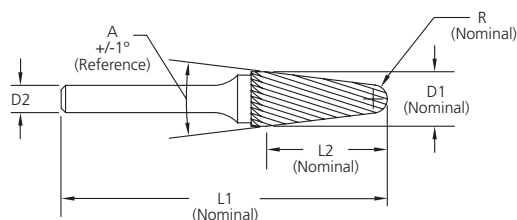
Type L
Ball Nosed Cone

3mm Shank Burrs



				Tool Dimensions				
Standard Cut Tool No.	Alt Diamond Tool No.	Fine Cut Tool No.	Shear Cut Tool No.	D1	D2	L1	L2	A°
SL-41M	SL-41M-D	SL-41M-F	-	3.0	3.0	38.0	9.5	8°
SL-42M	SL-42M-D	SL-42M-F	-	3.0	3.0	38.0	12.7	8°
SL-53M	SL-53M-D	SL-53M-F	-	4.8	3.0	38.0	12.7	14°

6mm Shank Burrs



				Tool Dimensions				
Standard Cut Tool No.	Alt Diamond Tool No.	Fine Cut Tool No.	Shear Cut Tool No.	D1	D2	L1	L2	A°
SL-1M	SL-1M-D	SL-1M-F	-	6.0	6.0	50.0	16.0	14°
SL-2M	SL-2M-D	SL-2M-F	-	8.0	6.0	71.0	24.0	14°
SL-3M	SL-3M-D	SL-3M-F	SL-3NFM	9.5	6.0	75.0	28.0	14°
SL-4M	SL-4M-D	SL-4M-F	SL-4NFM	12.7	6.0	76.0	30.0	14°
-	SL-6M-D	SL-6M-F	SL-6NFM	16.0	6.0	80.0	33.0	14°
SL-7M	SL-7M-D	SL-7M-F	-	19.0	6.0	86.0	39.0	14°



3mm Shank Burrs



				Tool Dimensions				
Standard Cut Tool No.	Alt Diamond Tool No.	Fine Cut Tool No.	Shear Cut Tool No.	D1	D2	L1	L2	A°
SL-42L76M	SL-42L76M-D	-	-	3.0	3.0	76.0	12.7	8°



6mm Shank Burrs



				Tool Dimensions				
Standard Cut Tool No.	Alt Diamond Tool No.	Fine Cut Tool No.	Shear Cut Tool No.	D1	D2	L1	L2	A°
-	-	SL-2L6M-F	-	8.0	6.0	176.0	24.0	14°
SL-3L6M	SL-3L6M-D	SL-3L6M-F	-	9.5	6.0	180.0	28.0	14°
SL-4L6M	SL-4L6M-D	SL-4L6M-F	-	12.7	6.0	182.0	30.0	14°

Note: Burrs 12.0mm and above are available with an 8.0mm shank on request as a non-stock standard.



Edgehog® Carbide Burrs Series SM



Type
M

Cone

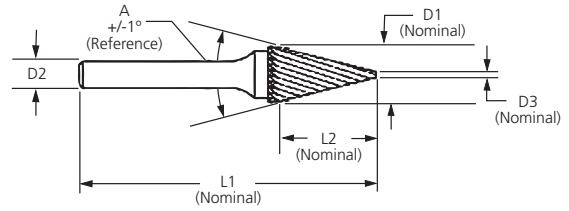

3mm Shank Burrs



Standard Cut Tool No.	Alt Diamond Tool No.	Fine Cut Tool No.	Shear Cut Tool No.	Tool Dimensions					
				D1	D2	L1	L2	A°	D ³
SM-45M	SM-45M-D	SM-45M-F	-	3.0	3.0	38.0	4.8	32°	0.46
SM-41M	SM-41M-D	SM-41M-F	-	3.0	3.0	38.0	9.5	12°	1.09
SM-42M	SM-42M-D	SM-42M-F	-	3.0	3.0	38.0	11.1	14°	0.36
SM-43M	SM-43M-D	SM-43M-F	-	3.0	3.0	38.0	16.0	7°	1.14
SM-53M	SM-53M-D	SM-53M-F	-	4.8	3.0	38.0	12.7	16°	0.97
SM-51M	SM-51M-D	SM-51M-F	-	6.4	3.0	54.0	12.7	22°	1.32

6mm Shank Burrs

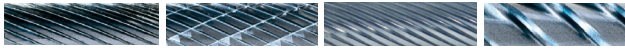

Standard Cut Tool No.	Alt Diamond Tool No.	Fine Cut Tool No.	Shear Cut Tool No.	Tool Dimensions					
				D1	D2	L1	L2	A°	D ³
SM-1M	SM-1M-D	SM-1M-F	-	6.0	6.0	50.0	12.7	22°	1.17
SM-2M	SM-2M-D	SM-2M-F	-	6.0	6.0	50.0	19.0	14°	1.42
SM-3M	SM-3M-D	SM-3M-F	-	6.0	6.0	50.0	25.0	10°	1.65
SM-4M	SM-4M-D	SM-4M-F	-	9.5	6.0	63.0	16.0	28°	1.32
SM-5M	SM-5M-D	SM-5M-F	-	12.7	6.0	69.0	22.0	28°	1.32
SM-6M	SM-6M-D	SM-6M-F	-	16.0	6.0	72.0	25.0	31°	1.52



3mm Shank Burrs

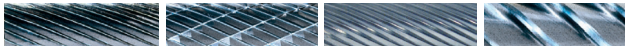

Standard Cut Tool No.	Alt Diamond Tool No.	Fine Cut Tool No.	Shear Cut Tool No.	Tool Dimensions					
				D1	D2	L1	L2	A°	D ³
SM-42L76M	SM-42L76M-D	-	-	3.0	3.0	76.0	11.0	14°	0.36

Note: Burrs 12.0mm and above are available with an 8.0mm shank on request as a non-stock standard.



Edgehog® Carbide Burrs Series SN

Type N

Inverted Cone

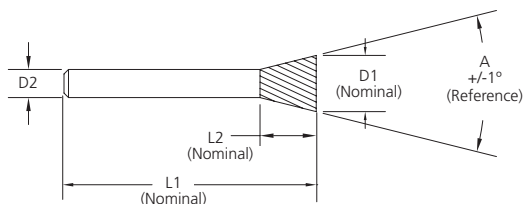

3mm Shank Burrs



				Tool Dimensions				
Standard Cut Tool No.	Alt Diamond Tool No.	Fine Cut Tool No.	Shear Cut Tool No.	D1	D2	L1	L2	A°
SN-41M	SN-41M-D	SN-41M-F	-	2.4	3.0	38.0	3.0	10°
SN-42M	SN-42M-D	SN-42M-F	-	3.0	3.0	38.0	4.8	10°
SN-53M	SN-53M-D	SN-53M-F	-	4.8	3.0	38.0	6.4	10°
SN-51M	SN-51M-D	SN-51M-F	-	6.4	3.0	44.0	6.4	10°

6mm Shank Burrs



				Tool Dimensions				
Standard Cut Tool No.	Alt Diamond Tool No.	Fine Cut Tool No.	Shear Cut Tool No.	D1	D2	L1	L2	A°
-	SN-1M-D	SN-1M-F	-	6.0	6.0	50.0	8.0	10°
SN-2M	SN-2M-D	SN-2M-F	-	9.5	6.0	55.0	9.5	13°
SN-4M	SN-4M-D	SN-4M-F	-	12.7	6.0	58.0	12.7	28°
SN-6M	SN-6M-D	SN-6M-F	-	16.0	6.0	64.0	19.0	18°
-	SN-7M-D	SN-7M-F	-	19.0	6.0	61.0	16.0	30°

FORDMAX

 Burrs
 Fraises Limes
 Frässtifte
 Lime Rotative
 Zadziozy

Edgehog® Carbide Burrs

Burr Fluting Chart

Tableau de denture par fraise
Tabelle der Fräuserschneiden
Numero di taglienti
Tabela pilników obrotowych

Number Of Flutes (± 10%)			
Burr Ø	Standard Cut	Fine Cut	Shear Cut
1.6	10	12	-
2.0	10	12	-
2.4	12	16	-
3.0	12	20	-
4.0	14	24	-
4.8	15	24	-
6.0	16	25	-
8.0	18	30	-
9.5	20	30	6
11.0	22	30	-
12.7	24	35	8*
16.0	26	40	8**
19.0	30	40	-
25.0	35	45	-

* Except SL-4NFM - 6 Flutes

** Except SD-6NFM, SE-6NFM and SF-6NFM - 10 Flutes.

Alternate Diamond Grind - LH Fluting 40% of RH Fluting
Diamond Grind - LH Fluting 80% of RH Fluting.

Recommended Operating Speeds

Vitesses d'utilisation recommandées
Empfohlene Betriebsdrehzahlen
Velocità di utilizzo consigliate
Zalecane prędkości pracy

Burr Diameter Ø mm	Operating Speed RPM	
	From	To
3.0	45,000	90,000
6.0	23,000	45,000
9.5	19,000	30,000
12.7	15,000	22,000
16.0	12,000	18,000
19.0	7,500	15,000

The speed guidelines above are general recommendations.
Speeds may require adjusting based on material and application.

Burr Application By Material

Type de denture de fraises par matière
Frässtift-Anwendungsgebiete nach Material
Scelta dell'utensile in funzione del materiale
Zastosowanie frezu (pilnika obrotowego) według materiału

Material	Standard Cut	Alt Diamond Cut	Fine Cut	Shear Cut
Aluminium	•	•	-	•
Brass, Bronze, Copper	•	•	-	-
Carbon	•	-	-	-
Cast Iron	•	-	-	-
Fibreglass	•	-	-	-
Hard Rubber	•	-	-	•
Magnesium	-	-	-	•
Masonite	•	-	-	•
Plastics	•	-	-	•
Steels - 40-60HRc	•	•	•	-
Steels, Alloy Steels	•	•	-	-
Nickel/Chrome Steels	•	•	-	-
Stainless Steels	•	•	•	-
Steel Weldments	•	•	-	-
Titanium	•	•	-	-
Wood	-	-	-	•
Zinc	-	-	-	•

Edgehog® Carbide Burrs

Problems and Solutions | Problèmes et Solutions | Probleme und Lösungen | Problemi e Soluzioni | Problemy i Rozwiązania

Possible Causes | Causes Possibles | Mögliche Ursachen | Cause Possibili | Możliwe Przyczyny

Problem	Possible Causes Causes Possibles Mögliche Ursachen Cause Possibili Możliwe Przyczyny									
	Excessive Force	Shank Friction With Workpiece	Worn Burr	Incorrect Collet Location	Worn Grinder Bearings	Poor Shank Straightness	Unstable Workpiece	Working in Soft Materials	Cutting Abrasive Material	Low Setup Rigidity
Broken Brazed Joint	●	●	●	-	-	-	-	-	-	-
Poor Burr Control	-	-	-	●	●	●	●	-	-	●
Flutes Clogging	-	-	-	-	-	-	-	●	-	-
Excessive Vibration	-	-	-	●	●	●	●	-	-	●
Poor Finish	-	-	-	●	●	●	●	●	-	●
Poor Tool Life	-	●	-	●	●	●	●	-	●	●

Possible Causes | Causes Possibles | Mögliche Ursachen | Cause Possibili | Możliwe Przyczyny







Problem	Possible Causes Causes Possibles Mögliche Ursachen Cause Possibili Możliwe Przyczyny							
	Reduce Cutting Pressure	Ensure Shank / Workpiece Clearance	Replace Worn Burr	Check Burr Location & Replace Collet if Necessary	Check & Replace Grinder Bearings if Necessary	Check Shank Straightness - Replace Burr if Necessary	Improve Workpiece Stability	Use a Coarser Cut Burr
Broken Brazed Joint	●	●	●	-	-	-	-	-
Poor Burr Control	-	-	-	●	●	●	●	-
Flutes Clogging	-	-	-	-	-	-	-	●
Excessive Vibration	-	-	-	●	●	●	●	-
Poor Finish	-	-	-	●	●	●	●	-
Poor Tool Life	-	●	-	●	●	●	-	-

Possible Causes | Causes Possibles | Mögliche Ursachen | Cause Possibili | Możliwe Przyczyny

Problem	Possible Causes Causes Possibles Mögliche Ursachen Cause Possibili Możliwe Przyczyny						
	Use Lubricant or Anti-Sticking Agent	Increase RPM	Reduce RPM	Make Lighter Cuts	Change to a Finer Cut Burr	Faster Feed	Slower Feed
Broken Brazed Joint	-	-	-	-	-	-	-
Poor Burr Control	-	-	-	-	-	-	-
Flutes Clogging	●	●	●	●	-	-	-
Excessive Vibration	-	●	●	-	-	●	●
Poor Finish	-	●	●	-	●	●	●
Poor Tool Life	●	-	●	-	●	●	●

Material cross reference chart

Tableau de correspondance des matières : Tabelle mit Materialbezeichnungen
 Tabella di comparazione dei materiali : Tabela materiałóv

							
	UK	German DIN	French	Swedish	Spanish	USA	
FREE MACHINING STEEL	1.0718	9SMnPb28	S250Pb	1914	F.2112 - 11SMnPb28	12L13	
	210M15	1.0721	10S20	10F1		F.2121 - 10 S 20	
	210A15	1.0723	15S20		1922	F.210F	
	240M07	1.0736	9SMn36	S300		F.2113- 12 SMn 35	
		1.0737	9MnPb36	S300Pb	1926	F.2114 - 12 SMnPb 35	
	1.7022	10SPb20	10PbF2		F.2122 - 10 SPb 20	1108	
LOW CARBON STEEL	045M10	1.0301	C10	AF34C10/XC10		1010	
	080M15;040A15	1.0401	C15	AF37C12/XC18	1350	F.111	
	050A20/055M15	1.0402	C22	AF42C20/XC25	1450	F.112	
	070M26	1.0406	C25	AF50C30		F.221	
	220M07	1.0711	9S20				
	230M07	1.0715	9SMn28	S250	1912	F.2111 - 11SMn28	
	040A10	1.1121	Ck10	XC10	1265	F.1510 - C 10 k	
	120M19	1.1133	20Mn5	20M5		F.1515 - 20 Mn 6	
	080M15	1.1141	Ck15	XC15 / C15E	1370	F.1511 - C 16 k	
	050A20	1.1151	Ck22	XC25 / C22E		F.1120 - C 25 k	
	070M26	1.1158	Ck25	XC25 / C25E		F.1120 - C 25 k	
		1.5419	22Mo4				4419
		1.5622	14Ni6	15N6 / 15Ni6		F.2641 - 15 Ni 6	A350-LF5
	655M13/A12	1.5752	14NiCr14	12NC15			3310/9314
	523M15	1.7015	15Cr3	12C3			5015
STRUCTURAL STEEL	4360-40C	1.0038	RSt37-2	E24-2NE / S235JRG2	1312		
	4360-43B	1.0044	St44-2	E28-2 / S275JR	1412	A 430B	
	4360-50B	1.005	St50-2	A50-2 / E295	2172		
	4360-55E	1.006	St60-2	A60-2 / E355			
	4360-40C/D-1449-37C	1.0116	St37-3	E24-3;-4 / S235J2G3	1313	A360 C;D	
	1449 -2/3/4CR	1.033	St12	DC01		AP 00	
	1449 2CR; 3CR	1.0333	St13			AP 02	
	1449 1CR; 2CR	1.0338	St14	DC04		AP 04	
	1501Gr.161-360/400	1.0345	H I	A37CP;AP / P235GH	1330	A 37 RC I;RA II	
	3CR	1.0347	RRSt13	DC03			
	161-400;	1.0425	H II	A42CP;AP / P265GH	1430	A42 RC I	
		1.0473	19Mn6	A52CP;AP / P335GH	2101/2102	A 47 RB II	
		1.0481	17Mn4	A48CP;AP / P295GH		A 47 RC I; RA II	
		1.0562	StE355	E355R/FP / S355N	2132	AE 355 KG; DD	
	4360-50B;50C;50D	1.057	St52-3	E36-3;E36-4 / S355J2G3	2132	A 510 C;D	
	1501-240	1.5415	15Mo3	15D3 / 15Mo3	2912	F.2601 - 16 Mo 3	
	1503-245-420	1.5423	16Mo5			F.2602 - 16 Mo 5	
	1501-503-690	1.5637	10Ni14	12N14 / 12Ni14		F.152	
		1.5713	13NiCr6	10NC6			
		1.5732	14NiCr10	14NC11		F.1540 - 15 NiCr 11	
	620Gr.27;31	1.7335	13CrMo44	15CD3.05	2216	F.2631 - 14 CrMo 4 5	
	4360-55E	1.8902	StE420	E420RIFP / S420N		AE 420 KG	
		1.8905	StE460	E460RIFP / S460N		AE 460 KG	
		1.007	St70-2	A70-2 / E360			
	620Gr.27	1.7337	16CrMo44	15CD4.5	2216		
622Gr.31;45	1.738	10CrMo910	12CD9.10 / 10CrMo9-10	2218	TU.H		
660/440	1.7715	14MoV63			F.2621 - 13 MoCrV6		
MEDIUM CARBON STEEL	060A35	1.0501	C35	AF55C35 /XC38	1550	F.113	
	212M36	1.0726	35S20	35MF6	1957	F.210G.	
	120M36/150M28	1.1165	30Mn5	35M5 / 30Mn5		F.1203 - 36 Mn5	
		1.1166	34Mn5	35M5 / 34Mn5		F.8211 - 30 Mn5	
	150M36	1.1167	36Mn5	40M5 / 36Mn5	2120	F.1203 - 36 Mn5	
	150M28	1.117	28Mn6	20M5 / 28Mn6			
	080M36	1.118	Cm35	XC32 / C35R	1572	F.1135 - C 35 k-1	
	080M36	1.1181	Ck35	XC38H1 / C35E	1572	F.1130 - C 35 k	
	060A35	1.1183	Cf35	XC38H1TS	1572		
	080M46	1.0503	C45	AF65C45 /C45	1650	F.114	
	070M55	1.0535	C55	C55	1655		
	080A62	1.0601	C60	AF70C55 / C60		F.115	
	070A72	1.0605	C75	C75			
	212M44	1.0727	45S20	45MF4	1973		
	250A53	1.0903	51Si7	51S7	2090	F.1450 - 50 Si 7	
	250A53	1.0904	55Si7	55S7	2085	F.1440- 56 Si 7	
	150M36	1.1157	40Mn4	35M5			
	060A40/080A40	1.1186	Ck40	XC42H1 / C40E			
	080M46/060A47	1.1191	Ck45	XC42H1 / C45/XC45	1672	F.1140 - C 45 k	
	060A47	1.1193	Cf45	XC42H1TS	1672		
	080M46	1.1201	Cm45	XC42H1 /C45R	1660	F.1145 - C 45 k	
	060A57/070M55	1.1203	Ck55	XC55H1 / C55E		F.1150 - C 55 k	
	080M50	1.1206	Ck50	XC48H1 / C50E			
	070M55	1.1209	Cm55	XC55H1 / C55R / 3C55		F.1150 - C 55 k	
	060A52	1.1213	Cf53	XC48H1TS	1674		
	060A62	1.1221	Ck60	XC60 / C60E/2C60	1665/1678	F.511/F.512	
	060A67	1.1231	Ck67	XC68	1770		
	250A58	1.0909	60Si7	60S7		F.1441 - 60 Si 7	
	250A61	1.0961	60SiCr7	60SC7		F.1442 - 60 SiCr 8	

Material cross reference chart

Tableau de correspondance des matières | Tabelle mit Materialbezeichnungen
Tabella di comparazione dei materiali | Tabela materialów

	UK	German DIN	French	Swedish	Spanish	USA	
ALLOY STEEL	805M20	1.6523	21NiCrMo2	20NCD2	2506	F.1522 - 20 NiCrMo 2	8620
	805A20	1.6543	21NiCrMo22			F.1534 - 20 NiCrMo 3	8720
	060A78	1.1248	Ck75	XC75 / C75E	1774/1778	F.513/514/515	1080/1078
	640A35	1.571	36NiCr6	35NC6			3135
	640M40	1.5711	40NiCr6				3140
	311-Type7	1.6546	40NiCrMo22	40NCD2		F.1204 - 40 NiCrMo2	8740
	820A16	1.6587	17CrNiMo8	18NCD6		F.1560 - 14 NiCrMo13	
	832M13	1.6657	14NiCrMo134	16NCD13		F.1569 - 14 NiCrMo 131	
		1.7006	46Cr2	42C2 / 46Cr2			5045/5046
	530A32	1.7033	34Cr4	32C4 / 34Cr4		F.8221 - 35 Cr 4/F.224	5132
	530A36	1.7034	37Cr4	38C4 / 37Cr4		F.1201 - 38 Cr 4	5135
	527M17	1.7131	16MnCr5	16MC5	2511	F.1515 - 16 MnCr 5	5115
		1.7147	20MnCr5	20MC5		F.150.D	5120
	1717CDS110	1.7218	25CrMo4	25CD4 / 25CrMo4	2225	F.8330 - AM 25 CrMo4	4130
	905M31	1.8507	34CrAlMo5	30CAD6.12		F.1741 - 34 CrAlMo5	A355Cl.D
	905M39	1.8509	41CrAlMo7	40CAD6.12	2940	F.1740 - 41 CrAlMo7	A355Cl.A
	708A37	1.233	35CrMo4	34CD4 / 35CrMo4	2234		4135
	708M40	1.2332	47CrMo4	42CD4	2244		4142
	530M40/530A40	1.7035	41Cr4	42C4 / 41Cr4		F.1202 -42 Cr4	5140
	530A40	1.7045	42Cr4	42C4TS	2245	F.1202 - 42 Cr 4	5140
	527A60	1.7176	55Cr3	55C3	2253	F.1431 - 55 Cr3	5155
	708A37	1.722	34CrMo4	35CD4 / 34CrMo4	2234	F.8231 - AM 34 CrMo4	4135/4137
	708M40	1.7223	41CrMo4	42CD4TS	2244	F.8232 - 42 CrMo4	4142/4140
	708M40	1.7225	42CrMo4	42CD4 / 42CrMo4	2244	F.8232 - 42 CrMo4	4140
	708A47	1.7228	50CrMo4	50CrMo4			4150
	735A50	1.8159	50CrV4	50CV4 / 51CrV4	2230	F.1430 - 51 CrV4	6150
	060A96	1.1274	Ck101	XC100	1870		1095
	HIGH STRENGTH ALLOY STEEL	816M40	1.6511	36CrNiMo4	40NCD3 / 36CrNiMo4		F.1280 - 35 NiCrMo4
817M40		1.6562	40NiCrMo73				4340
311-Type6		1.6565	40NiCrMo6			F.1272 - 40 NiCrMo 7	4340
823M30		1.658	30CrNiMo8	30CND8 / 30CrNiMo8			
817M40		1.6582	34CrNiMo8	35NCD6 / 34CrNiMo6	2541	F.1272 - 40 NiCrMo 7	4340
830M31		1.6746	32NiCrMo145	35NCD14		F.1262 - 32 NiCrMo 12	
835M30		1.6747	30NiCrMo166	35NCD16		F.1260 - 32 NiCrMo16	
722M24		1.8515	31CrMoV139	30CD12	2240	F.1712 - 31 CrMo 12	
722M24		1.7361	32CrMo12	30CD12	2240	F.124.A	
TOOL STEELS			1.1525	C80W1	Y190;Y180		
		1.1545	C105W1	Y1105	1880		W110
	BW1B	1.1625	C80W2			F.1507 C80	W1
		1.1663	C125W	Y2120		F.5123 C120	W112
	BW1A	1.175	C75W				W1
	BL3	1.2067	100Cr6	Y100C6		F.5230 100 Cr6	L3
		1.221	115CrV3				L2
	BO1	1.251	100MnCrW4		2140	F.5220 95 MnCrW5	O1
	BS1	1.2542	45WCrV7		2710	F.5241 45 WCrSi 8	S1
	BW2	1.2833	100V1	Y1105V			W210
	BO2	1.2842	90MnCrV8	90MV8			2
	534A99	1.3505	100Cr6	100C6	2258	F.1310 - 100 Cr 6	52100
		1.2713	55NiCrMoV6	55NCDV7		F.528	L6
	Grade2A	0.962	G-X260NiCr42				A532IBNiCr-LC
	Grade2B	0.9625	G-X330NiCr42				A532IANiCr-HC
	Grade2C;D;E	0.963	G-X300CrNiSi952				A532IDNi-HiCr
	Grade3A;B	0.964	G-X300CrMoNi1521				
	Grade3C	0.9645	G-X260CrMoNi2021				A532IID20%CrMo-LC
	Grade3D	0.965	G-X260Cr27				A532IIIA25%Cr
	Grade3E	0.9655	G-X300CrMo271				A532IIIA25%Cr
	BD3	1.208	X210Cr12	Z200C12		F.5212 X210 Cr12	D3
	BH11	1.2343	X38CrMoV51	Z38CDV5		F.5317 X37 CrMoV5	H11
	BH13	1.2344	X40CrMoV51	Z40CDV5	2242	F.5318 X40 CrMoV5	H13
	BA2	1.2363	X100CrMoV51	Z100CDV5	2260	F.5227 X100 CrMoV5	A2
	BH10	1.2365	X32CrMoV33	32DCV28		F.5313 CrMoV 12	H10
	BD2	1.2379	X155CrVMo121	Z160CDV12			D2
		1.2436	X210CrW12		2312	F.5213 X210 CrW12	
		1.2567	X30WCrV53	Z32WCV5			
	BH21	1.2581	X30WCrV93	Z30WCV9		F.5323 X30 WCrV9	H21
		1.2601	X165CrMoV12		2310	F.5211 X160 CrMoV12	
	BH12	1.2606	X37CrMoW51	Z35CWDV5			H12
	BT15	1.3202	S12-1-4-5			F.5563 12-1-5-5	T15
		1.3207	S10-4-3-10	Z130WKCDV10-10-04-03		F.553 10-4-3-10	
		1.3243	S6-5-2-5	Z85WDKCV06-05-05-04-02	2723	F.5613 6-5-2-5	
		1.3246	S7-4-2-5	Z110WKCDV07-05-04-04-02		F.5613 6-5-2-5	M41
	BT42	1.3247	S2-10-1-8	Z110DKCWW09-08-04-02-01		F.5615 7-4-2-5	M42
	BM34	1.3249	S2-9-2-8			F.5611 2-9-2-8	M33/M34
	BT4	1.3255	S18-1-2-5	Z80WKCV18-05-04-01		F.5530 18-1-1-5	T4
BT5	1.3265	S18-1-2-10			F.5540 18-0-2-10	T5	
	1.3342	SC6-5-2	Z90WDCV06-05-04-03			M3	
BM2	1.3343	S6-5-2	Z85WDCV06-05-04-02	2722	F.5603 6-5-2	M2	

Material cross reference chart

Tableau de correspondance des matières : Tabelle mit Materialbezeichnungen
 Tabella di comparazione dei materiali : Tabela materiałóv

	UK	German	DIN	French	Swedish	Spanish	USA
TOOL STEELS		1.3344	S6-5-3	Z130WDCV06-05-04-04		F.5605 6-5-3	M3Class2
	BM1	1.3346	S2-9-1	Z85DCWV08-04-02-01			H41/M1
		1.3348	S2-9-2	Z100DCWV09-04-02-02	2782	F.5607 2-9-2	M7
	BT1	1.3355	S18-0-1	Z80WCV18-04-01		F.5520 18-0-1	T1
		1.3401	X120Mn12	Z120M12 / Z120Mn12		F.82551-AM-X 120 Mn 12	A128(A)
STAINLESS STEEL	443S65	1.4747	X80CrNiSi20	Z80CSN20.02		F.3222-X 80CrSiNi20-02	HNV6
	403S17	1.4	X6Cr13	Z6013 / Z6Cr13	2301	F.3110-X6 Cr 13	403
	403S17	1.4001	X7Cr14	Z3014	2301	F.8401-AM-X12 Cr 13	410S
	405S17	1.4002	X6CrAl13	Z6CA13 / Z6CrAl13	2302	F.3111-X6 CrAl13	405
	416S21	1.4005	X12Cr513	Z12CF13 / Z12Cr513	2380	F.3411-X12 CrS13	416
	410S21	1.4006	X10Cr13	Z12C13 / Z12Cr13	2302	F.3401-X12 Cr 13	410/CA-15
	410C21	1.4008	G-X8Cr14	Z12CN13M			410
	430S15	1.4016	X6Cr17	Z8C17 / Z6Cr17	2320	F.3113-X8 Cr17	430
	420S37	1.4021	X20Cr13	Z20C13 / Z20Cr13	2303	F.3402-X20 Cr 13	420
	420S45	1.4028	X30Cr13	Z20C13 / Z20Cr13	2304	F.3403-X30 Cr 13	420
		1.4031	X38Cr13	Z40C14 / Z40Cr14	2304	F.3404-X40 Cr 13	
	420S45	1.4034	X46Cr13	Z40C14 / Z40Cr14		F.3405-X46 Cr 13	420
	431S29	1.4057	X20CrNi172	Z15CN16.02	2321	F.3427-X15 CrNi16	431
		1.4104	X12CrMoS17	Z10CF17	2383	F.3117-X10 CrS17	430F
	434S17	1.4113	X6CrMo17	Z8CD17.01	2325		434
		1.4125	X105CrMo17	Z100CD17			440C
		1.451	X6CrTi17	Z8CT17		F.3114-X8CrTi17	XM8/430Ti
	409S19	1.4512	X5CrTi12	Z6CT12			409
		1.4534					13-8 PH Mo
		1.4545					15-5 PH
							15-7 PH Mo
		1.4504					17-4 PH
		1.4548		Z7CNU17-04			17-4 PH ,CH900
	401S45	1.4718	X45CrSi93	Z45CS9		F.3220-X 4 CrSi 09-03	HNV3
	403S17	1.4724	X10CrAl13	Z10C13		F.13152-X 10 CrAl13	
		1.4731	X40CrSiMo102	Z40CSD10		F.3221-X 40 CrSiMo 10-02	
	430S15	1.4742	X10CrAl18	Z10CAS18		F.3153-X 10 CrAl 18	430
		1.4762	X10CrAl24	Z10CAS24		F.3154-X 10 CrAl24	446
	303S21	1.4305	X10CrNiS189	Z10CNF18.09	2346	F.3508-X10CrNiS18-09	303
	304S15	1.4301	X5CrNi1810	Z6CN18.09	2332	F.3451-X5 CrNi18-10	304/304H
	305S19	1.4303	X5CrNi1812	Z8CN18.12		F.3513-X8CrNi18-12	308; 305
	304S12/S11/CC12	1.4306	G-X2CrNi189/1911	Z2CN18.10/Z3CN19.10M	2333/52	F.3503-X 2CrNi19-10	304L
	304C15	1.4308	G-X6CrNi189	Z6CN18.10M	2333		CF-8
	301S21	1.431	X12CrNi177	Z12CN17.07		F.3517-X12CrNi17 07	301
	304S62	1.4311	X2CrNiN1810	Z2CN18.10Az	2371		304LN
	425C11	1.4313	G-X5CrNi134	Z4CND13.4M	2385		CA6-NM
	316S16/S31	1.4401	X5CrNiMo17122	Z6CND17.11	2347	F.3543-X5CrNiMo17-12/-03	316/316L
	316S11/S12	1.4404	X2CrNiMo17132	Z2CND 18.13	2348	F.3533-X 2CrNiMo17 12-03	316L
	316S61	1.4406	2CrNiMoN17122	Z2CND 17.12Az			316LN
	316C16	1.4408	G-X6CrNiMo1810		2343	F.8414-AM-X7 CrNiMo20 10	CF-8M
	316S62	1.4429	X2CrNiMo17133	Z2CND17.13Az	2375		316LN
	316S11/S12	1.4435	X2CrNiMo18143	Z2CND17.13	2353	F.3533-X 2 CrNiMo 17-12-03	316L
	316S16	1.4436	X5CrNiMo17133	Z6CND17.12	2343	F.3534-X 6 CrNiMo 17-12-03	316
	317S12	1.4438	X2CrNiMo18164	Z2CND19.15	2367		317L
	317S16	1.4449	X5CrNiMo1713				317
	347C17	1.4452	G-X5CrNiNb189	Z6NNb18.10M			
		1.446	X8CrNiMo275		2324	F.3309-X 8CrNiMo27-05	329
	321S12S31	1.4541	X6CrNiTi1810	Z6CNT18.10	2337	F.3553-X 7 CrNiTi 18-11	321
		1.4542	X5CrNiCuNb1714	Z6CNU17.04			630
	347S17/S18	1.4546	X5CrNiNb1810				348
	347S17/S31	1.455	X6CrNiNb1810	Z6CNNb 18.10	2338	F.3552-X 7 CrNiNb 18-11	347
	320S31/S17	1.4571	X6CrNiMoTi17122	Z6CNDT17.12	2350	F.3552-X 6 CrNiMoTi17-12-03	316Ti
	318S17	1.458	X6CrNiMoNb17122	Z6CNDNb17.12/19.13			316Cb
	318C17	1.4581	G-X5CrNiMiNb1810	Z4CNDNb18.12M			
	309S24	1.4828	X15CrNiSi2012	Z15CNS20.12			309
	309S24	1.4833	X7CrNi2314	Z15CN24.13			309S
	309C30	1.4837	G-X40CrNiSi2520				
		1.4841	X15CrNiSi2520	Z15CNS25.20		F.3310-X15 CrNiSi 25-20	314/310
310S24	1.4845	X12CrNi2521	Z12CN25.20	2361	F.331	310S	
310C40	1.4848	G-X40CrNiSi2520			F.8452-AM-X 40 CrNi25 20	HK	
349S54	1.4871	X53CrMnNiN219	Z52CMN21.09		F.3217-X 53 CrMnNiN 21-09	EV8	
331S40	1.4873	X45CrNiW189	Z35CNWS14.14		F.3211-X45 CrNiSiW 28-09		
321S20	1.4878	X12CrNiTi189	T6CNT18.12(B)	2337	F.3523-X 6CrNiTi 18 11	321	
1501-509;510	1.5662	X8Ni9	Z8N9		F.2645 - X 8 Ni 09	A353	
	1.568	12Ni19	Z18N5			2515	
HIGH TEMPERATURE ALLOYS	NA 18	2.4375	NiCu30 Al	NU 30 AT			Monel k-500
		2.4685	G-NiMo28				Hastelloy B
		2.481	G-NiMo30				Hastelloy C
		2.461	NiMo16Cr16Ti				Hastelloy C-4
	NA 16/3072-76	2.4858	NiCr21Mo	NC 21 Fe DU			Incoloy 825
		2.4694	NiCr16Fe7TiAl				Inconel
NA 21	2.4856	NiCr22Mo9Nb	NC 22 FeDNb			Inconel 625	







Material cross reference chart

Tableau de correspondance des matières | Tabelle mit Materialbezeichnungen
Tabella di comparazione dei materiali | Tabela materiałów

	UK	German DIN	French	Swedish	Spanish	USA
HIGH TEMPERATURE ALLOYS		2.4856				Inconel 625
		2.4642	NiCr29Fe	Nnc 30 Fe		Inconel 690
		2.4668	NiCr19FeNbMo	NC 19 Fe Nb		Inconel 718
		2.4669	NiCr15Fe7TiAl	NC 15 TNb A		Inconel X-750
						Invar 36-36 Alloy
						Invar Super 32-5
						Invar Super 32-5
	NA 13	2.436	NiCu30Fe	NU 30		Monel 400
	X5NiCrTi26 15				HR650	A286
			Co28Cr6Mo	Z6CNU15-5		Co Chrome ASTM F-75
	NA17	1.4864	X12NiCrSi3616	Z12NCS37.18		330
	NA15(H)	1.4876	X10NiCrAlTi3320	Z8NC3221		F.3313-X 12 CrNi 36-16
	3072-76/NA13	2.436	NiCu30Fe	NU30		F.3545-X 9NiCr 33-21
	3072-76/NA18/3146	2.4375	NiCu30Al			4544/SB127/164
		2.4602	NiCr17Mo17FeW	NC 17 DWY		4676
	HR5/203-4/703-B	2.463	Ni-Cr20Ti	NC 20 T	MH-05	5388 C
	HR 10	2.465	NiCr20Co19MoTi	NCK 20 D		Nimonic 75
		2.4662	NiCr15MoTi	Z8 NCDT 42	MH-16	5660C
	HR 6/204	2.4665	NiCr22Fe18Mo	Nc 22 FeD	MH-03	5536E
	HC 203	2.467	G-NiCr13Al6MoNb	NC 13 AD	MH-31	5391A
	HC 204	2.4674	NiCo15Cr10MoAlTi	NK 15 CAT		
	3072-76	2.4816	NiCr15Fe	NC 15 Fe		5540
		2.4856	NiCr22Mo9Nb	NC 22 FeDNB		5581
	3072-76	2.4858	NiCr21Mo	NC 21 FeDU		
	HR 207/5047		NiFe33Cr17Mo	NW 11 AC		
			NiCo32Cr26Mo	KC 20 WN		
			NiCo28Cr15MoAlTi	NK 27 CADT		
	HR 3/5007	2.4634	NiCo20Cr15MoAlTi	NCKD 20 ATV	MH-14	
	2.4654	NiCr20Co14MoTi	NC 20 K 14			
HR 505	2.4669	NiCr16FeTi	NC 15 Fe TNb		5542G	
	2.4676	NiCo10W10Cr9AlTi				
		NiCr20Co16MoTi	NC 19 KDU/V			
		NiW13Co10Cr9AlTi	NKW 10 CAT ahf			
		NiCr16Co10WAlTi				
HR 401HR601/736B	2.4631	NiCr20TiAl	NC 20 TA	MH-07		
	2.4636	NiCo15Cr15MoAlTi	NCKD 20 AT		687	
	2.4662	NiFe35Cr14MoTi	Z8 NCDT 42			
HR 8	2.4668	NiCr19Fe19NbMo	NC 19 FeNb	MH-06		
	2.4916	NiCr19Co11MoTi				
	2.4983	NiCr18Co18MoAlTi	NCK 19 DAT		684	
		NiCo22Cr16WAlTi	NC 14 K8			
TITANIUM	TA.1	3.7024/25	Ti 99,8	T-35		Ti-PO1
	TA.2/3/4/5	3.7034/35	Ti 99,7	T-40		Ti-PO2
	TA.6/7/8/9	3.7064/65	Ti99,5	T-60		4941/42/51/4902
	TA.21-24/52-55/58	3.7124	TiCu2	T-U2		Ti-PO4
	DTD 5023/5273/5283			T-50		4901/21
		3.7114	TiAl5Sn2 5553			4900
	TA.43/44	3.7154	TiAl6Zr5Mo0,5Si0,2	T-A6ZD		Ti-5Al-2.5Sn
	TA.10-13/28/56	3.7164/65	TiAl6V4	T-A6V		Ti-5Al-5V-5Mo-3Cr
TA.45-51/57	3.7184	TiAl4Mo4Sni2Si0,5	T-A4DE			
NODULAR CAST IRON	420/12	0.704	GGG-40	FGS-400-12	0717-02	60-40-18
	370/17	0.7043	GGG-40.3	FGS370-17	0717-15	
	500/7	0.705	GGG-50	FGS500-7	0727-02	65-45-12
	600/3	0.706	GGG-60	FGS 600-3	0732-03	80-55-06
	700/2	0.707	GGG-70	FGS 700-2	0737-01	100-70-03
	800/2	0.708	GGG-80	FGS 800-2		120-90-02
	W 340/3	0.8035	GTW-35-04	MB 35-7		
	W 410/4	0.804	GTW-40-05	MB 40-10		
	B 340/12	0.8135	GTS-35-10	MN 35-10	SIS 08 15-00	32 510
	P 440/7	0.8145	GTS-45-06	MP 50-5	SIS 08 54-00	
	P 540/5	0.8155	GTS-55-04	MP 60-3	SIS 08 56-00	
	P 690/2	0.817	GTS 70-02	MP 70-2	SIS 08 62-03	70 003
B 290/6			MN 32-8/38-18	SIS 08 14-00		
GREY CAST IRON	Grade 150	0.601	GG10	Ft10D / FGL100	0110-00	FG 10
	Grade 220	0.6015	GG15	Ft15D / FGL150	0115-00	FG 15
	Grade 260	0.602	GG20	Ft20D / FGL200	0120-00	FG20
	Grade 300	0.0625	GG25	Ft25D / FGL250	0125-00	FG 25
	Grade 350	0.603	GG30	Ft30D / FGL300	0130-00	FG 30
	Grade 400	0.6035	GG35	Ft35D / FGL350	0135-00	FG35
	Grade 450	0.604	GG40	Ft40D / FGL400	0140-00	FG35
ALUMINIUM ALLOYS	LM4/LM22	3.2151	G-ALSi6Cu4	A-55U	4230	L-2660
	2L99/LM25	3.2371	G-ALSi7Mg	A-57G0,3	4244	319,2
	LM24	3.2161	G-ALSi8Cu3	A-59U3	4252	A356.2
	LM9	3.2381	G-ALSi10Mg	A-510G	4253	L-2630
	LM20	3.2583	G-ALSi12Cu	A-512U	4260	L-2560
	LM6	3.3581	G-ALSi12	A-513	4261	L-2530

Material cross reference chart

Tableau de correspondance des matières : Tabelle mit Materialbezeichnungen
 Tabella di comparazione dei materiali : Tabela materiałów

							
	UK	German DIN	French	Swedish	Spanish	USA	
ALUMINIUM ALLOYS	LM28/LM29		AlSi18-25CuNiMg			393	
	1C	3.0205	Al99	A4	144010	L-3001 1200	
	1B	3.0255	Al99,5	A5	144007	L-3051 1050A	
	1E	3.0257	E-Al	A5/L	144008	L-3052 1350A	
	1A	3.0285	Al99,8	A8	144004	L-3081 1080A	
	1	3.0385	Al99,98R	A99			1199
	N31	3.0505	AlMn0,5Mg0,5				3105
	N3	3.0515	AlMn		144054	L-3810	3103
		3.0525	AlMn1Mg0,5	A-M1G0,5			3005
	N4	3.0526	AlMnMg1	A-M1G		L-3820	3004
		3.0915	AlFeSi	A-FeS			8011A
	H15	3.1255	AlCuSiMn	A-U4SG	144338	L-3130	2014
		3.1303	AlCu2Mg0,5				2036
	3L86/HR13	3.1305	AlCu2,5Mg0,5	A-U2G		L-3180	2117
	H14	3.1325	AlCuMg1	A-U4G		L-3120	2017A
	2L98	3.1355	AlCuMg2	A-U4G1		L3140	2024
		3.1645	AlCuMgPb	A-U4Pb	144335	L-3121	2003
	FC1	3.1655	AlCuBiPb	A-U5PbBi	144355	L-3182	2011
	2L91/92	3.1841	G-AlCu4Ti				295,1/.2
	91E	3.2305	E-AlMgSi			L-3431	6101B
	BTR6	3.2307	Al99,85MgSi	A85-GS			6463
	H30	3.2315	Al-Si1 Mg	A-SGMO,7	144212	L-3451	6181
	H9	3.3206	AlMgSi0,5		144103	L-3441	6060
	BTR6	3.3207	E-AlMgSi0,5	A-GS/L	144102		6101C
		3.3241	G-AlMg3Si	A-G3T			FB514.0
	N41	3.3315	AlMg1	A-G0,6	144106	L-3350	5005A
	3L44	3.3316	AlMg1,5	A-G1,5		L-3380	5050B
	BTR2	3.3317	Al99,85Mg1	A85-G1			
		3.3326	AlMg1,8				5051A
		3.3345	AlMg4,5				5082
	N5Mg3,5	3.3523	AlMg2,5	A-G2,5C	144120	L-3360	5052
	N4	3.3525	AlMg2Mn0,3	A-G2M			5251
		3.3527	AlMg2Mn0,8				5049
		3.3535	AlMg3	A-G3M	144133	L-3390	5754
	N51	3.3537	AlMg2,7Mn	A-G2,5MC			5454
		3.3541	G-AlMg3	A-G3T		L-2341	514
		3.3545	AlMg4Mn	A-G4MC		L-3322	5086
	N8	3.3547	AlMg4,5Mn	5083	144140	L-3321	5083
	N6	3.3555	AlMg5		144146	L-3320	5056A
	LM5	3.3561	G-AlMg5	A-G6			514.1
	LM10	3.3591	G-AlMg10	A-G10-Y4		L-2310	520
	H17	3.4335	AlZn4,5Mg1	A-Z5G	144425	L-3741	7020
		3.4345	AlZnMgCu0,5	A-Z5GU0,6			7022
		3.4365	AlZnMgCu1,5	A-Z5GU		L-3710	7075
		3.4415	AlZn1			L-3721	7072
COPPER ALLOYS	Pb2	2.1052	G-CuSn12	CuSn12		C 90800	
	CT2	2.106	G-CuSn12Ni			C 91700	
	CT1	2.1086	G-CuSn10			C 90250	
		2.109	G-CuSn7ZnPb	CuSn7Pb6Zn4		C 93200	
	LG4	2.1093	G-CuSn6ZnNi			C 92410	
	LG2	2.1096	G-CuSn5ZnPb/RG5	CuPb5Sn5Zn5		C 83600	
	LG1	2.1098	G-CuSn2ZnPb			C 83810	
	LB2	2.1176	G-CuPb10Sn	CuPb10Sn10		C 93700	
	LB1	2.1182	G-CuPb15Sn			C 93800	
	LB5	2.1188	G-CuPb20Sn	CuPb20Sn5		C 94100	
		2.0918	CuAl5As	CuAl6		C 60 800	
		2.092	CuAl8	CuAl8		C 61 000	
	CA 106	2.0932	CuAl8Fe3	CuAl7Fe2		C 61 400	
	CA 105	2.0936	CuAl10Fe3Mn2	CuAl9Fe3Mn2		C 62 300	
	AB 1	2.094	CuAl10Fe	CuAl9Fe3		C 95 200	
	CA 104	2.0966	CuAl10Ni5Fe4	CuAl9Ni5Fe3Mn		C 63 200	
	AB 2	2.097	G-NiAlBzF50	CuAl9Ni5Fe		C 95 800	
	CC 102	2.1293	CuCrZr			C 18100	
	C 112	2.1285	CuCo2Be			C 17500	
	CB 101	2.1245	CuBe1,7	CuBe1,7		C 17000	

Coatings

ALtima®

Aluminium Titanium Nitride (AlTiN). ALtima® is the original high performance coating. This coating allows tools to be run at higher speeds and feeds in a wide array of materials. Also, it allows the option of running tools dry due to the high oxidation temperature of the coating.

ALtima® Plus

This Aluminium Titanium Nitride (AlTiN) multi-layer coating has optimized coating structure, with pre and post treatment of the coating for optimized high performance drilling in any ferrous material.

ALtima® 52

Aluminium Titanium Nitride (AlTiN). ALtima® 52 is specially designed for milling hardened steels 52 Rc and above. It has very high hardness and the oxidation temperature of the coating makes this the absolute best choice for hardened steel milling. ALtima® 52 is designed to allow for dry machining.

ALtima® Blaze

ALtima® Blaze is designed to allow higher material removal rates. This coating has a higher oxidation temperature than a typical TiAlN coating.

It has shown very good results in nickel alloys, titanium, and other difficult to machine materials. Tools coated with ALtima® Blaze can be used in dry machining.

Special Coatings

Upon request, M.A.Ford® can provide any commercially available coating. Any standard M.A.Ford® cutting tool can be provided with coating if requested.

Fordlube

Titanium DiBoride (TiB₂) is a unique coating with low Aluminium affinity, smooth surface finish and high hardness. It is ideal for Aluminium and Magnesium alloys as it prevents build-up on cutting edge, provides superior chip flow along with extended wear resistance.

CERAedge® combines the heat resistance of conventional AlTiN coatings with the hardness and smoothness of amorphous diamond coatings.

- Hardness that makes it the 3rd hardest material when compared to industrial diamonds
- Toughness that is comparable to Titanium
- Lubricity that approaches Teflon

Applications-

- **Only CERAedge® has properties allowing for ideal drilling and milling of Titanium clad composites**
- **Ideal for machining Titanium, Aluminium Alloys and High Silicon Aluminium materials.**

Coating Properties

M.A. Ford Coating	M.A. Ford Tool Number Designation	Microhardness (HV)	Maximum Service Temp.	Friction Coefficient
ALtima®	A	3100	1100°C / 2012°F	0.42
ALtima® Plus	AP	3200	1100°C / 2012°F	0.25
ALtima® 52	A	3600	1200°C / 2192°F	0.4
ALtima® Blaze	B	3200	1100°C / 2012°F	0.35
ALtima® Xtreme	AX	3800	1100°C / 2012°F	0.3 - 0.5
ALtima® Nano	AN	3875	1100°C / 2012°F	0.3
TiN	T	2300	600°C / 1112°F	0.4
TiCN	C	3000	400°C / 752°F	0.4
Fordlube	F	4000	700°C / 1292°F	0.3
Gem+	GP	4710	500°C / 932°F	0.3
CERAedge®	CE	3400	1100°C / 2012°F	0.25

Gem+

Recommended for aluminium and aluminium alloys up to 12% Si, non-ferrous metals and composites. Gem+ provides excellent wear resistance and maintains sharp cutting edges.

TiN

Titanium Nitride (TiN). TiN coating has shown good results in low carbon steels and many iron-based applications. It is a very popular coating used in the industry today.

TiCN

Titanium Carbonitride (TiCN). TiCN is a multi-layer coating because of the multi-layer composition, TiCN is tougher than TiN, even though TiCN is harder. The added toughness of the TiCN coating makes it a good choice for mechanically stressed edges like in end mill applications. The higher hardness makes TiCN a good choice for abrasive applications where higher wear resistance is required.

ALtima® Xtreme

ALtima® Xtreme is a high heat resistant coating with smooth surface to reduce chip re-welding. First choice in Hardened Steels, Stainless Steels and Heat Resistant Alloys like Inconel 718.

ALtima® Nano

ALtima® Nano is a high performance coating providing excellent heat resistance in high temperature machining, especially in Titanium and Stainless Steel. It provides improved adhesion, shock resistance and excellent coating smoothness.



Integrated Manufacturing Solutions



M.A.Ford® World Class Cutting Tools



REGO-FIX® powRgrip® Precision Toolholding

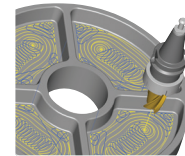

HSM Tool Path Optimisation

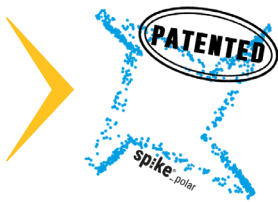

Spike® TDS Cutting Tool Force Mapping



TMS Tool Management System



Technical Support & Advice

Take control of your machining processes with IMS

Integrated Manufacturing Solutions, IMS for short, combines a range of complementary technologies from M.A. Ford, including our high-performance tooling, which combine to help optimise machining and enhance productivity.

Recently extended with the addition of Spike® TDS tool force mapping and

TMS automated tool management, IMS also incorporates HSM tool path optimisation software and REGO-FIX® precision tool holding, as well as our extensive cutting tool range and unrivalled technical support.

IMS – Providing solutions for manufacturing challenges.

For further information please contact our support team on: 01332 267960

▶ Custom tools with customised service



There are some applications where only a dedicated special purpose tool is the best solution.

Our Custom Tools Division gives you the best of both worlds by providing you with the facilities to design and manufacture a special tool to your exact requirements, but with the added advantage of being precision manufactured by M.A. Ford Europe.

**Performance and peace of mind.
A perfect combination.**



EXPRESS
Special Tools in 7 days*

Contact us now: 01332 267960 or
Email: customtools@mafordeurope.com

* Terms & conditions apply.

▶ **REGO-FIX®** powRgrip®

As an authorised UK REGO-FIX distributor, we can offer you the ultimate combination in high performance cutting tools and tool holding solutions.

The figures speak for themselves:

REGO-FIX powRgrip® tool holding system with secuRgrip® option for 100% security against tool pull-out

- ▶ Holders guaranteed for life under normal usage of 20,000 insertion/extraction cycles of collet without deterioration in clamping force
- ▶ ≤ 3µm run-out
- ▶ Designed for roughing and finishing operations
- ▶ Anti-vibration effect over standard shrink-fit allowing increased tool life and cutting parameters



Perfect for HA & HB shanks

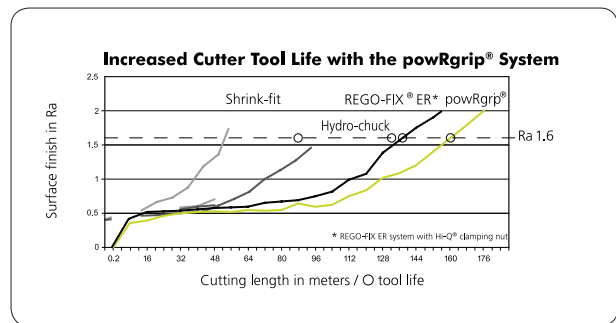
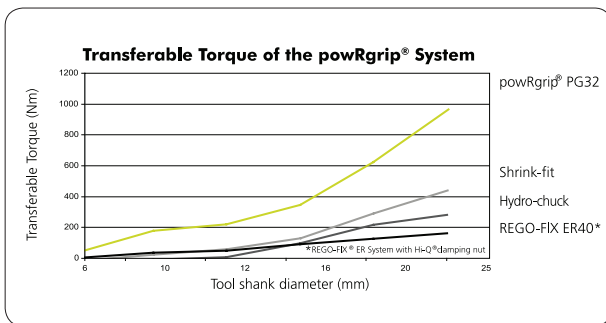

For further information please contact our support team on: 01332 267960

FordGrip Power Chuck

FordGrip Power Chuck range of collet chucks provides manufacturers with a high precision and cost-effective tool holding solution that allows optimum tool performance to be achieved

- High gripping force ensures tool security
- Accurate tool runout (0.005mm at 3xØ) increases tool-life and improves surface finish
- Suitable for plain, Weldon and whistle notch shank end-mills and drills (Weldon and whistle notch must be used with reduction sleeves)
- Simple mechanism allows easy opening and closing with no maintenance
- Reduced length and external dimensions for improved balancing (G2.5 to 25,000rpm)
- Suitable for through coolant tools



M.A. FORD GRIP
POWER CHUCK

M.A. FORD GRIP
HYDRAULIC MILLING CHUCK

For further information please contact our support team on: 01332 267960

Optimised Cutting

High Speed Machining (HSM)



Since producing our first cutting tools in 1919, M.A. Ford has always striven to improve customer productivity and reduce costs.

The TuffCut® XR-XT range of end mills is the latest step in this process, offering unique Heli-pitch geometry, proprietary substrates and state of the art ALtima® coatings.

HSM uses cutting speeds that are typically more than double those of standard or conventional techniques. In conjunction with the increase in surface speed, by controlling the cutting tool engagement angle during the milling process, and the use of chip thickness compensation, increased cutting data can be achieved.

Before using these techniques there are several requirements to consider:

- Rigid machine tools with modern control systems with a HSM function.
- High performance, high technology cutting tools.
- High gripping strength, rigid tool holders.
- Air or powerful coolant delivery system-according to material being machined.
- CAD/CAM software to control the engagement angle of the tool.

We can show you how!

M.A. Ford utilises class leading CAD/CAM software which allows for exact control of the radial depth engagement, which is crucial to the high speed machining process.

A step over of 10% of the cutter diameter requires a chip thickness compensation factor of 1.8 to be applied. 20% radial engagement requires a compensation of 1.2 times. However, care must be taken when using these rates for tight corner internal machining.

Due to the small radial cuts, large axial cuts – typically 2 times the tool diameter can be used. The combination of these factors enables most steels up to 40HRC to be machined at feeds of up to 13 m/min. An example of this HSM cutting data can be seen on the next page in a direct comparison with conventional programming techniques.

Benefits of HSM:

- Decreased cycle time
- Reduced costs
- Potentially reduced cutting tool diameter and hence cost
- Improved process reliability
- Improved cutting tool life
- Reduced coolant consumption

For further information please contact our support team on: 01332 267960

Benefits of Enhanced Cutting Parameters with HSM Toolpaths

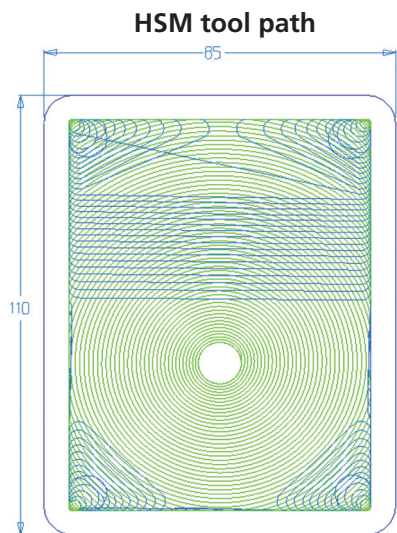

Tool diameter-12 mm 177 1200-0.5RA
 Entry-Helical ramp-2 degrees
 Axial depth Ap-24 mm-1cut
 Radial step over Ae-10%-1.2 mm

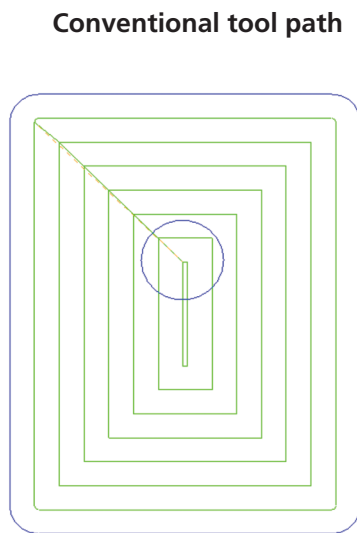

Tool diameter-12 mm 177 1200-0.5RA
 Entry-Via drilled hole.
 Axial depth Ap-24 mm-2 cuts of 12 mm
 Radial step over Ae-50%-6 mm

Cutting data and cycle time by material

Steel		
RPM	8000	3200
Feed mm/min	6700	765
Cycle time	1 min-40 secs	4 mins
Metal removal rate	193 cm ³	55 cm ³
Expected tool life	2 - 3hrs	1 - 2hrs

Stainless Steel		
RPM	4000	1855
Feed mm/min	3400	450
Cycle time	3 min-20 secs	7 mins
Metal removal rate	98 cm ³	32 cm ³
Expected tool life	2 - 3hrs	1 - 2hrs

Titanium		
RPM	2600	1600
Feed mm/min	2100	380
Cycle time	5 min-15 secs	8 mins
Metal removal rate	61 cm ³	27 cm ³
Expected tool life	2 - 3hrs	1 - 2hrs

Inconel 625		
RPM	930	660
Feed mm/min	470	80
Cycle time	21 mins	37 mins
Metal removal rate	14 cm ³	6 cm ³
Expected tool life	30 mins - 1 hr	15 - 30 mins

Spike[®] cutting force monitoring

As part of our Integrated Manufacturing Solutions (IMS) programme, the Spike[®] cutting force monitoring system enables us to provide customers with optimised performance data derived from their own applications.

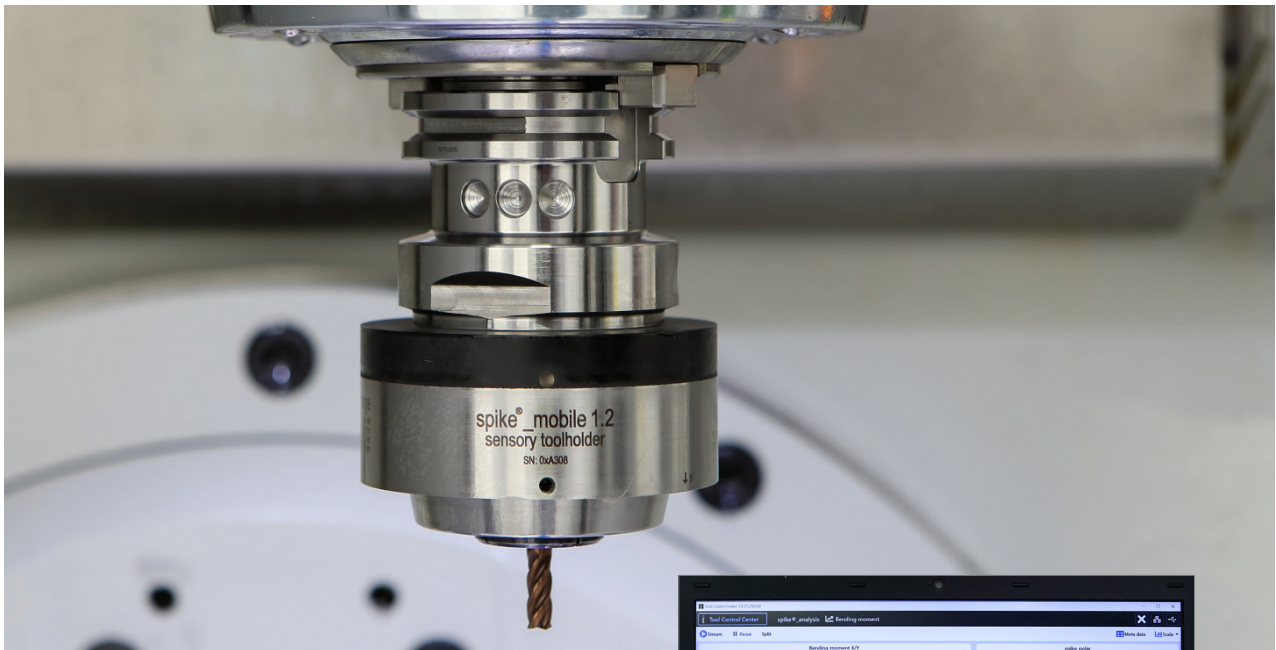

By monitoring tension/pressure, torsion and bending moment in real time, Spike[®] allows the effects of changes in parameters, such as speed, feed and depth of cut to be instantly viewed and analysed by the software.

The results are then displayed as graphic and numerical data, which enables tooling to be optimised to specific machining conditions or requirements.

At M.A. Ford Europe, we also use the system as an integral part of our tool development programme to analyse the effects that edge geometry, carbide and coating variations have on tool performance in any material. This allows us to deliver a high-performance solution backed up by robust data.

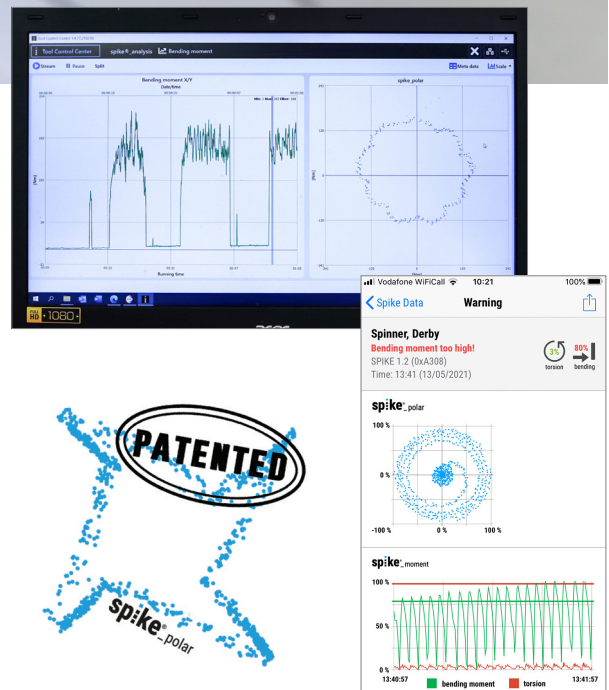

For further information please contact our support team on: 01332 267960

TMS - Automated tool management systems

Tooling and inventory management at the push of a button

Our versatile TMS range of tool management and inventory control machines provide M.A. Ford customers with a fully automated and cost effective-stock control solution on-site at the point of use.

TMS is easy to use and provides a simple method of managing tool usage and consumption while controlling stock and manufacturing costs, all at the push of a button.

All TMS machines are linked to an online portal, allowing customers to generate a wide range of inventory and usage reports to help manage cutting tool expenditure and monitor costs in detail.

The system automatically generates purchase orders for replenishment stock, or new products, direct to M.A. Ford Europe.

TMS options

TMS-CS

This range uses multi-tier stacked carousels, which are segmented into different 'cells' that can be configured for different sized items. They are loaded with single tools or multiple items, if required, each with their own location code. When the correct code is entered the carousel rotates and the access door automatically unlocks when the tool is available for collection.

TMS-DS

Our TMS-DS models are configured as stacked drawers. Each drawer contains a number of compartments, which can be configured to meet the specific needs of each customer. Once the unique location code is entered on the keypad, the appropriate drawer will open and the individual item will be available for use.



Why TMS?

Greater control

Control tooling costs, production and inventory easily while accessing a range of dedicated and detailed usage reports online, as well as automated replenishment.

Easy to configure

The divider system allows items to be added or removed in minutes, giving great flexibility and time savings.

Software and flexible system integration

Our powerful software can manage a single TMS unit or banks of machines, giving the flexibility of assigning them as a master or 'slave' unit.

Small footprint and easy location

The small footprint allows TMS solutions to be located close to the point of use in production areas as well as specialised dedicated manufacturing cells.

Secure access at any time

Round the clock traceable access using keypad log-in, proximity or biometric methods for authorised users.

No Spirals - No Drop

TMS carousel and drawer options do not use rotating spirals so there's no drop and items can easily be returned, if required.

High capacity

More than 800 individual SKUs can be stocked in a single TMS machine.

For further information please contact our support team on: 01332 267960

▶ Technical Support & Advice

Like the cutting edge performance offered by our tooling, the high quality standards provided by our technical support team are an integral part of our business and an essential link for our customers.

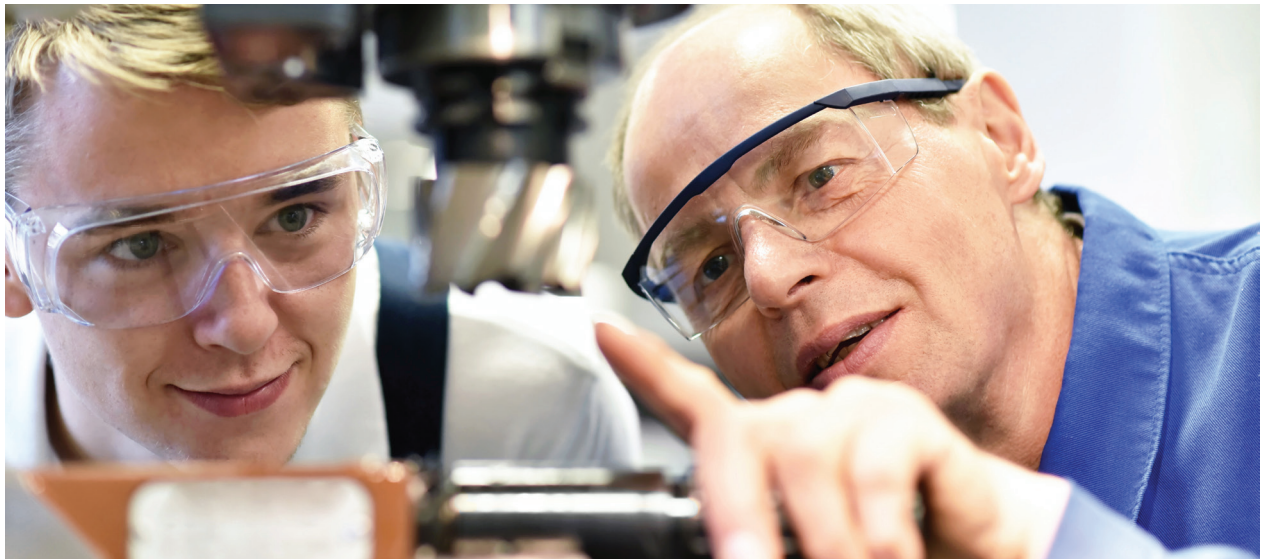

Whether it's a simple product performance or tool selection query or a complex question about a new tooling application or improving machining performance, our technical support team has the expertise, experience and knowledge to advise and help.

At M.A. Ford Europe, service and technical support is not just a function of our business, it's a fundamental part of what we do and how we work together with customers to deliver the best solutions for their machining and manufacturing operations.

In addition to guidance and advice, our team can also provide training at our Technical Centre or at customers' premises, application & tool testing to verify performance, as well as support for every element within our Integrated Manufacturing Solutions (IMS) programme.

Where a unique cutting solution is required, we also support customers through our own specialist Custom Tools Division, which is dedicated to the design & manufacture of custom tools and innovative solutions to meet individual customer specifications.

For further information please contact our support team on: 01332 267960

The M.A. Ford interactive cutting data app

- Everything you need at your fingertips

Our interactive app for iOS and Android devices makes tool cutting data calculations simpler and faster by minimising text input and using 3D graphics that respond instantly to changing cutting parameters, using smart-phone or tablet touch screens.

Developed around our proven cutting data, the app supports a wide range of ISO materials including steel, aluminium alloys, stainless steel and titanium, as well as cast iron, hardened steels and exotic alloys.

Once basic information has been selected from 'drop down' menus, such as tool type, diameter and material, the app allows you to 'drag' the tool graphic display to change the radial engagement and depth of cut, which instantly calculates speeds and feeds.

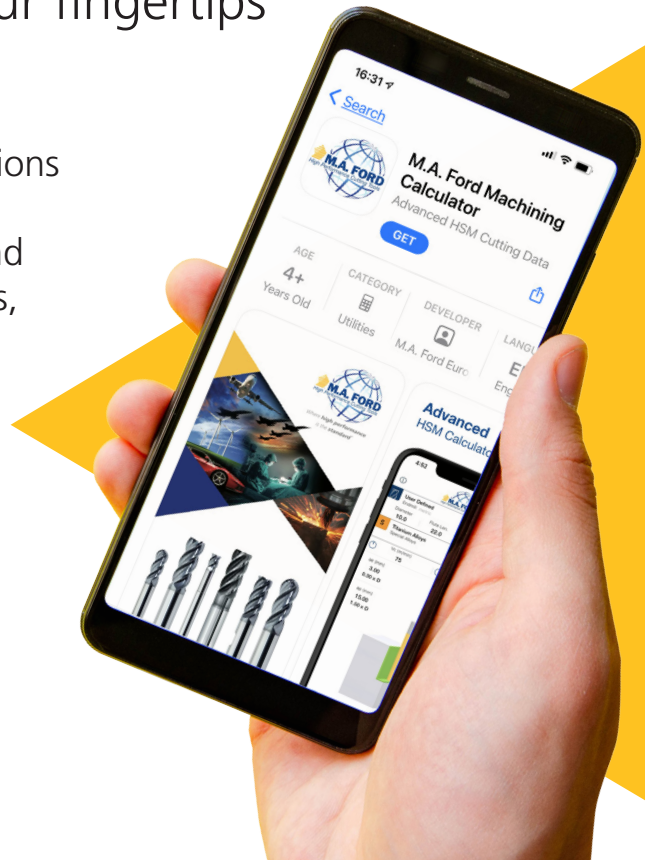

Colour coded feedback guides you toward the recommended cutting conditions based on the chosen input parameters. User over-ride controls allow cutting data to be fine-tuned for individual applications, as well as enabling calculations to be made that compare multiple scenarios instantly.

Proven cutting data can be stored via the 'Save' feature for future reference or shared with other app users. A hyperlink to M.A. Ford Europe's website also allows immediate access to online information and downloads.

Radial chip thinning data is also calculated for use with high-speed machining (HSM) strategies, which can significantly reduce cycle times and improve tool life.



For further information please contact our support team on: 01332 267960

Where **high performance**
is the **standard**



TuffCut® Endmills

CYCLONE Drills

Countersinks

Twister® Drills

Edgehog® Burrs

TrueSize® Reamers

Diamond Grind Routers

M.A. Ford Europe Ltd.

650 City Gate
London Road, Derby
DE24 8WY
United Kingdom

Tel: +44(0) 1332 267960
Fax: +44(0) 1332 267969
e-mail: sales@mafordeurope.com
www.mafordeurope.com

M.A. Ford® Mfg. Co., Inc.

7737 Northwest Blvd.
Davenport,
IA 52806
USA

Tel: 563-391-6220 or 800-553-8024
Fax: 563-386-7660 or 800-892-9522
e-mail: sales@maford.com
www.maford.com

M.A. Ford® Asia-Pacific Limited

Room 1709, Level 17
Millennium City 2
378 Kwun Tong Road
Kowloon, Hong Kong

Tel: +852-2167-7150
Fax: +852-2167-8150
Email: sales@mafordap.com